

0,5h

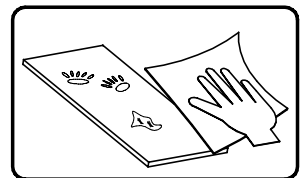

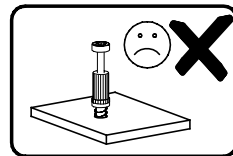

nr	L[mm]	B[mm]	T[mm]	Menge	Colli
1	920	770	19	1	1/2

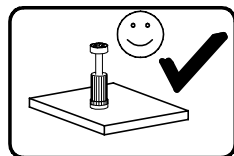
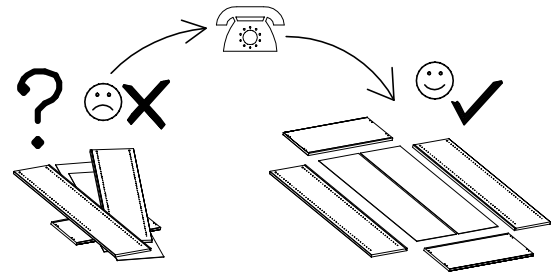
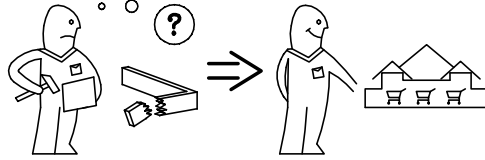
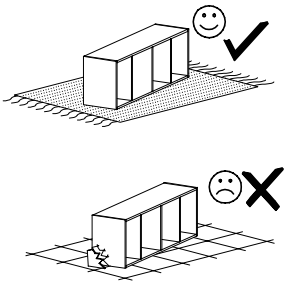
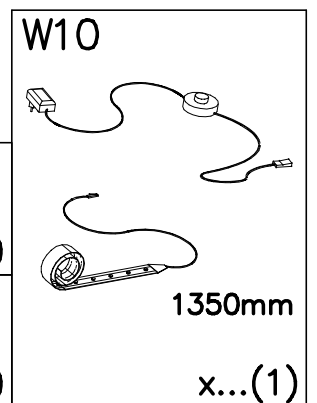
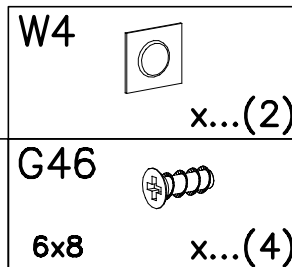
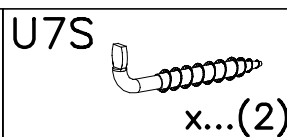
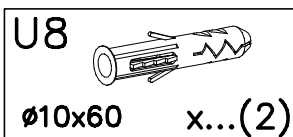
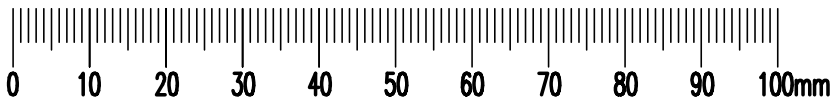
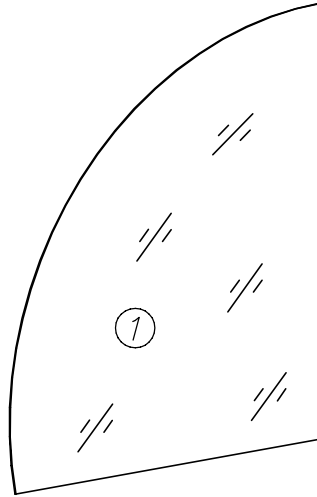



I



G46



6x8

x...(4)

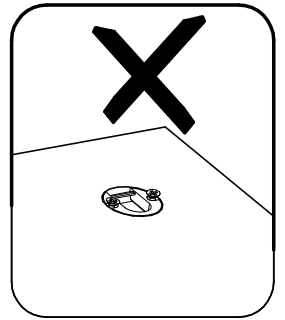
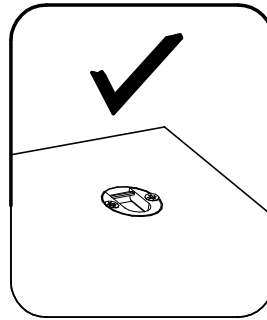
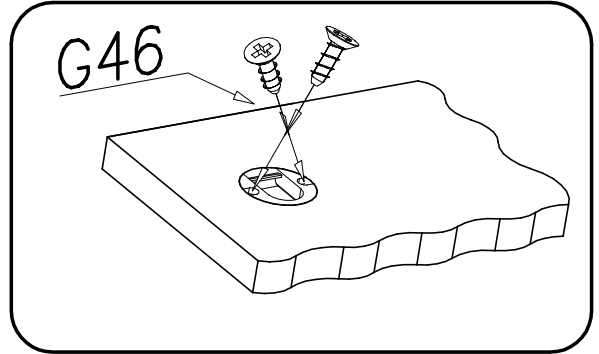
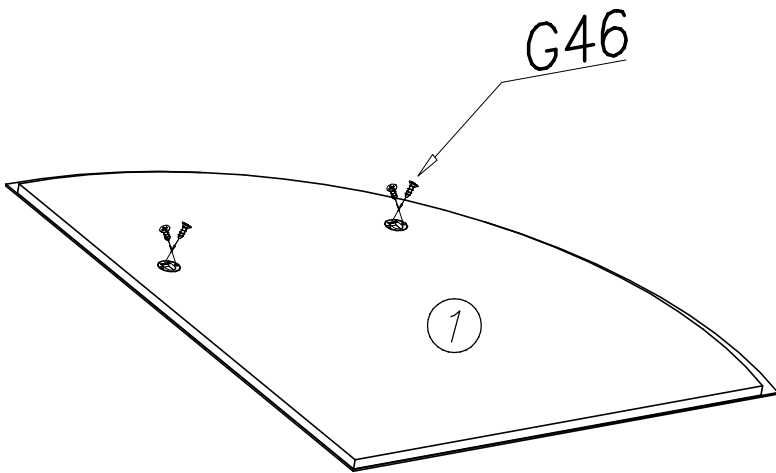

II

W4



2x

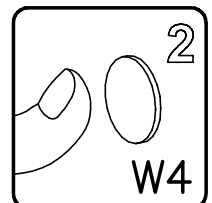
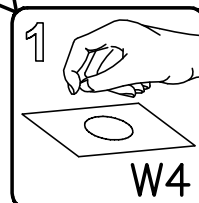
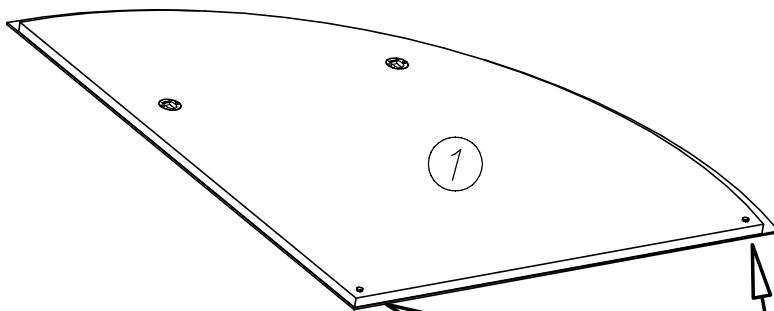



III

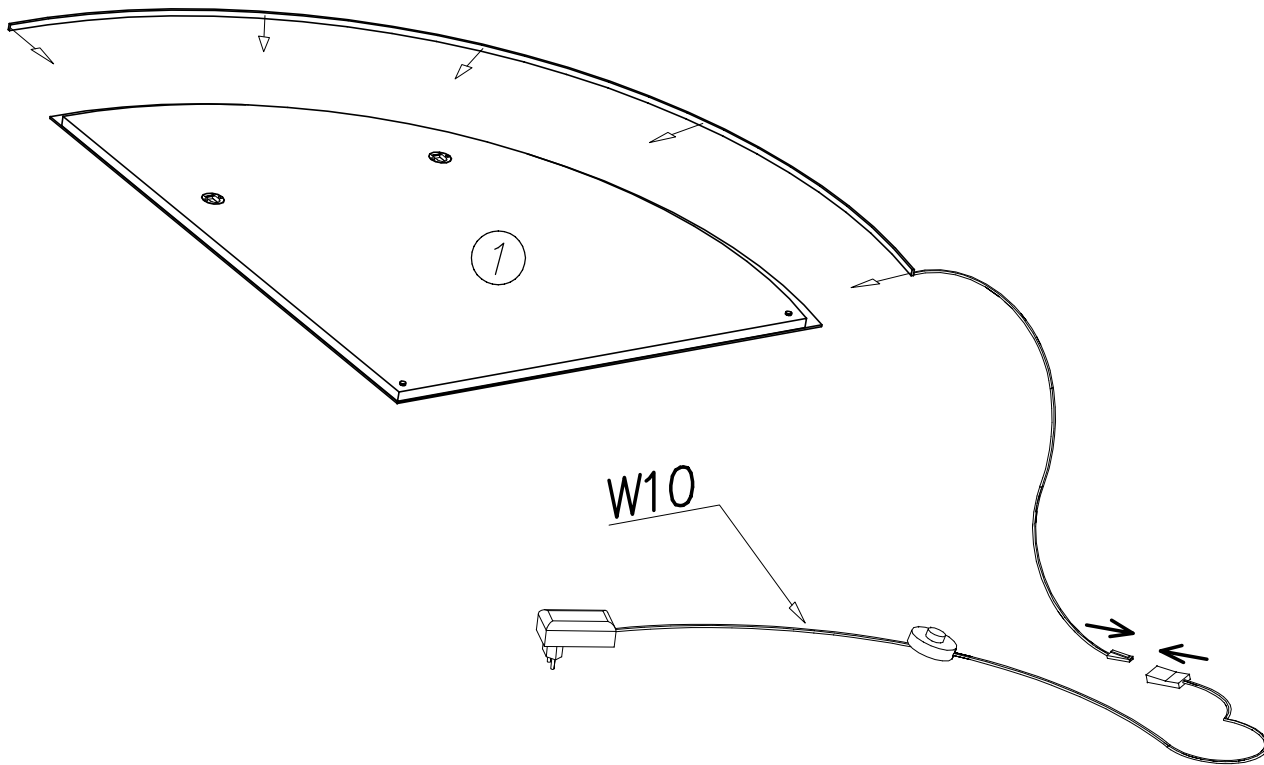
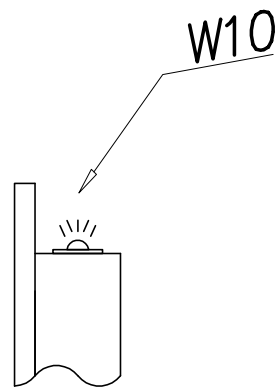
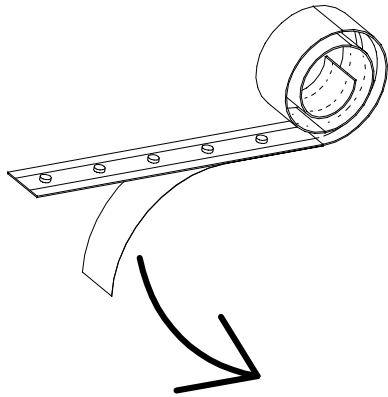



# IV

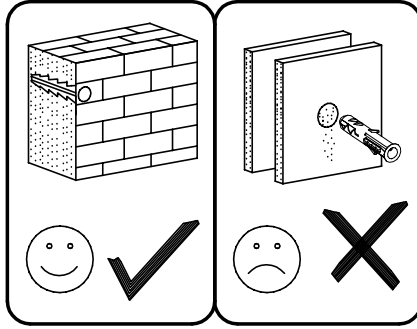

1

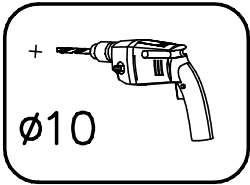

2

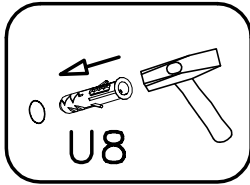

3

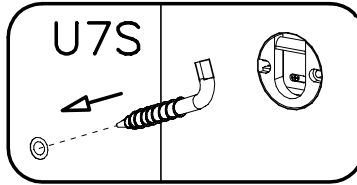

4

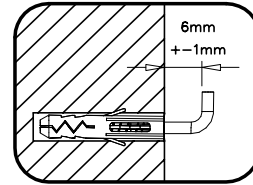

5

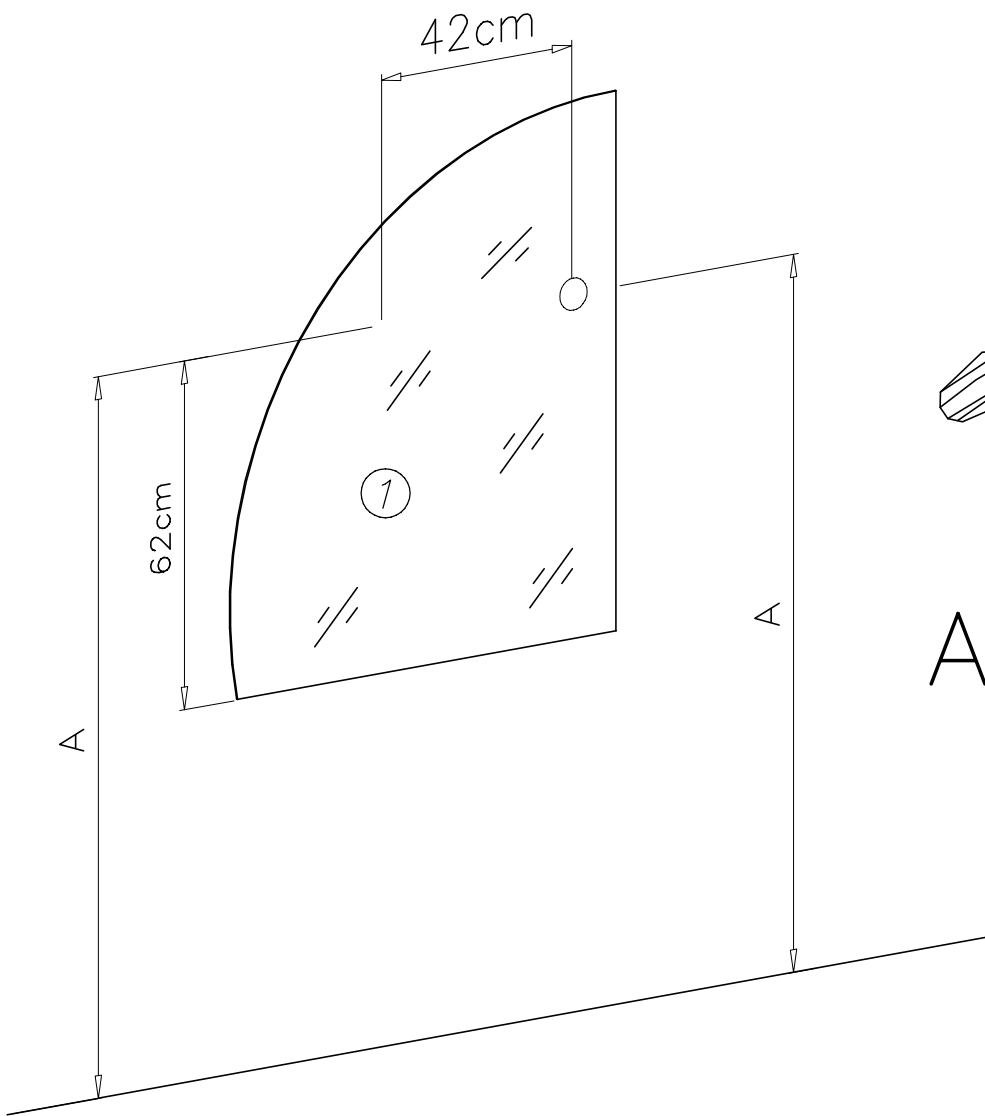
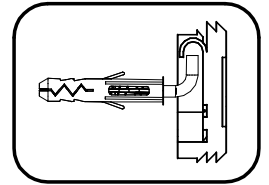

A = A

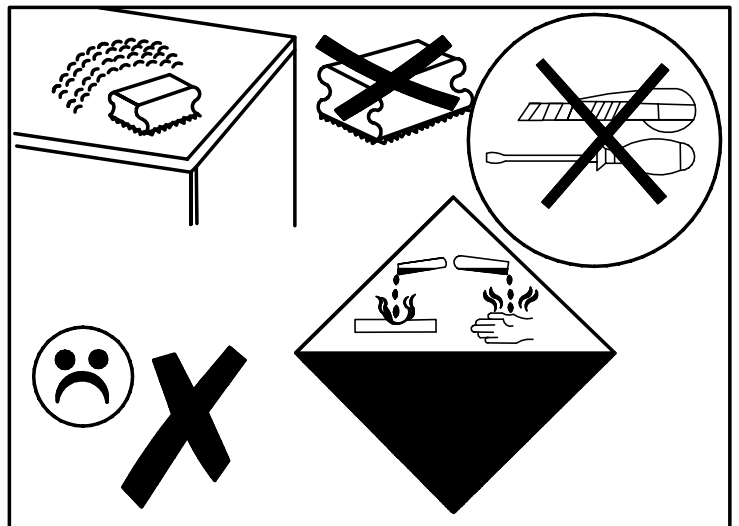
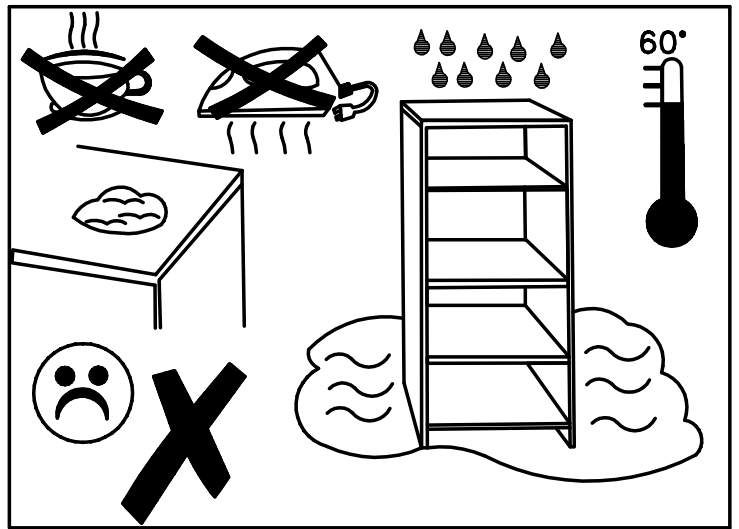
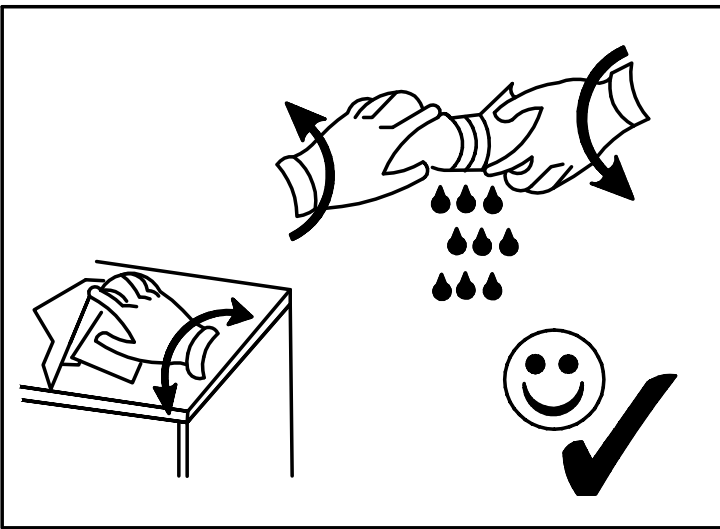
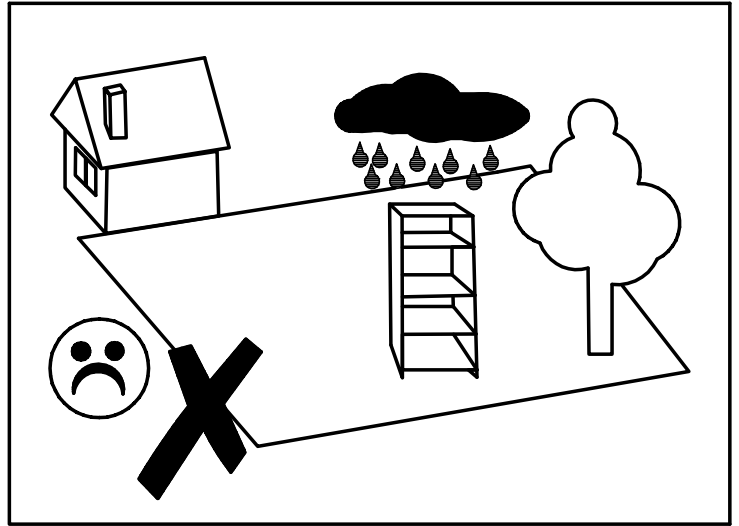
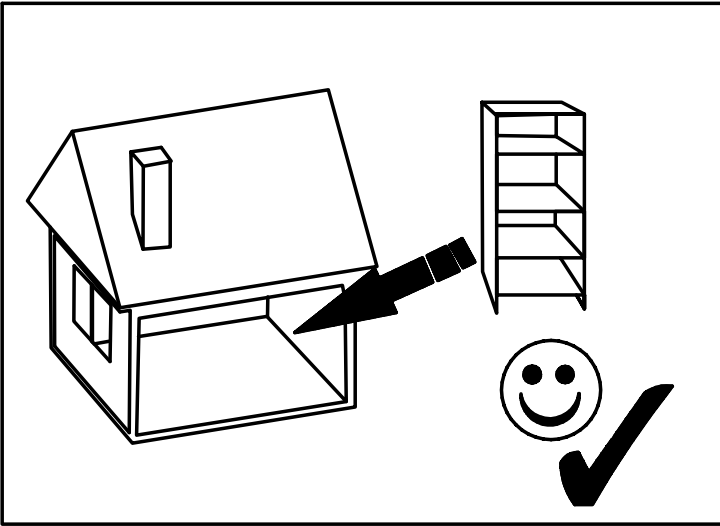



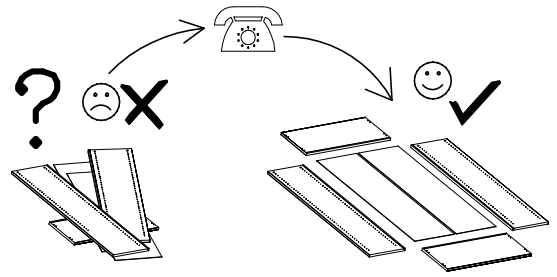
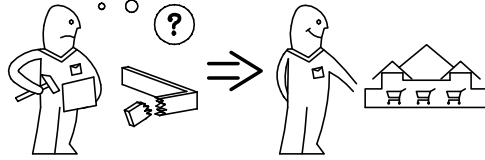
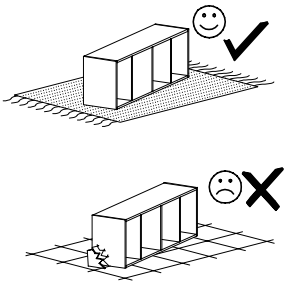

nr	L[mm]	B[mm]	T[mm]	Menge	Colli
1	920	770	19	1	1/2

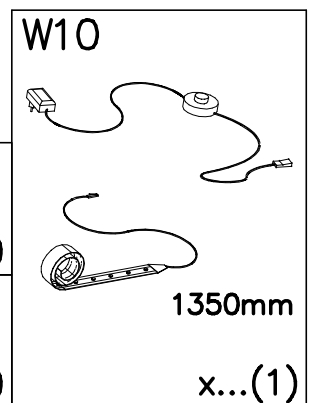
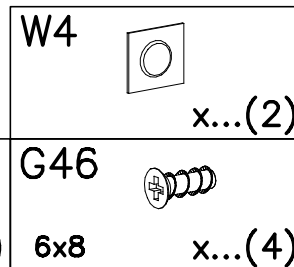
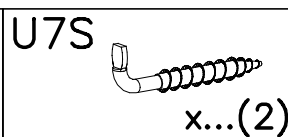
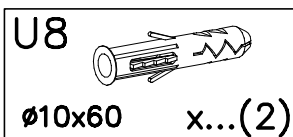
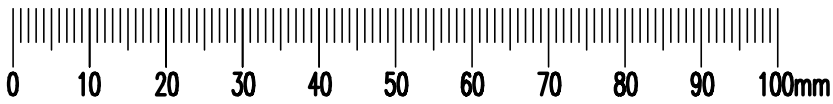
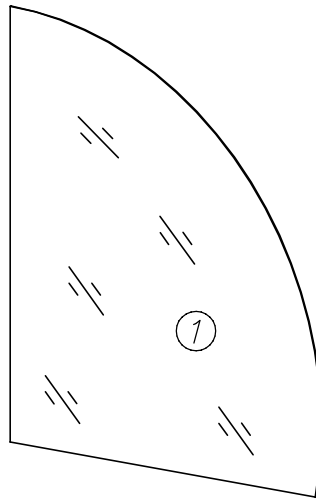



I



G46



6x8

x...(4)

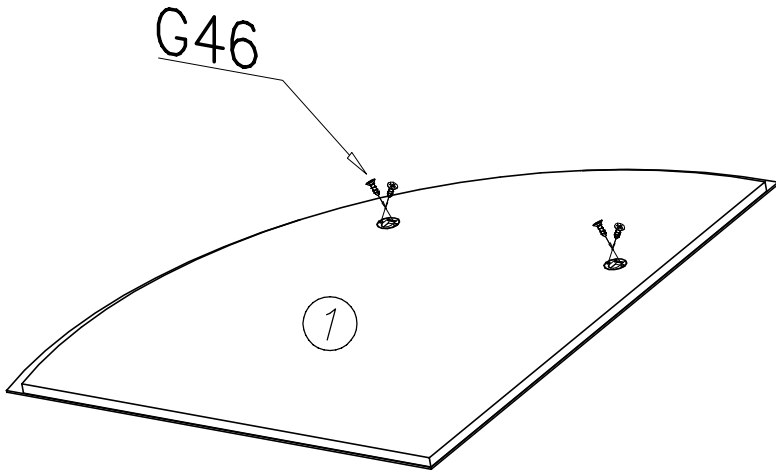
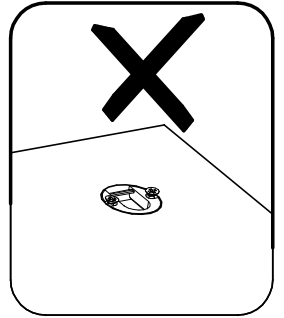
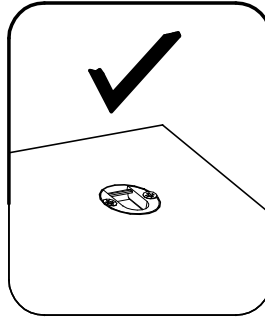
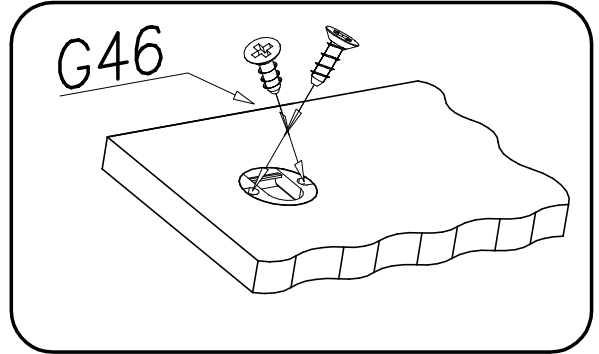

II

W4



2x

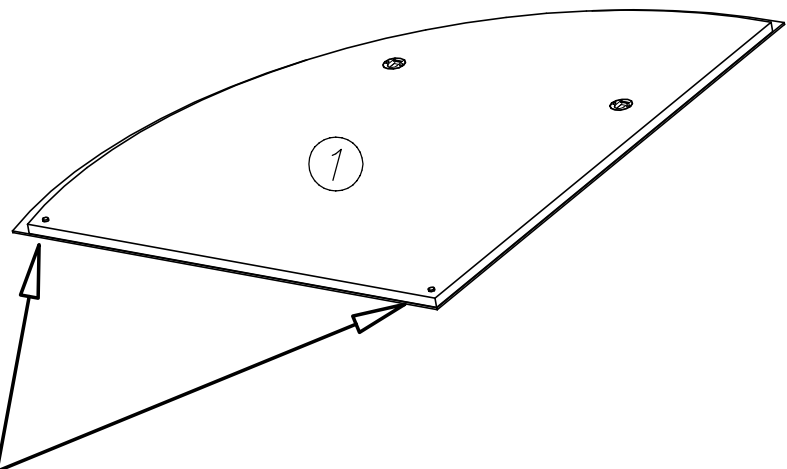
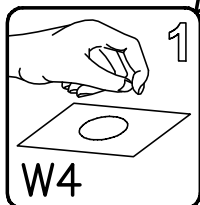
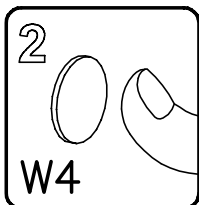



III

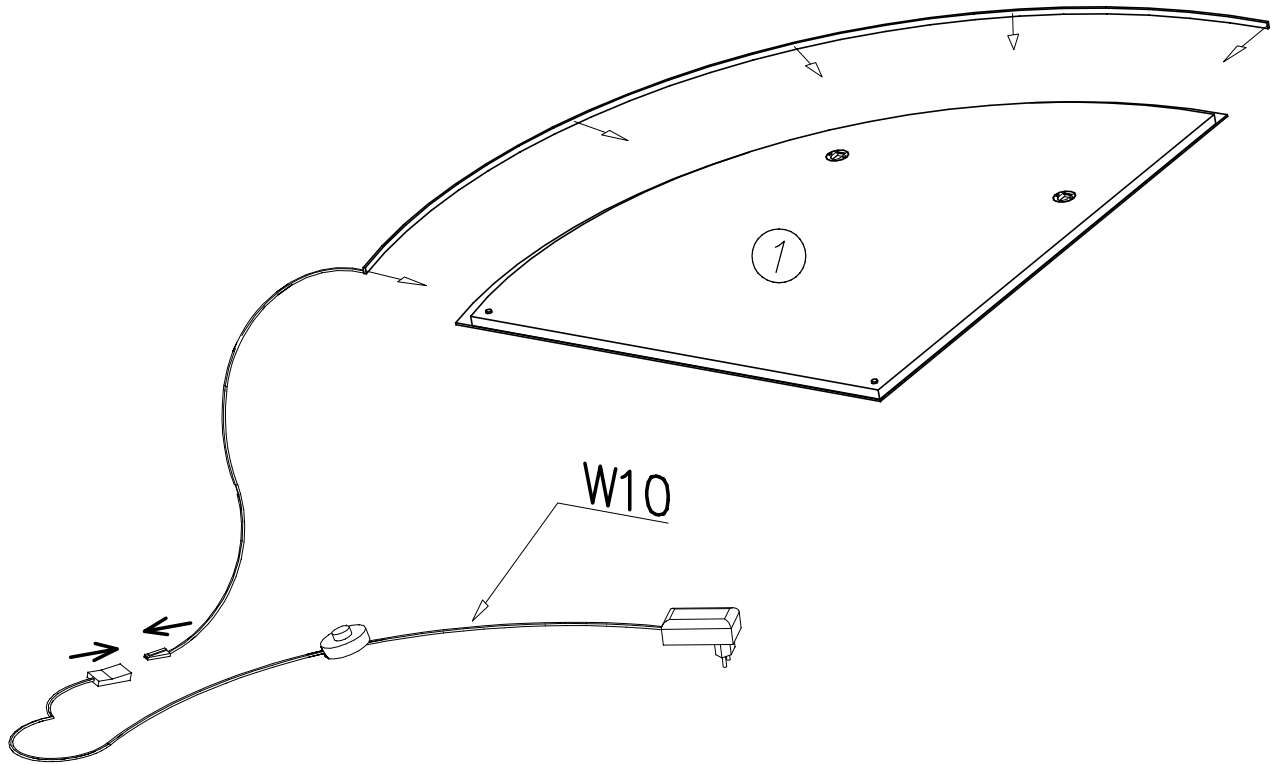
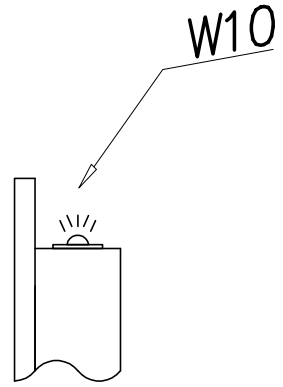
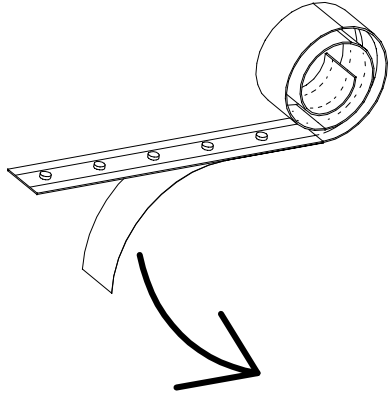



# IV

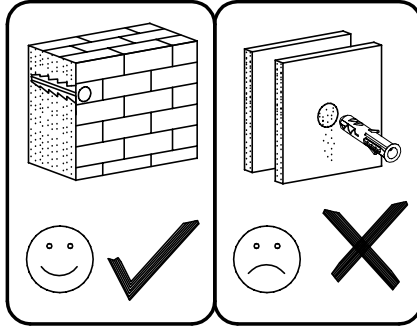

1

2

3

4

5

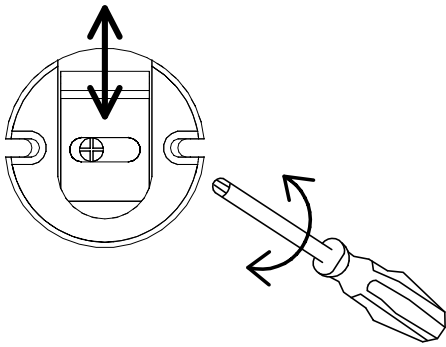
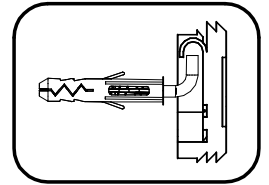
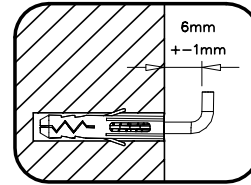
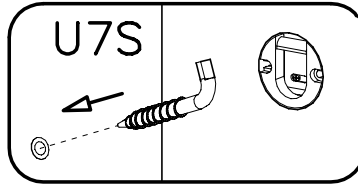
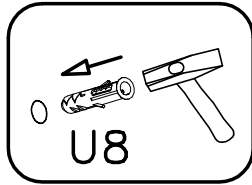
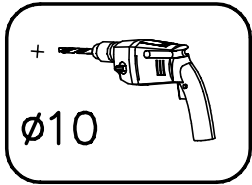

A = A

