







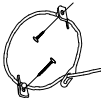

ASSEMBLY INSTRUCTION

BOX OF CHEST CHEST

ITEM	DRAWING	DESCRIPTION	QTY
A		CHEST	1
B		LEG (B) (Located in the bottom drawer)	2
C		LEG (C) (Located in the bottom drawer)	2
D		TIPPING RESTRAINT (Affix to wall behind dresser) *Located in the right side front drawer	1

BOX OF CHEST HARDWARE LIST

ITEM	DRAWING	DESCRIPTION	QTY
1		WOOD DOWEL M8x30mm	4
2		JCBC SCREW M6x40mm	4
3		SPRING WASHER	4
4		FLAT WASHER	4
5		L-KEY M4x65mm	1

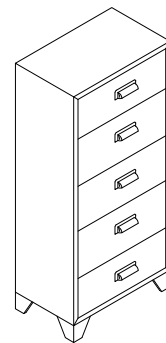

COMPLETED CHEST ASSEMBLY

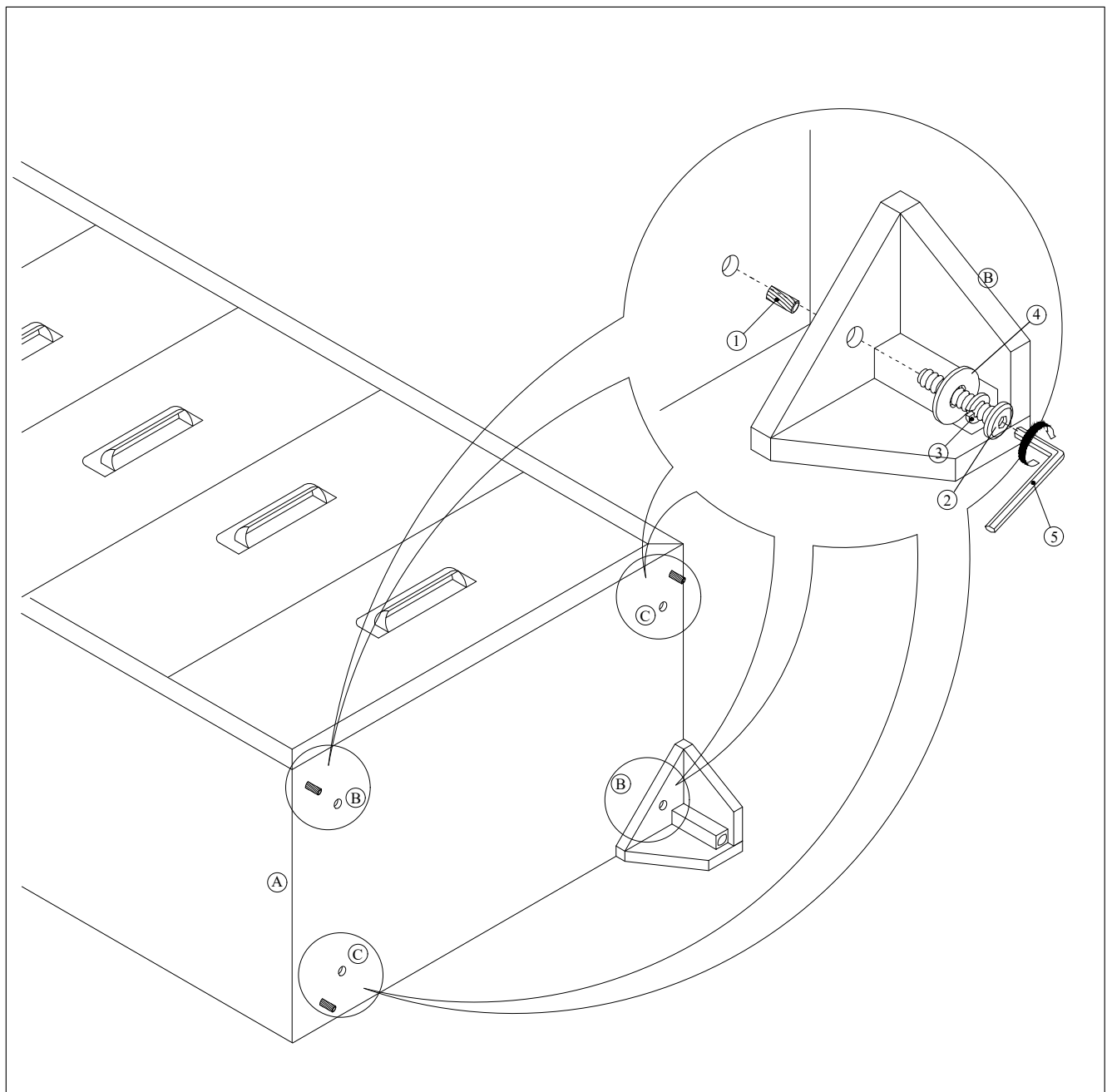

THE HARDWARE IS LOCATED IN THE PACKING ITEMS
THE ANTI TIPPING HARDWARE IS LOCATED IN THE CHEST 1ST DRAWER

NOTE : MUST TIGHT SCREWS PERIODICALL. WITH USE SCREWS MAY BECOME LOOSE.
CHECK TIGHNESS OF ALL SCREWS EVERY 6-8 WEEKS.