

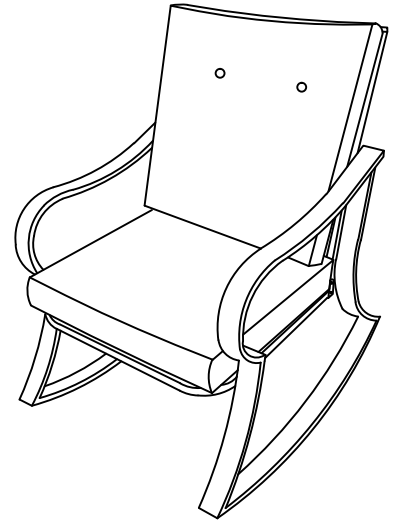

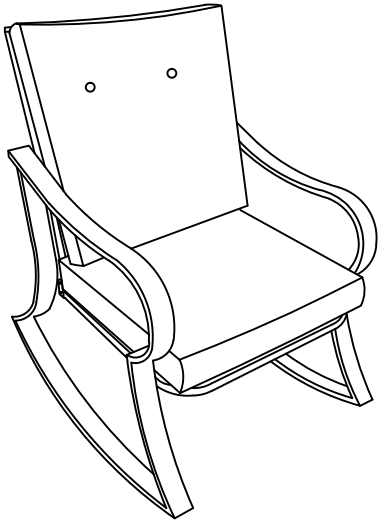











# 3-Piece Rocking Bistro Set

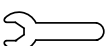

## 3-Piece Rocking Bistro Set Coffee Table

Item no.	Reference Image	Description	Qty.
A		Left Arm Rest	2
B		Right Arm Rest	2
C		Seat Back & Base	2
D		Table Top	1
E		Leg Brace	1
F		Table Leg	4
G		M6 x 36 Socket Head Cap Screw	16
H		M6 x 28 Socket Head Cap Screw	4
I		Washer	20
J		Nut	8
K		Screw	4
L		Allen Key	1
M		Wrench	1
N		Back Cushion	2
O		Base Cushion	2

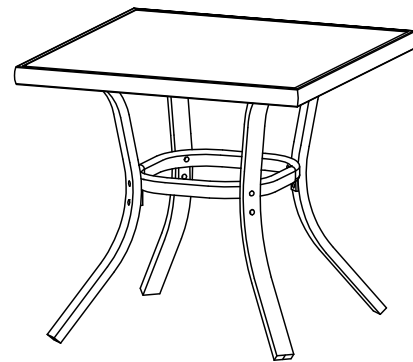

### Tips:

Do not tighten screws fully until the item is fully assembled.

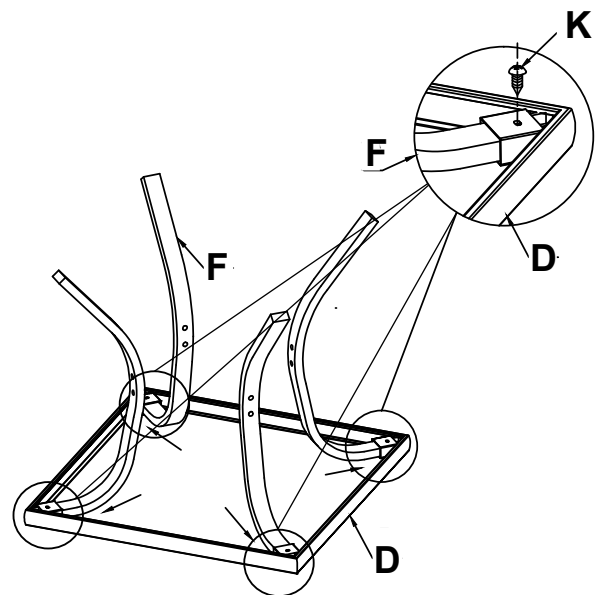

**1**

Flip table top (D) upside down. Attach table leg (F) to table top (D) using screw (K). Do this in four places.

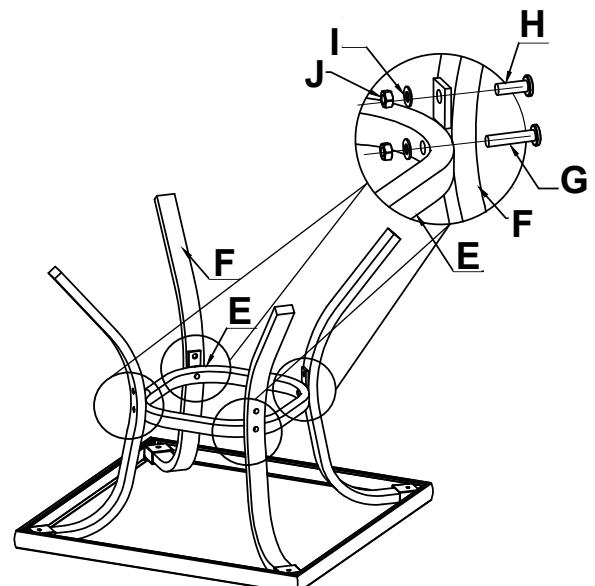

**2**

Attach the leg brace (E) to each table leg (F) using a M6 x 28 socket head cap screw (H) and M6 x 36 socket head cap screw (G) with a washer (I) and a nut (J). Do this in four places.

## 3-Piece Rocking Bistro Set Coffee Table



**3**

Flip the assembly upright. Check assembly alignment and tighten all screws.

Tips: Do not tighten screws fully until the item is fully assembled.

## 3-Piece Rocking Bistro Set

### Rocking Chair - DO THIS TWICE

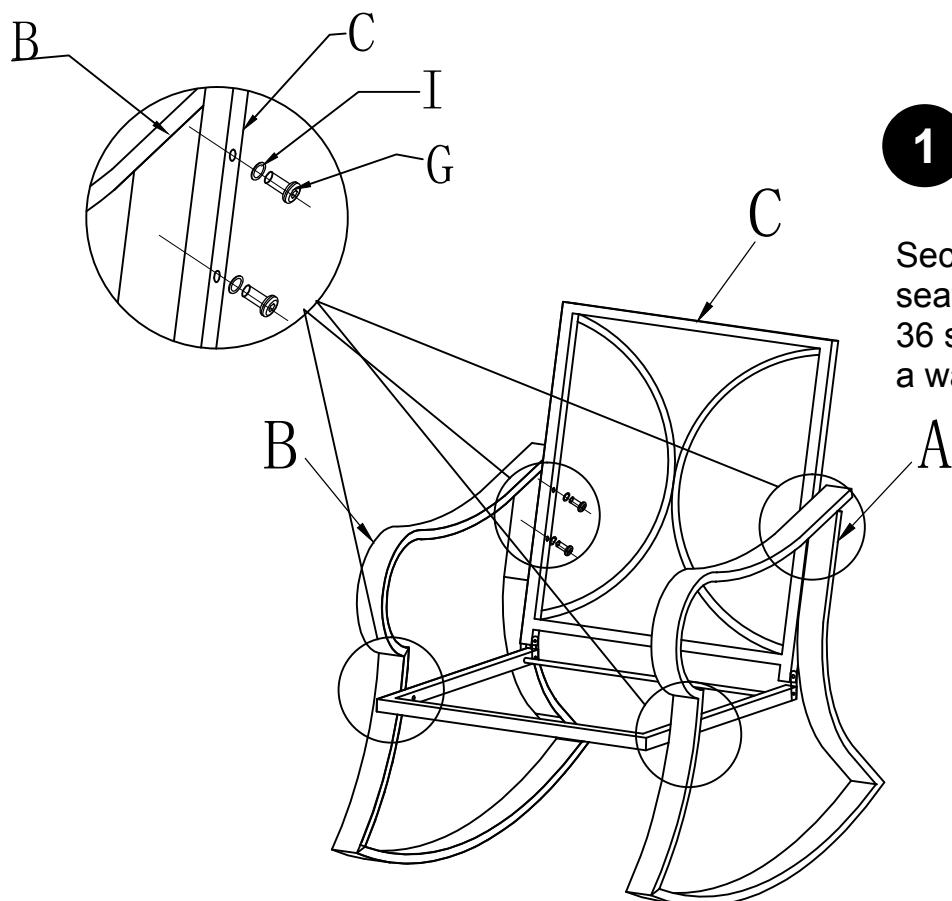

1

Secure the arm rests (A & B) to the seat back and base (C) using M6 x 36 socket head cap screw (G) with a washer (I). Do this in six places.

2

Check assembly alignment and tighten all screws. Place the back (N) and base (O) cushions on the chair.

Tips: Do not tighten screws fully until the item is fully assembled.

