

2 Place Seat Cushion (D) and Back Cushion (E) on assembled Armless Chair Frame.

Model: _____
Lot No: _____
Date of Purchase: _____

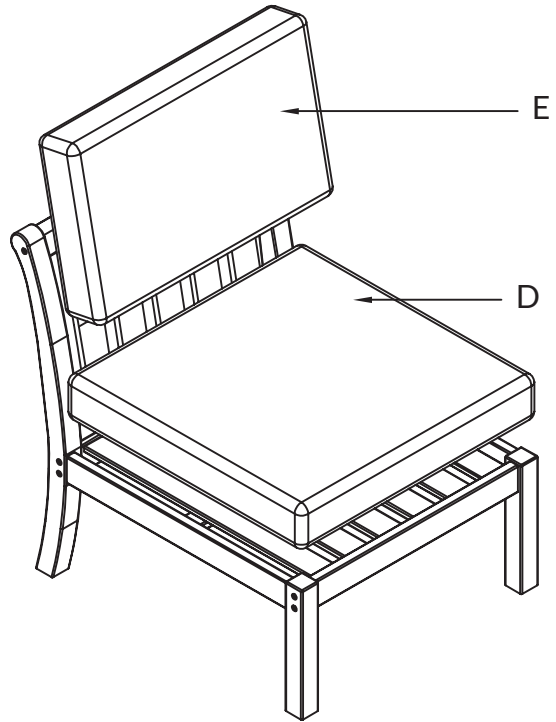

ARMLESS CHAIR

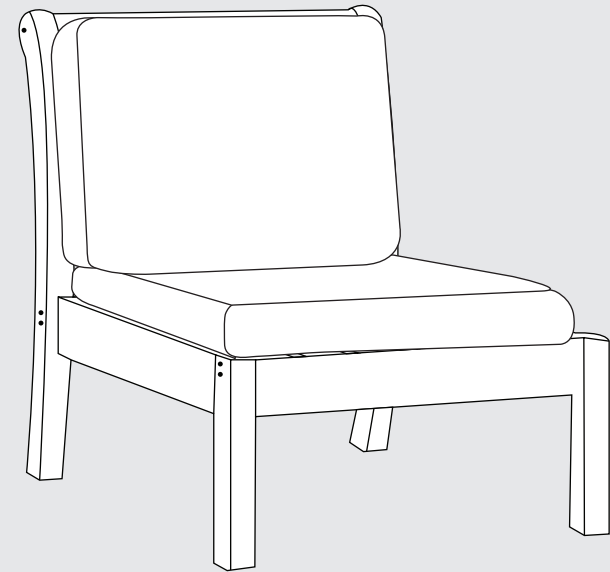

ADULT ASSEMBLY REQUIRED

If you are missing any parts or have any questions regarding assembly, do not return this item to the retailers store. Please call our toll-free, customer service number and have this assembly manual open to the parts list ready to provide the model name, number and part name or number.



WARNING: This product may contain small components, please ensure they are kept away from small children.

PARTS AND HARDWARE

Avoid using sharp objects such as a knife to cut open packing as you may accidentally damage the upholstery.

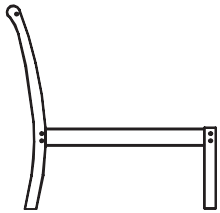

A. Left Leg
1x

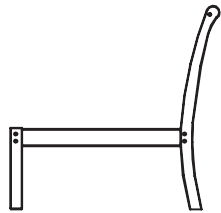

B. Right Leg
1x

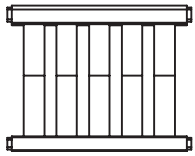

C. Back Rest
1x

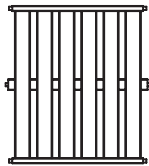

D. Seat Deck
1x

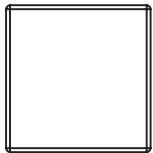

E. Seat Cushion
1x



F. Back Cushion
1x



G. Bolt
10x



H. Allen Key
1x

ASSEMBLY INSTRUCTIONS

Do not fully tighten bolts until assembly is complete.

- 1 Attach Left Armless Frame (A) and Right Armless Frame (B) to Back Rest (C) and Seat Deck (D) using Bolts (G). Tighten using provided Allen Key (H).

