

ASSEMBLY INSTRUCTION

DINING CHAIR

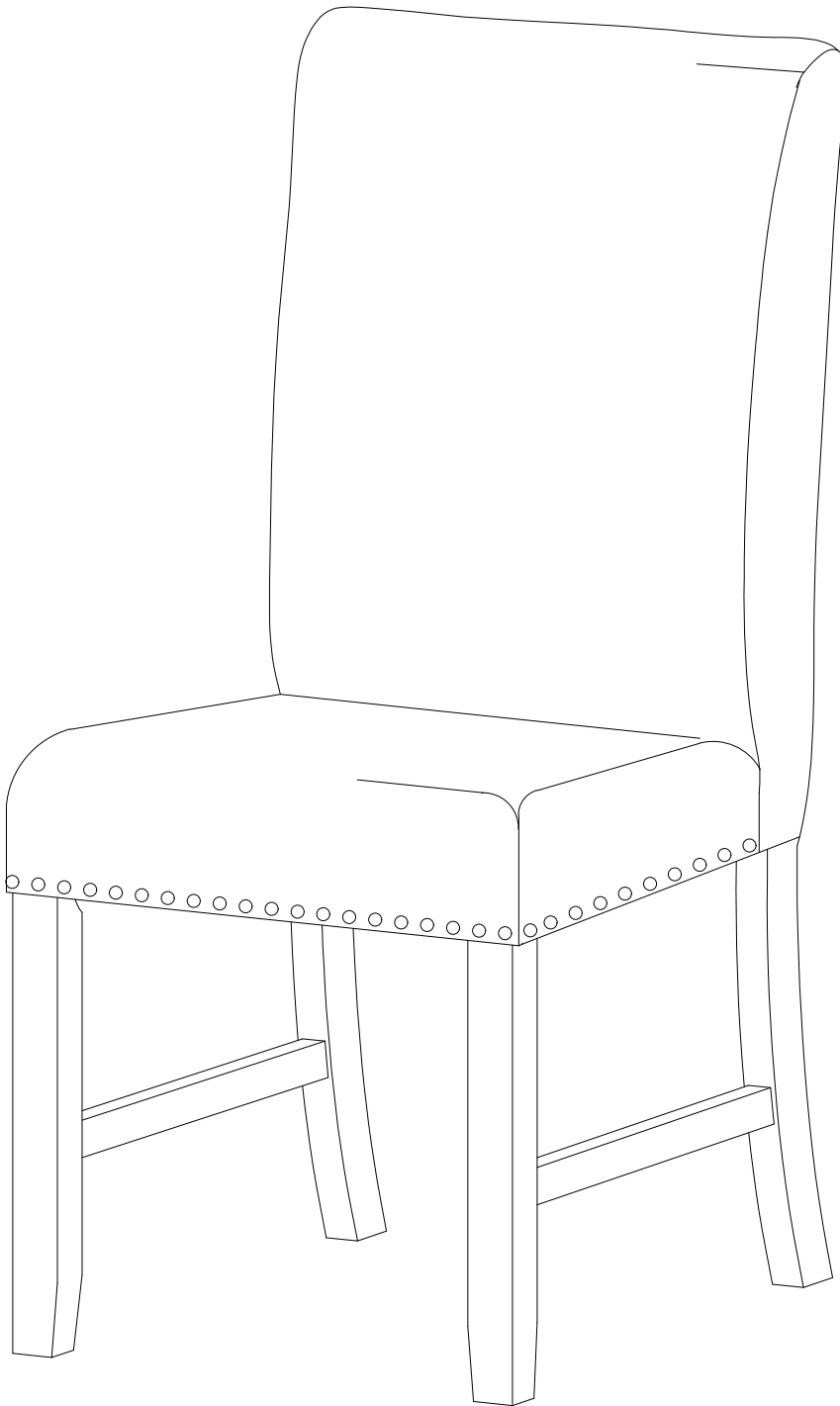

Please read these instructions fully before starting assembly:

1. Place all wooden parts on a clean and smooth surface such as a rug or carpet to avoid scratching the parts.
2. Kindly follow the assembly instructions step by step.
3. Do not tighten all screws and bolts until the chair is fully assembled.
4. Unscrew the protective plastic supports from the metal insert of the legs before assembly.
5. Parts of the assembly will be easier with 2 people.

Care and maintenance:





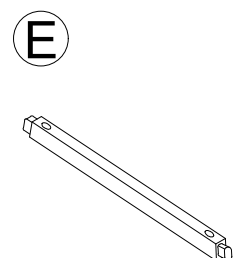
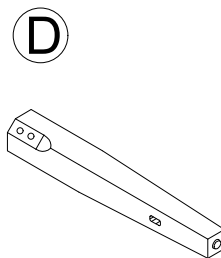
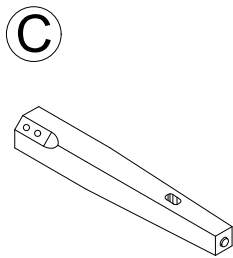
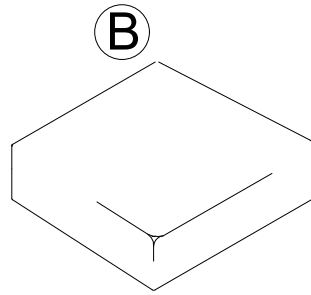
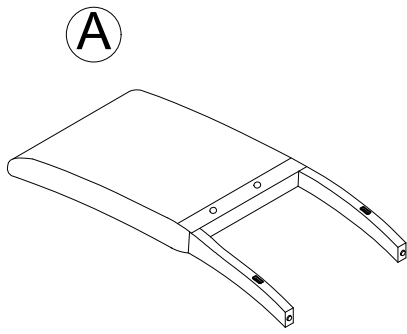





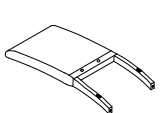

Only clean using a damp cloth and mild detergent, do not use bleach or abrasive cleaners.

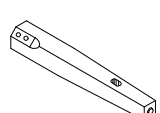
ASSEMBLY INSTRUCTION

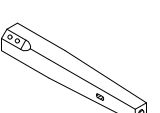

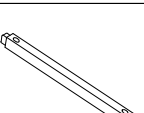
Part List For One





Hardware List For One

A		CHAIR BACK (1PC)	1	 Ø1/4"x80mm	LONG BOLT (4PCS)
B		SEAT CUSHION (1PC)	2	 Ø1/4"x60mm	BOLT (4PCS)
C		LEFT LEG (1PC)	3	 Ø1/4"x38mm	BOLT (2PCS)
D		RIGHT LEG (1PC)	4	 Ø1/4"x11mm	SPRING WASHER (10PCS)
E		SIDE STRECHER (2PCS)	5	 Ø1/4"x19mm	FLAT WASHER (10PCS)
			6	 M4	ALLEN KEY (1PCS)
			7	 #8 x 38mm	WOOD SCREW (4PCS)

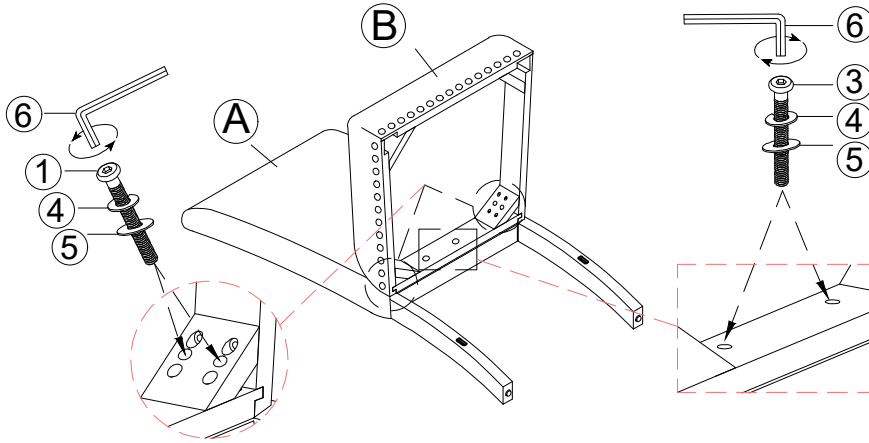
ASSEMBLY INSTRUCTION

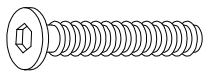

STEP 1

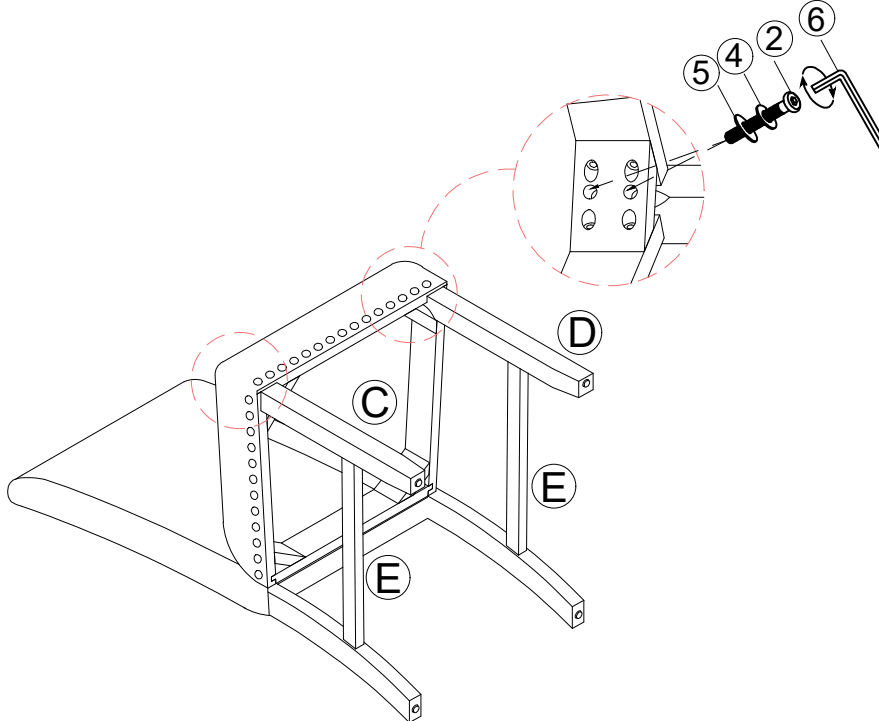

1  Ø1/4"x80mm	LONG BOLT (4PCS)	3  Ø1/4"x38mm	BOLT (2PCS)
4  Ø1/4"x11mm	SPRING WASHER (6PCS)	5  Ø1/4"x19mm	FLAT WASHER (6PCS)
6  M4	ALLEN KEY (1PC)		

STEP 2

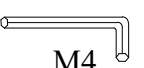

2  Ø1/4"x60mm	BOLT (4PCS)	4  Ø1/4"x11mm	SPRING WASHER (4PCS)
5  Ø1/4"x19mm	FLAT WASHER (4PCS)	6  M4	ALLEN KEY (1PC)

ASSEMBLY INSTRUCTION

STEP 3

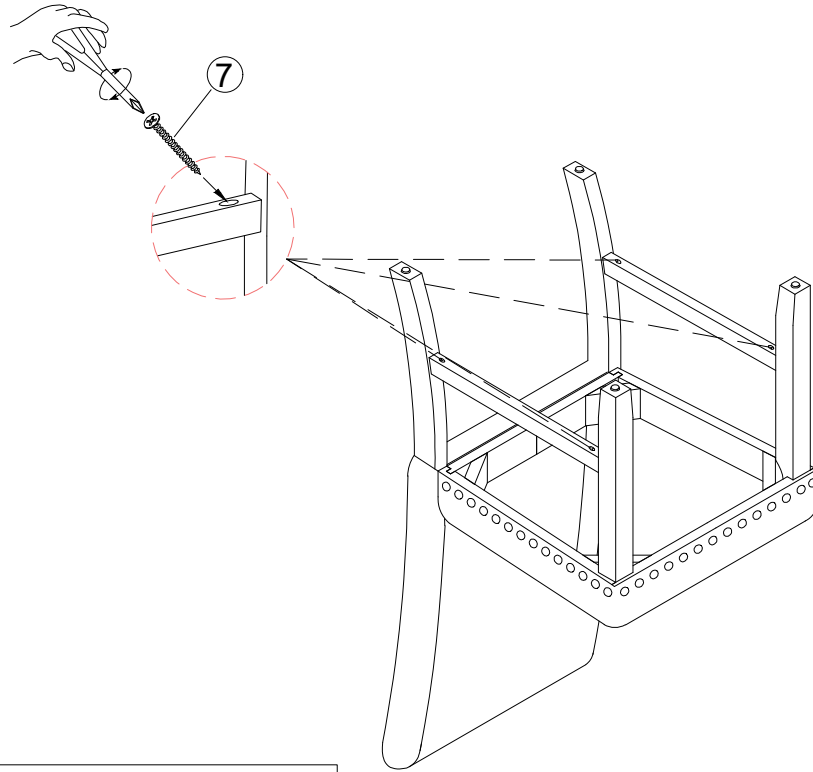

7		WOOD SCREW (4PCS)
	#8 x 38mm	

COMPLETE

