

Double-Seat Rocking Egg Chair

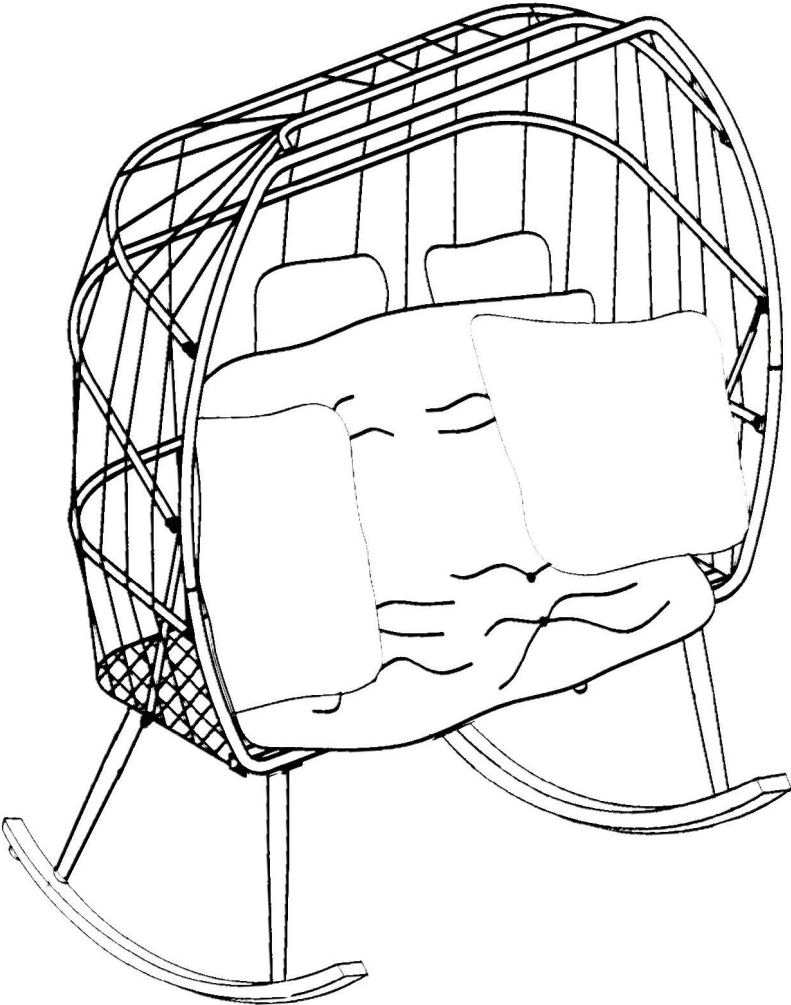







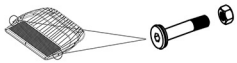
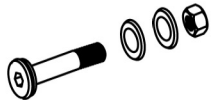

① Assembly Tips

1. Lay everything out before you begin

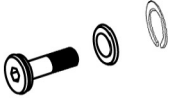
Getting familiar with all the components before assembly will make for a faster and easier assembly process.

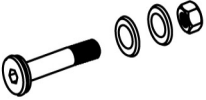
2. Assemble on a soft surface

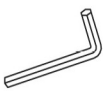
We recommend assembling your egg chair on a soft surface such as a rug.



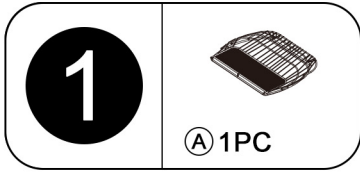

Part No.	Reference Image	Qty.	Part No.	Reference Image	Qty.
A	<p>Screws have installed in the "A"</p>  <p>M6X35 self-Hold Nut x2</p>	X1	F	 <p>M6X22mm self-Hold Nut</p>	X2
B		X1	G	 <p>M6X15</p>	X10
C		X1	J	 <p>M6X28mm self-Hold Nut</p>	X2
D		X1	K	 <p>M6</p>	X1
E		X2	L	 <p>M6</p>	X1



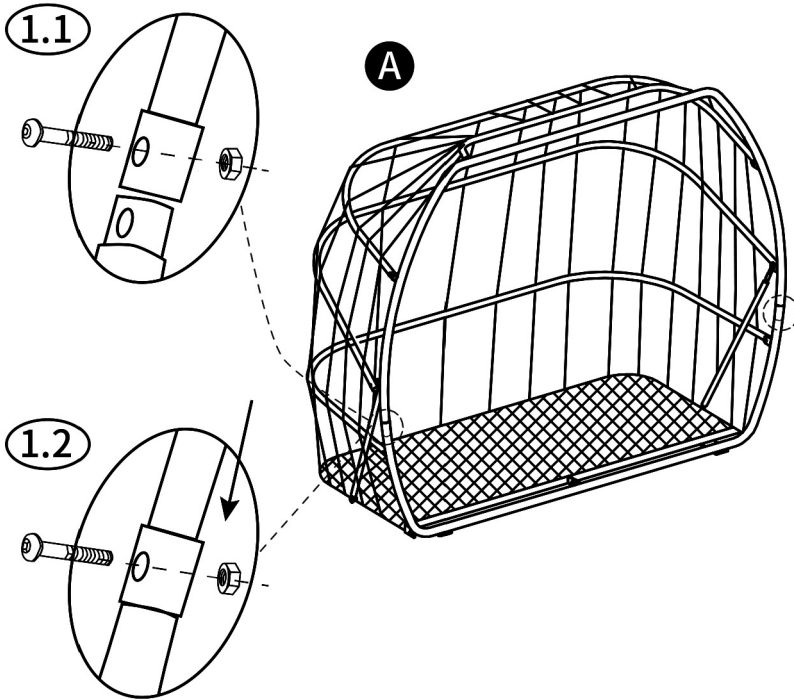



1.1. Remove the screw, what originally installed on the "A".

1.2. Align it with the hole position, and then install and tighten the screw again.

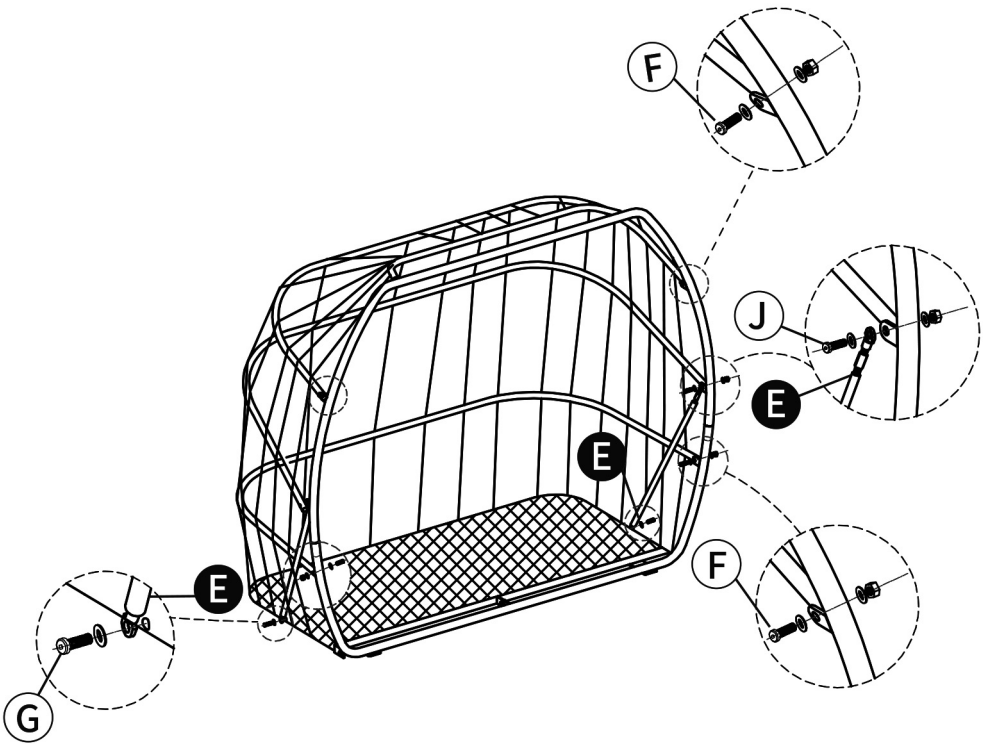

2				
	(E) 2PC	(F) 4PC M6x22	(G) 2PC M6x15	(J) 2PC M6x28



3				
	(A) 1PC	(C) 1PC	(D) 1PC	M6x15 (G) 8PC

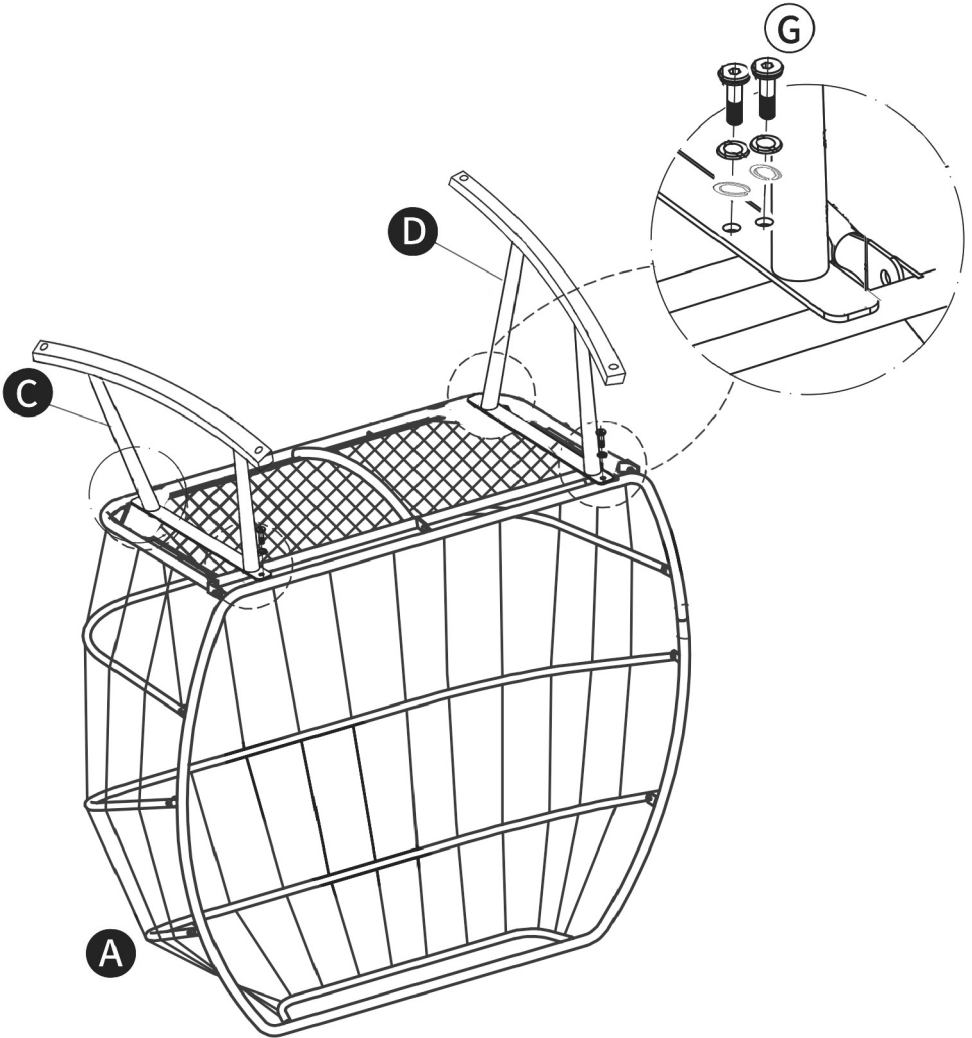

4	 Ⓑ 1PC
----------	--

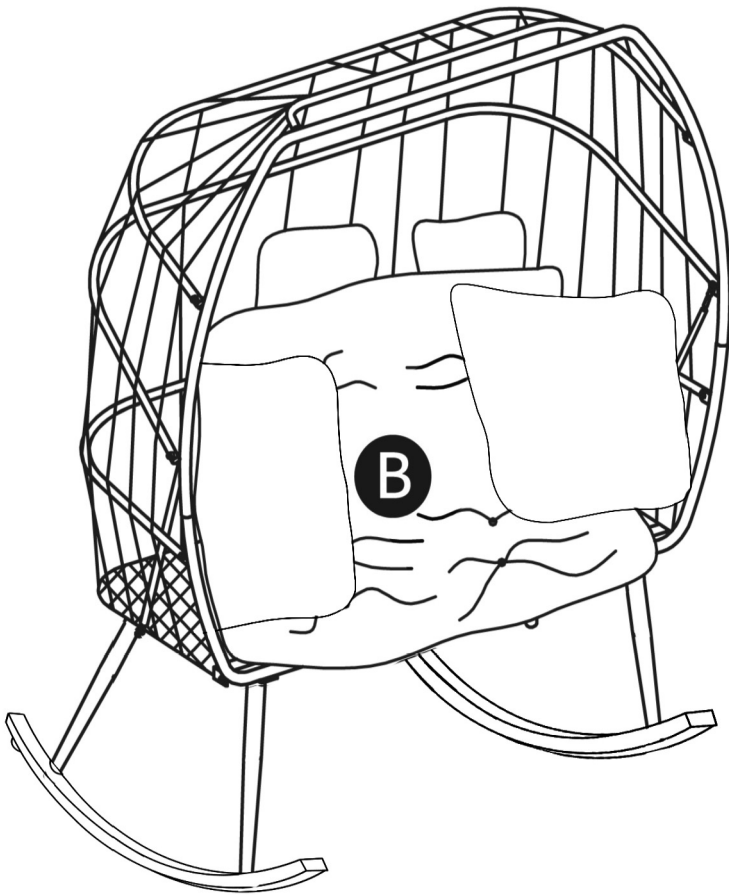

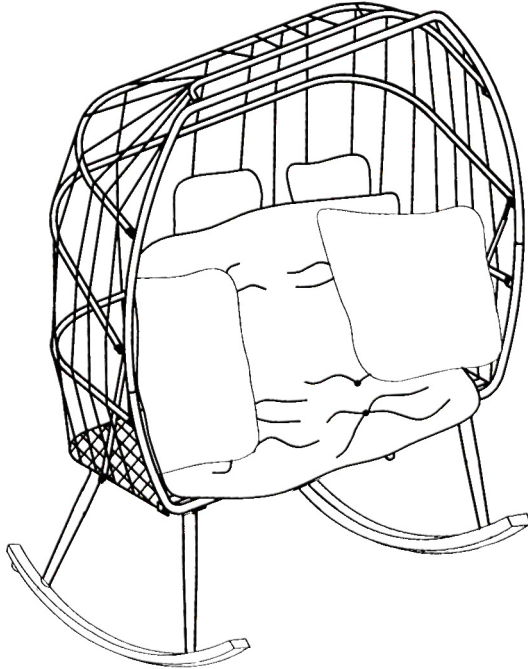

If you have any questions, feel free to contact us.
