

**INSTALLATION INSTRUCTIONS FOR BATHTUB SHOWER DOOR  
INSTRUCTIONS D'INSTALLATION DE PORTE DE BAINOIRE**

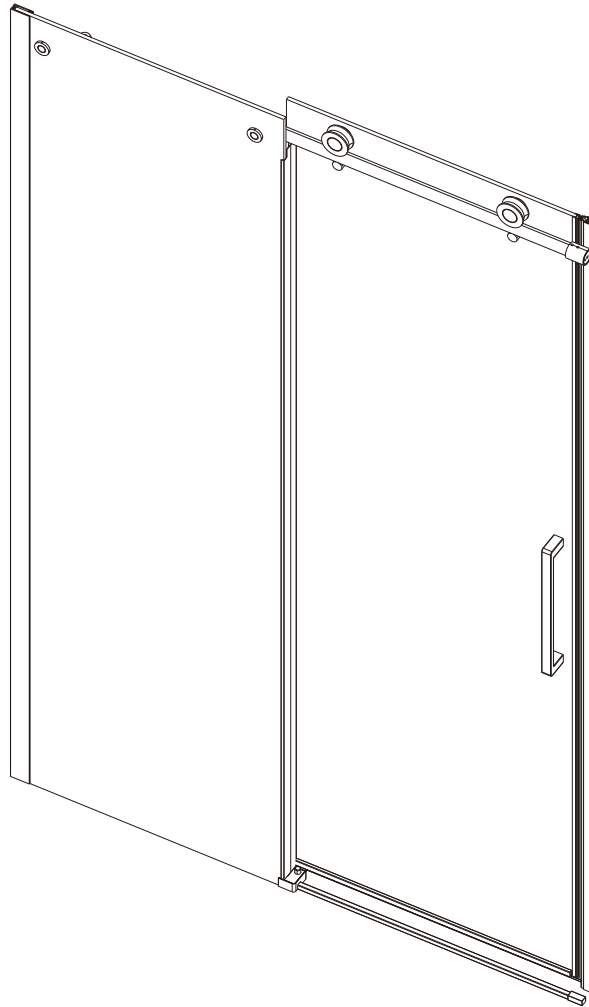

READ ALL INSTRUCTIONS CAREFULLY BEFORE PROCEEDING  
**LIRE TOUTES LES INSTRUCTIONS ATTENTIVEMENT AVANT COMMENCER L'INSTALLATION**

---

SAVE THIS GUIDE FOR FUTURE REFERENCE  
**CONSERVER POUR UN USAGE ULTÉRIEUR**

Introduction	2
<b>Introduction</b>	
Table of contents	2
<b>Table des matières</b>	
Parts and components	3-4
<b>Pièces et composants</b>	
Shower door installation	5-10
<b>Installation de la porte de douche</b>	

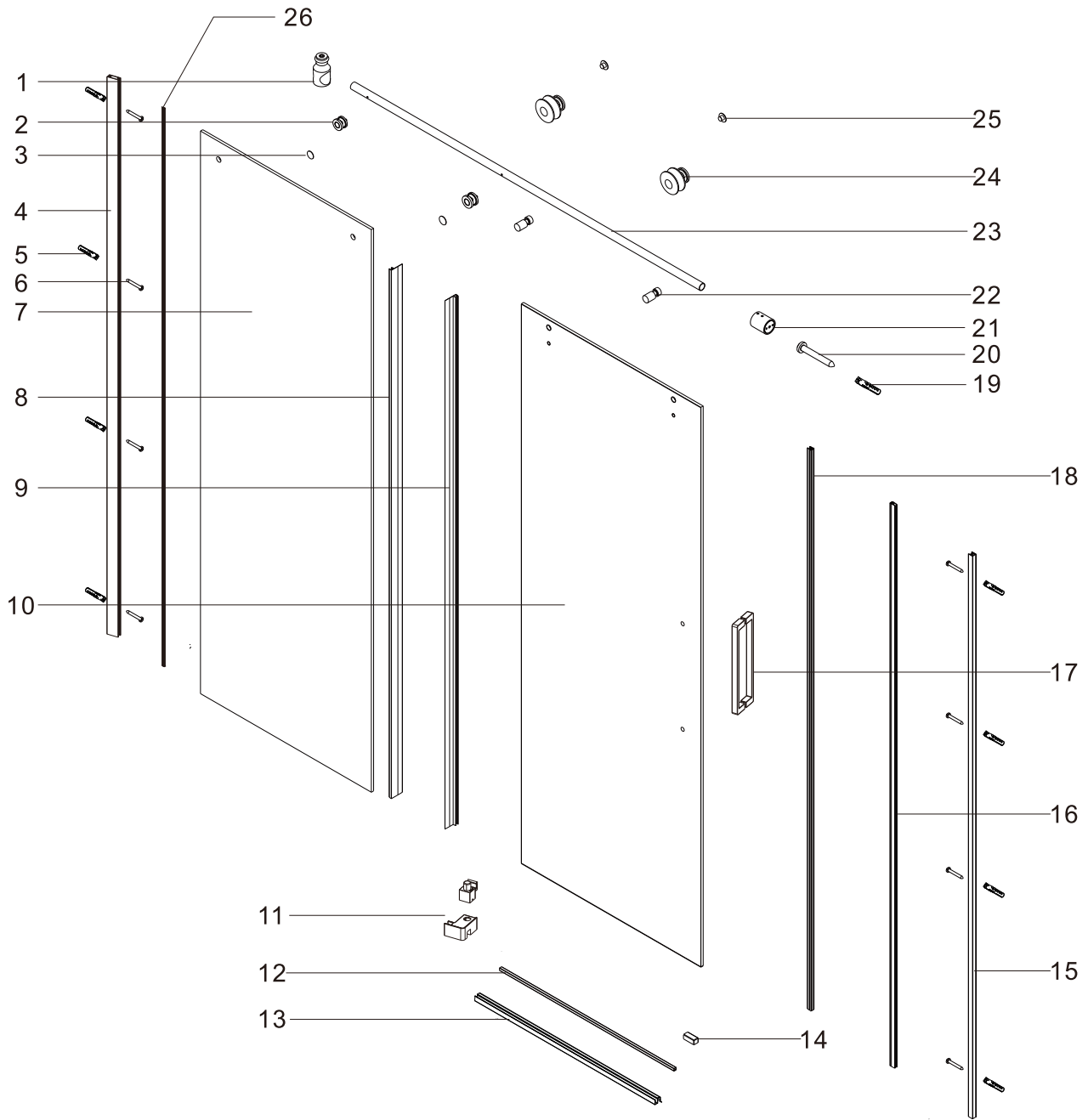
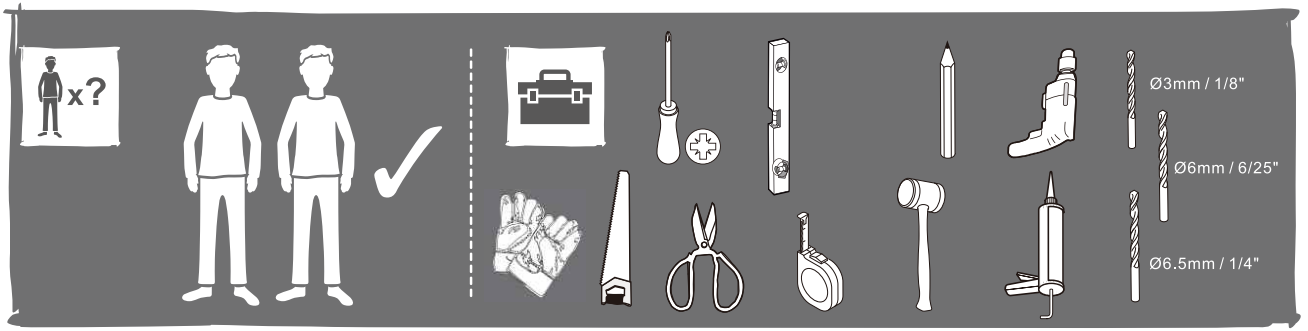

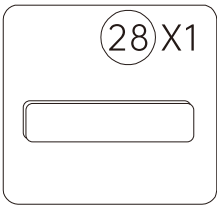
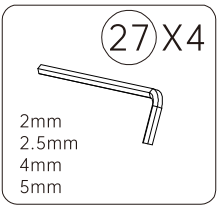
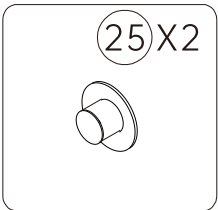
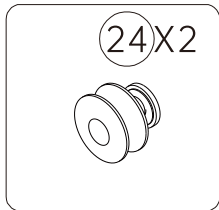
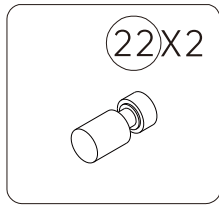
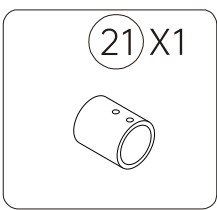
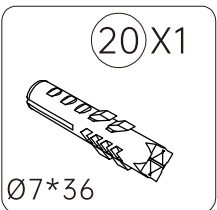
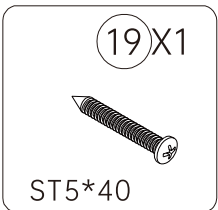
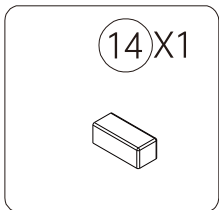
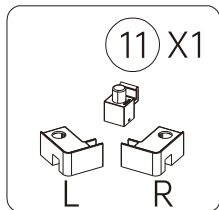
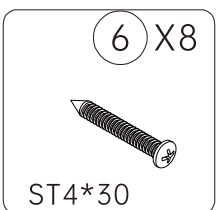
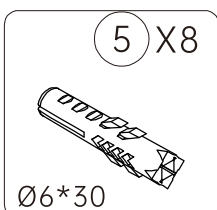
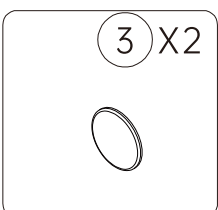
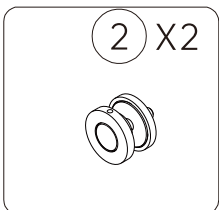
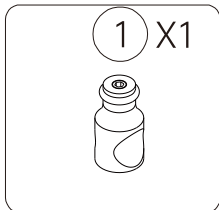
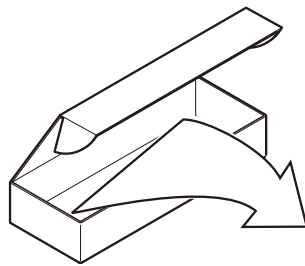
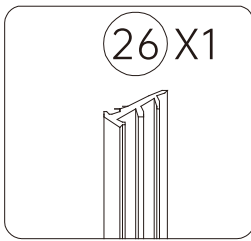
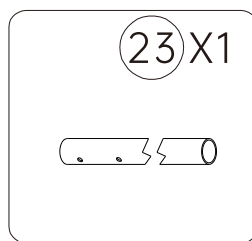
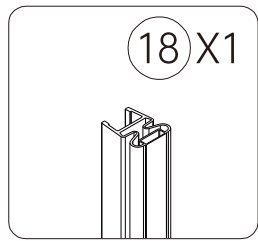
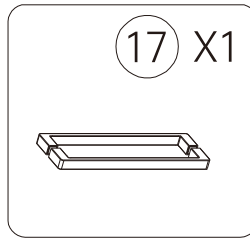
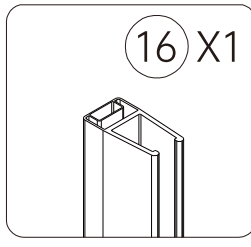
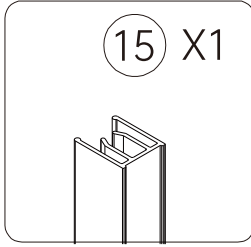
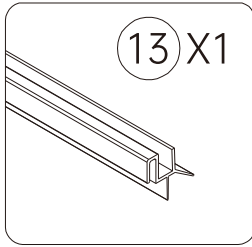
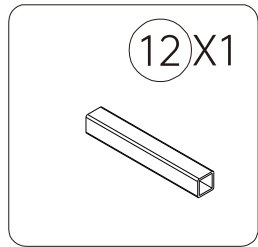
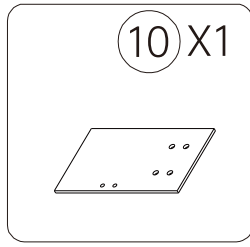
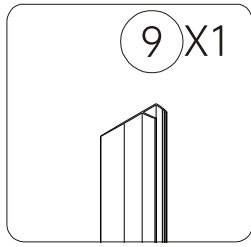
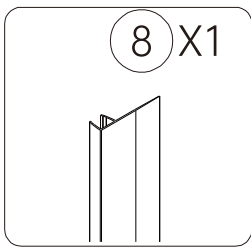
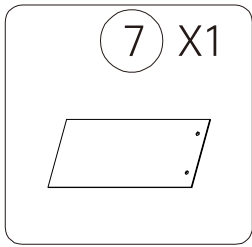
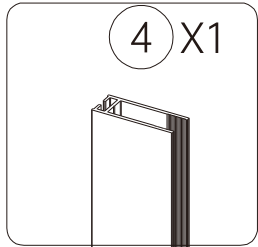

01

4 X1



5 X8



Ø6\*30

6 X8



ST4\*30

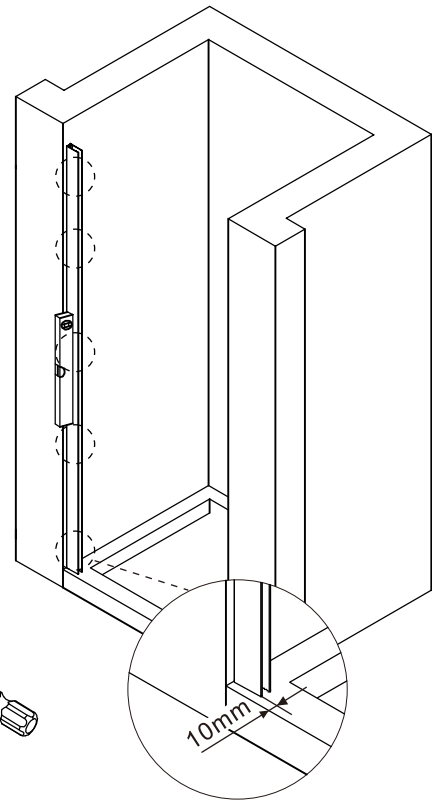
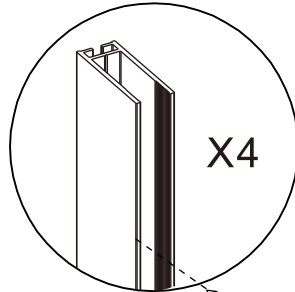
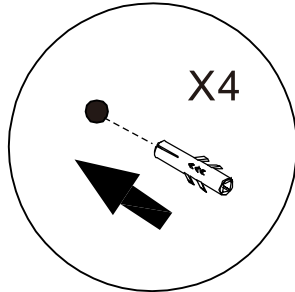
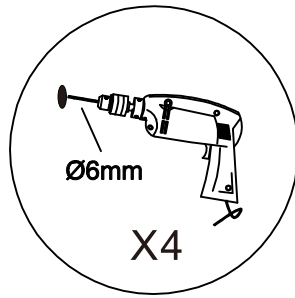
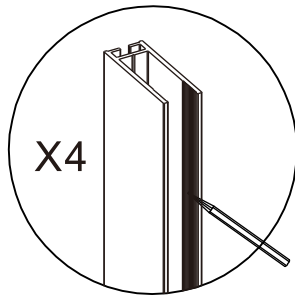

02

7 X1

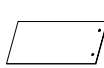

26 X1



28 X1

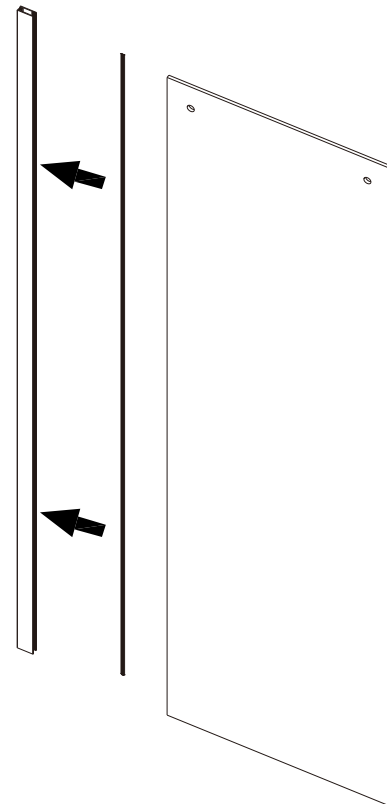
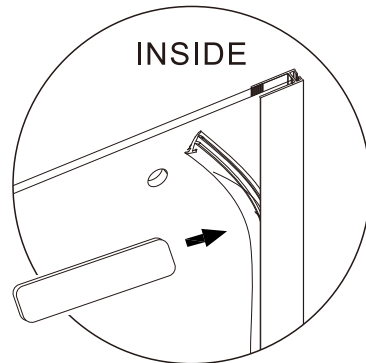
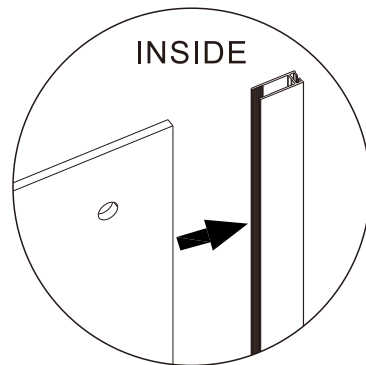

03

23 X1

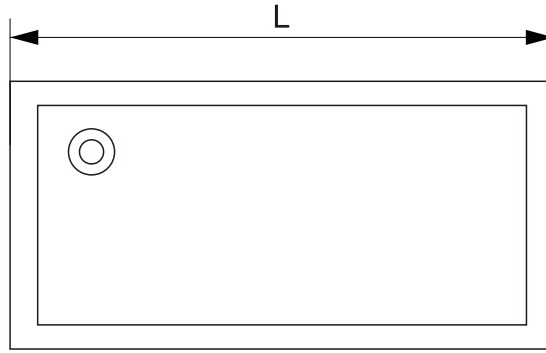
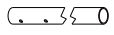

if :  $L \leq 1524\text{mm}$   
 $L1 = L - 24\text{mm}$

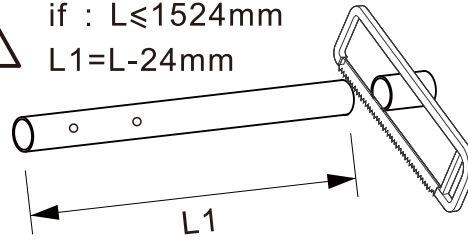

Do not cut near the drilling side, should cut on the other non-drilling side

04

1 X1



2 X2



21 X1

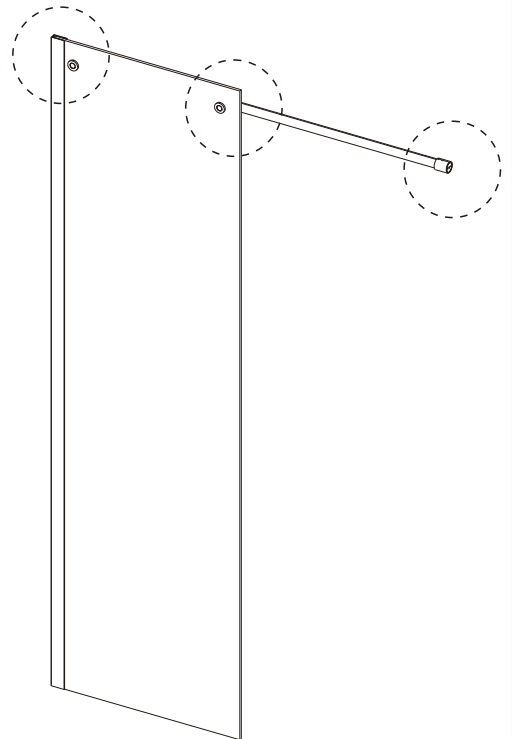
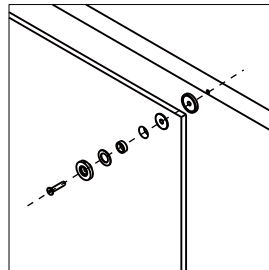
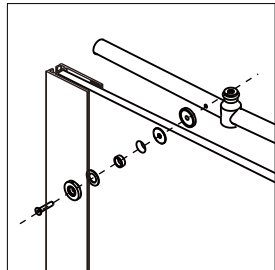
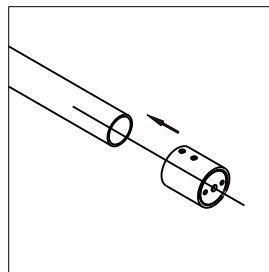
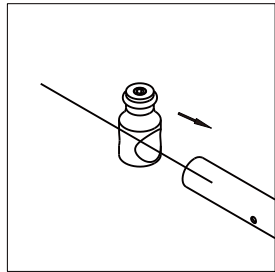

# 05

(11) X1

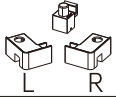

(19) X1



(20) X1



(27) X4

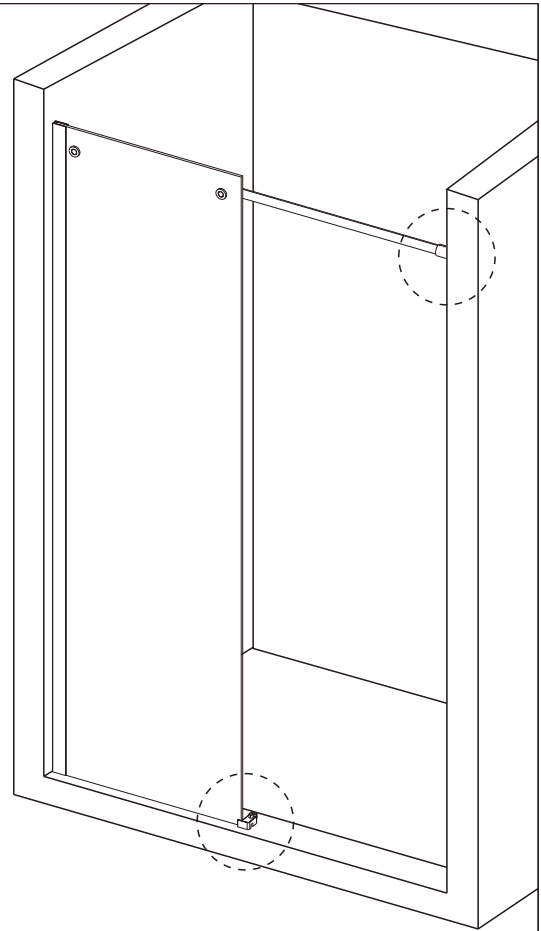
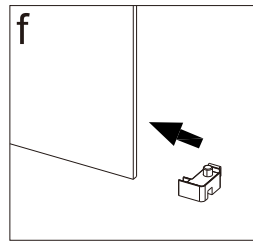
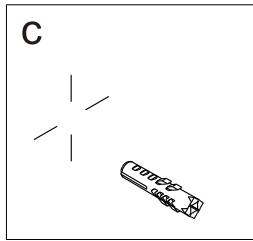
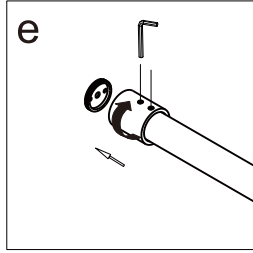
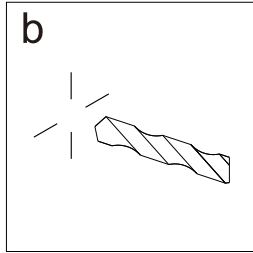
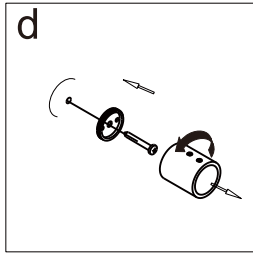
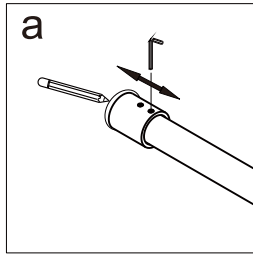
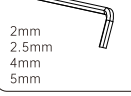

# 06

(10) X1

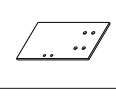

(13) X1

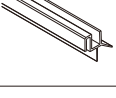

(18) X1

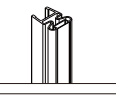

(17) X1

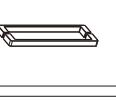

(24) X2

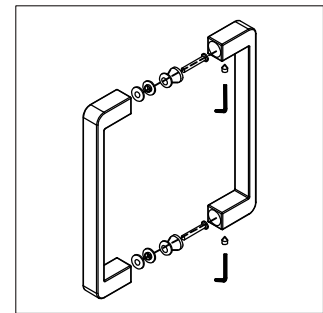
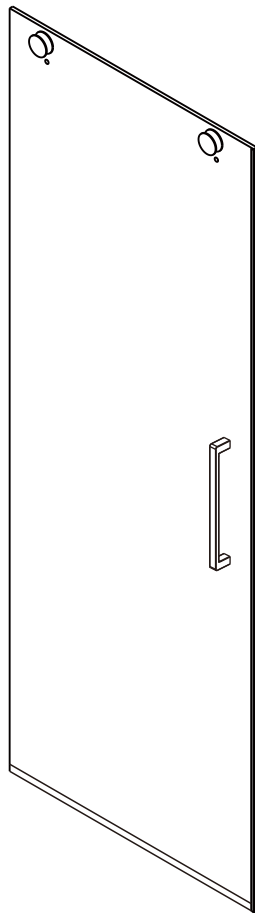
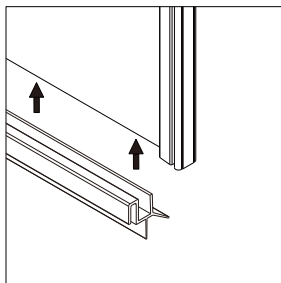
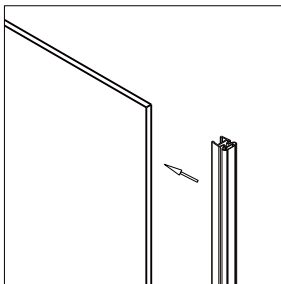
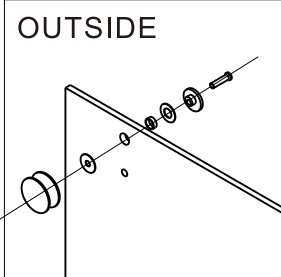
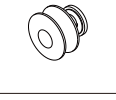

# 07

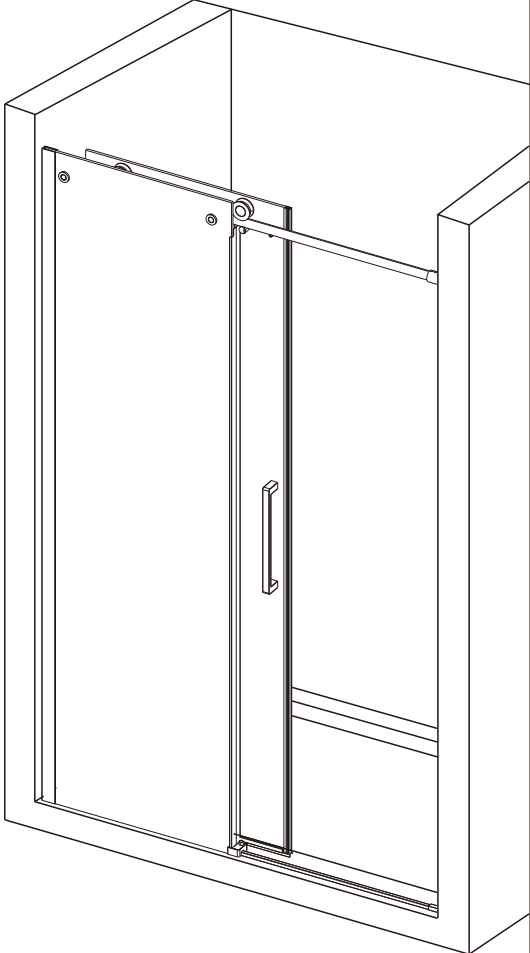
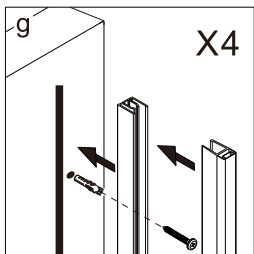
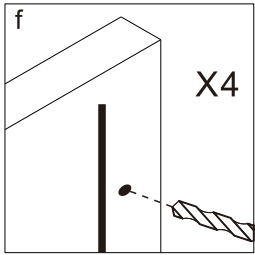
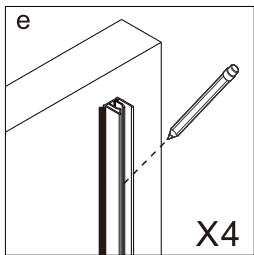
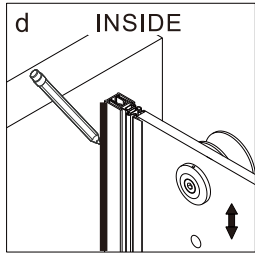
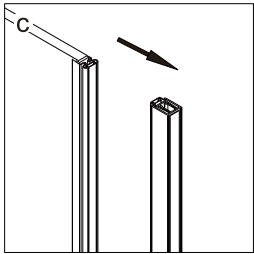
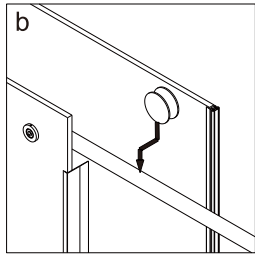
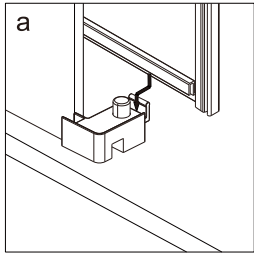
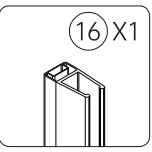
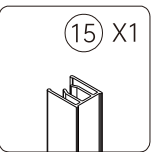
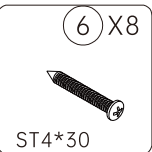
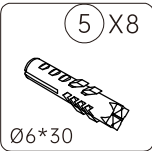

# 08

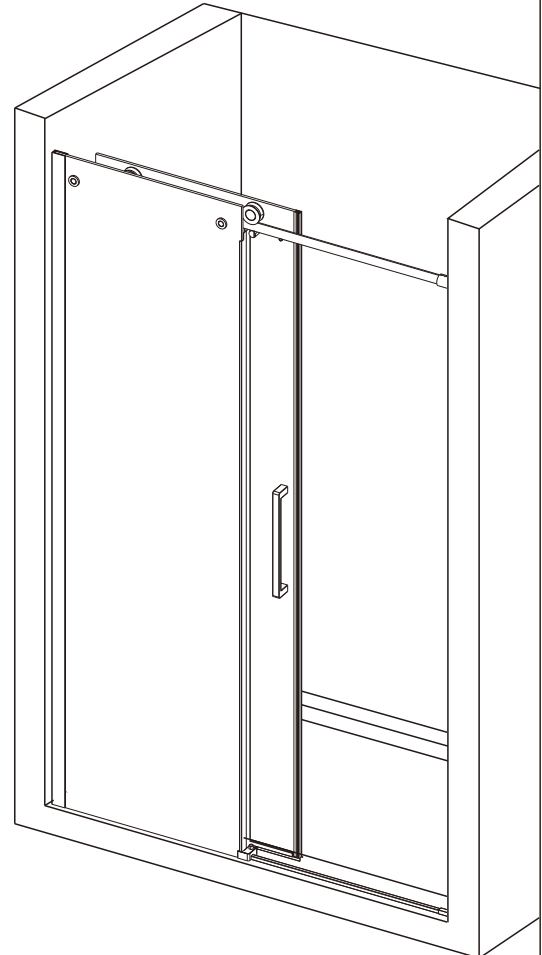
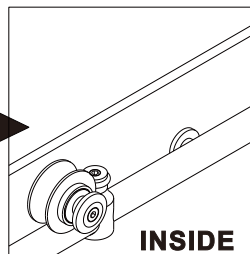
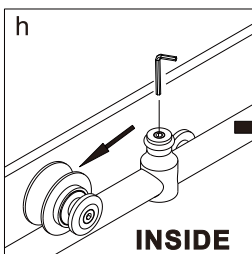
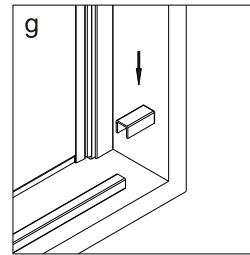
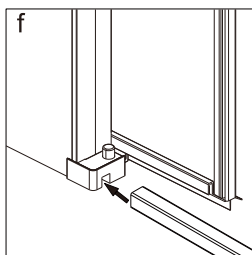
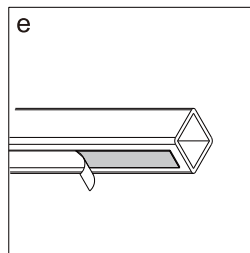
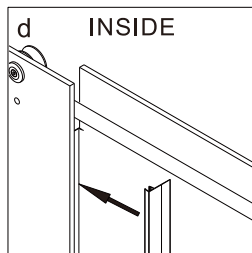
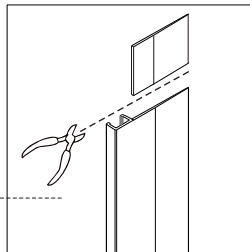
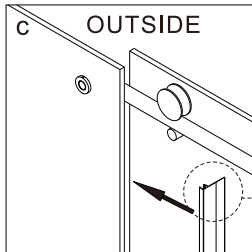
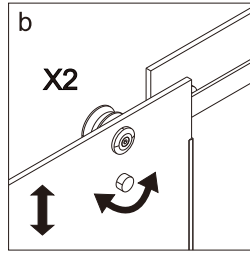
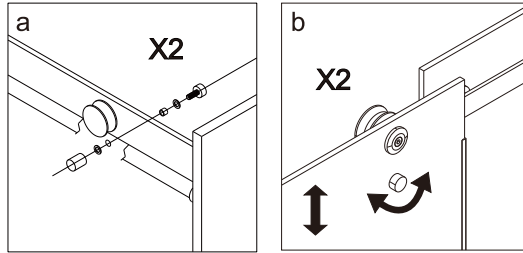
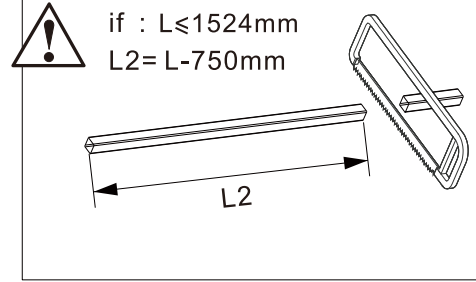
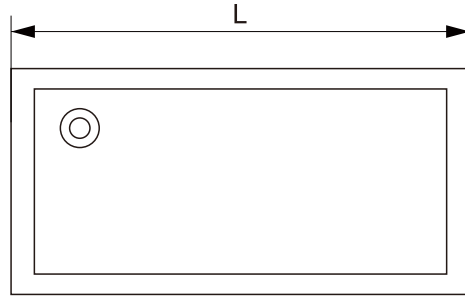
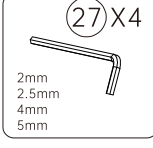
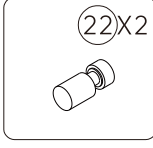
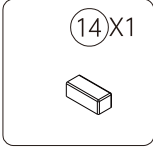
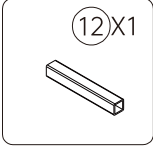
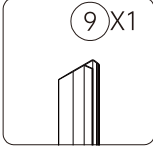
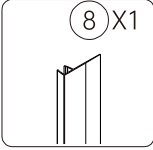

09

3 X2  

25 X2  
