

Install Handles

VWINSTON1036

STEP 1

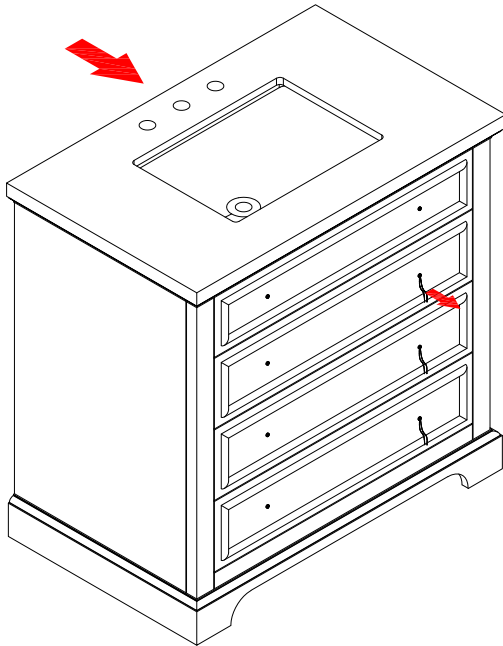

Please first use the rope on the screw to open the drawer, or push down the drawer from the back panel hole to open it.

STEP 2

Screw Driver

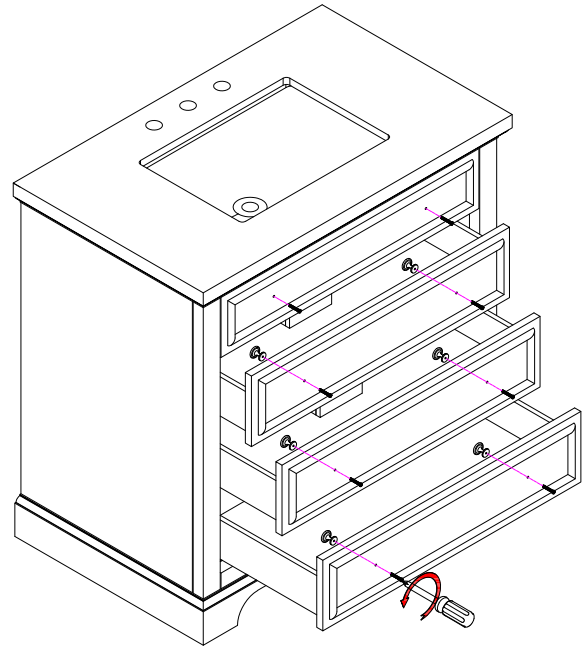

UNSCREW

STEP 3

Screw Driver

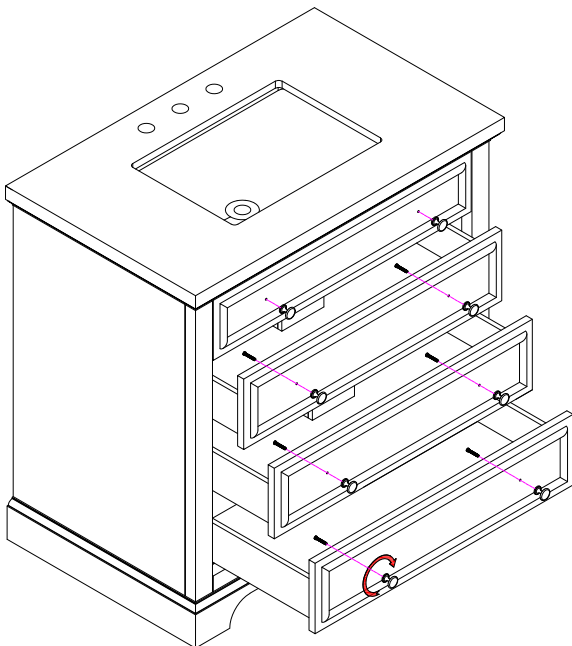

INSTALL HANDLES

STEP 4

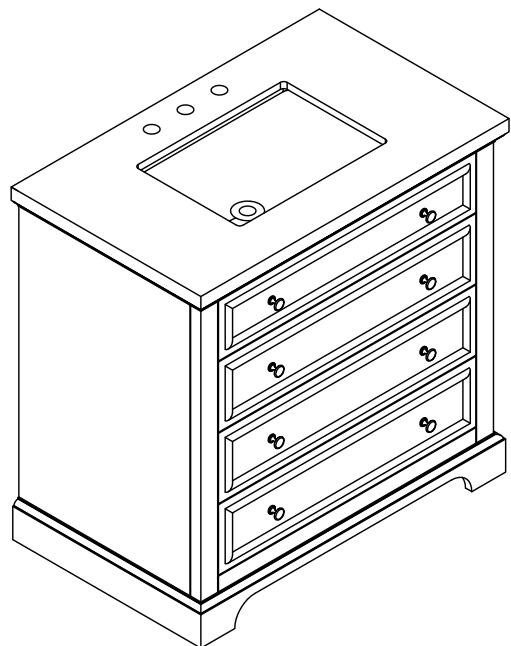

Install Backsplash

VWINSTON1036

STEP 1

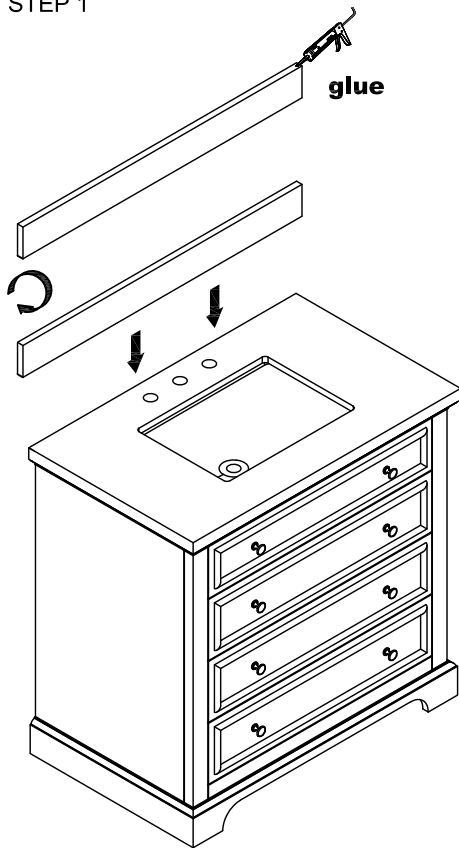

STEP 2

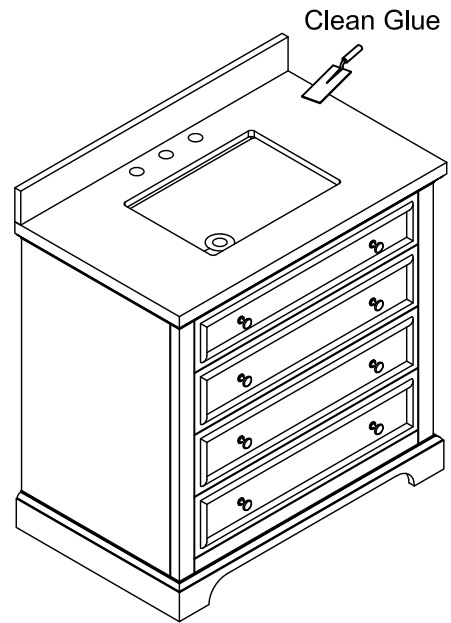

STEP 3

