

IMPORTANT, RETAIN FOR FUTURE REFERENCE: READ CAREFULLY

ASSEMBLY & INSTRUCTION MANUAL

PARTS

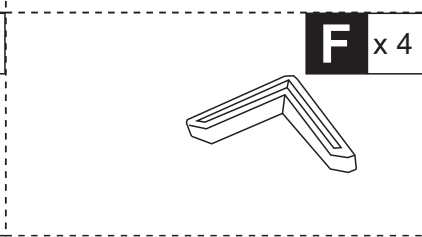
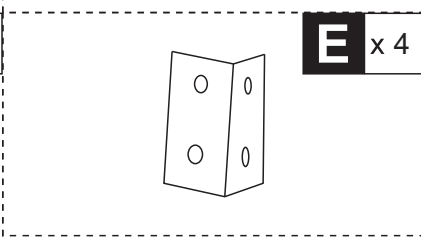
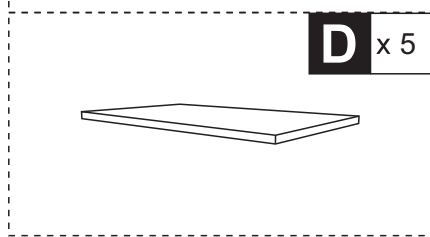
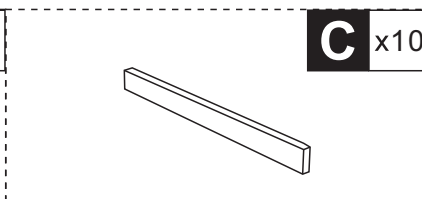
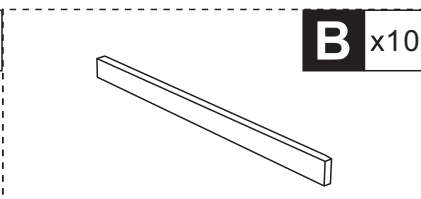
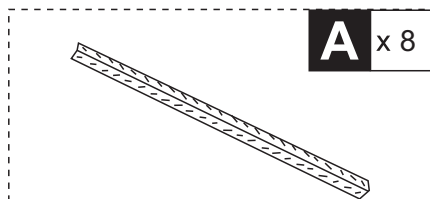

HARDWARE

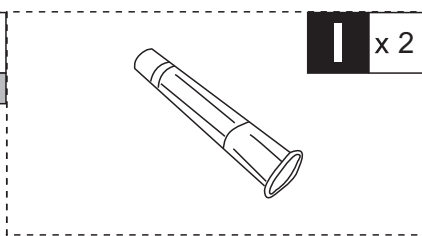
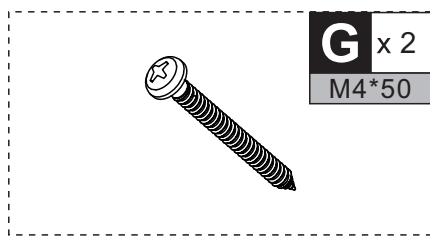

01

A x 1

F x 1

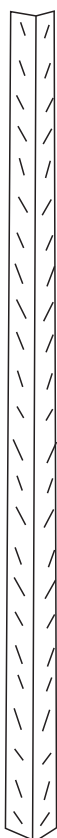

A



F

x4

02

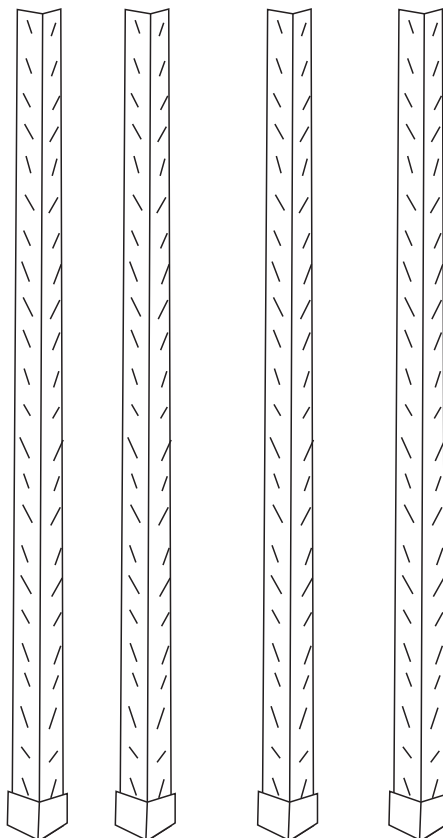

B x 2

C x 2

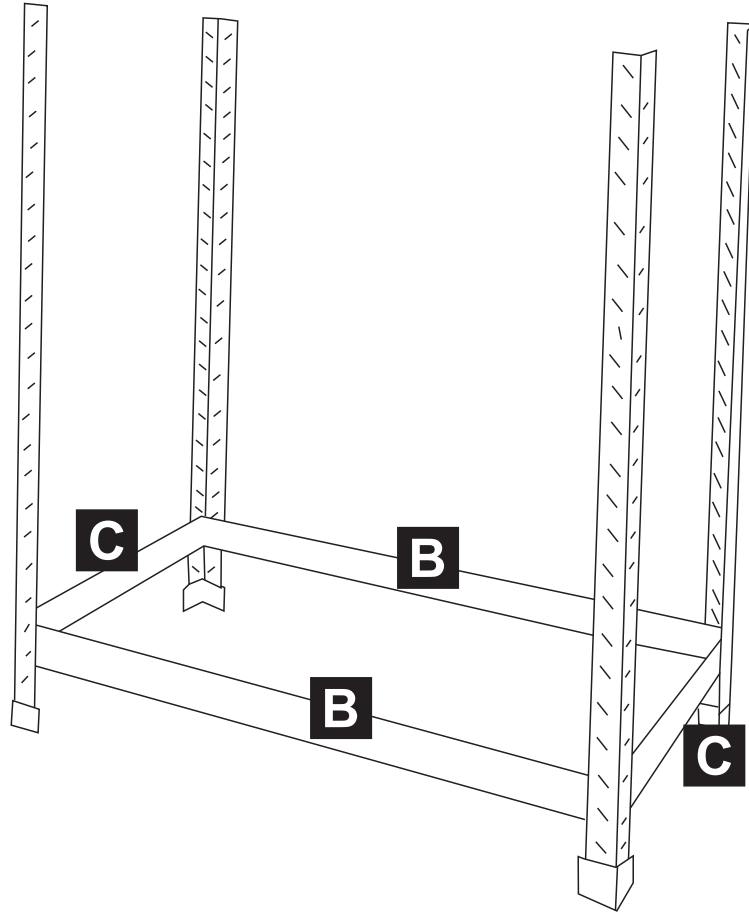

E x 4

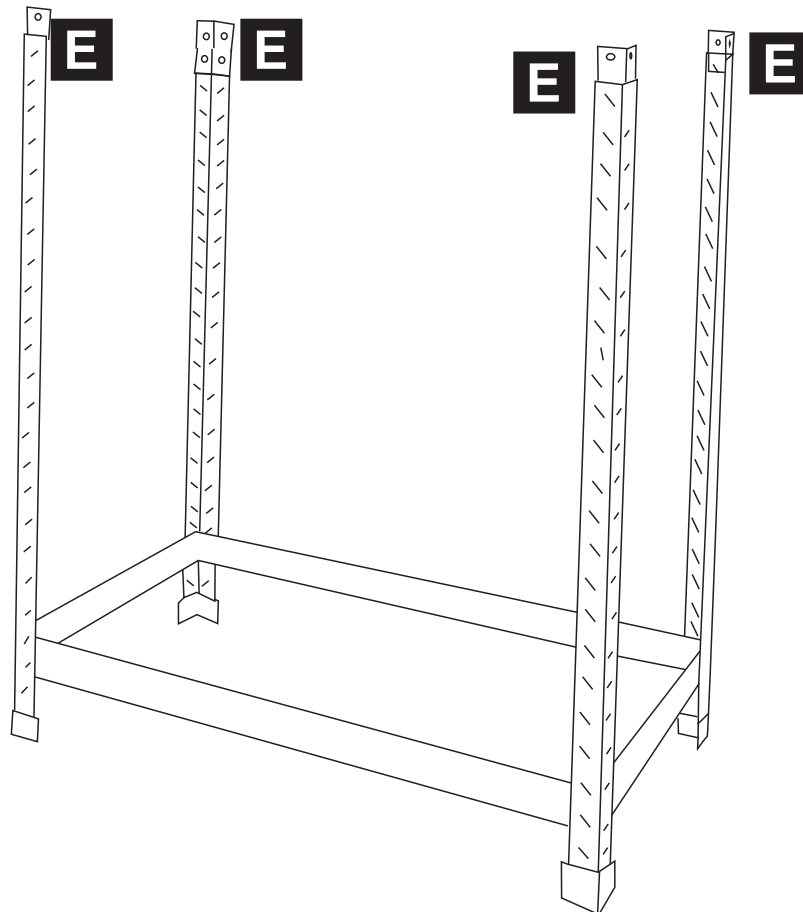

A x 4

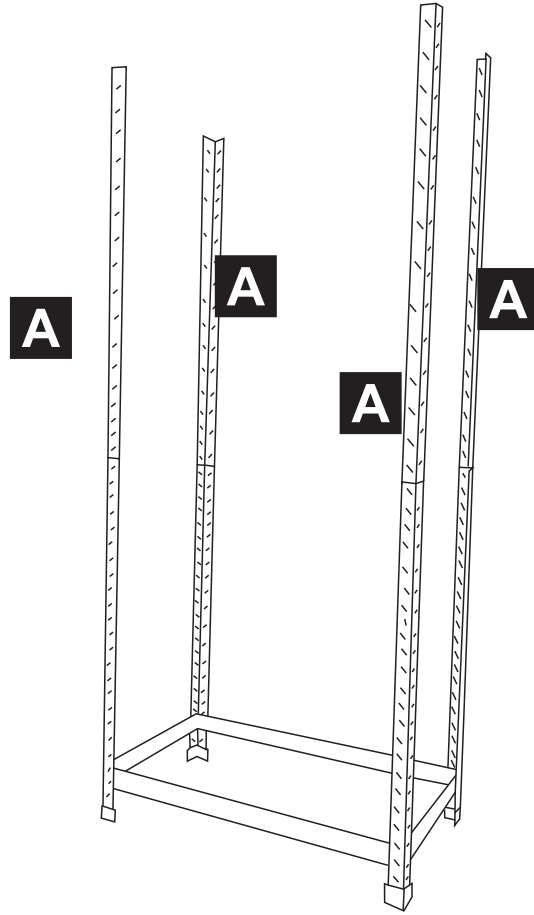

B x 2

C x 2

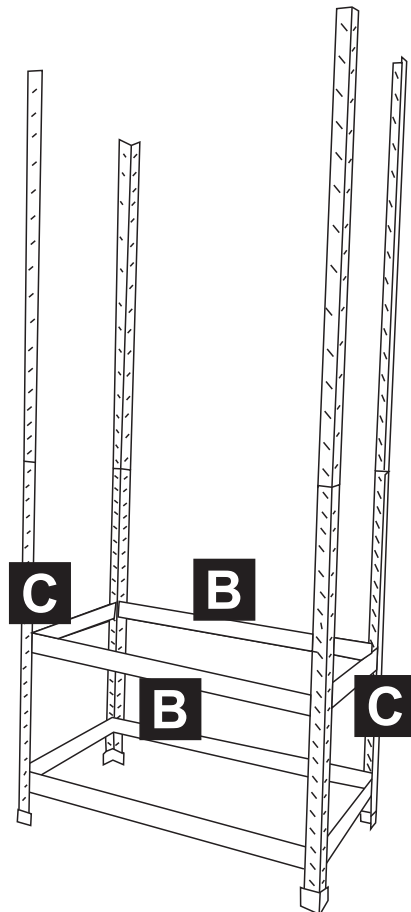

B x 2

C x 2

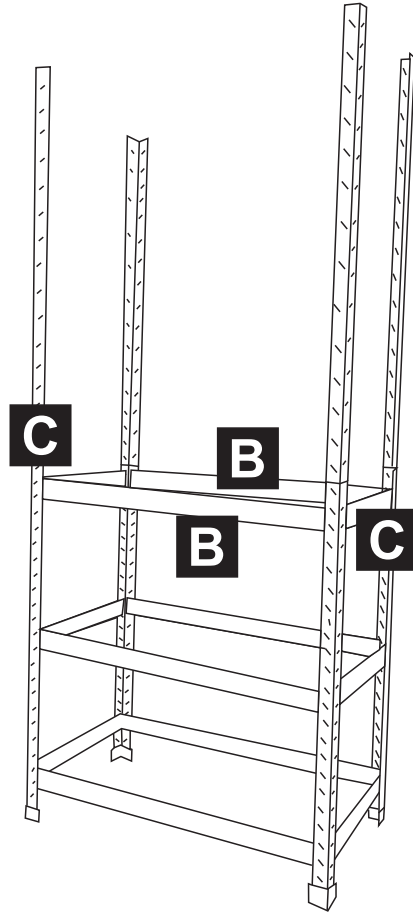

B x 2

C x 2

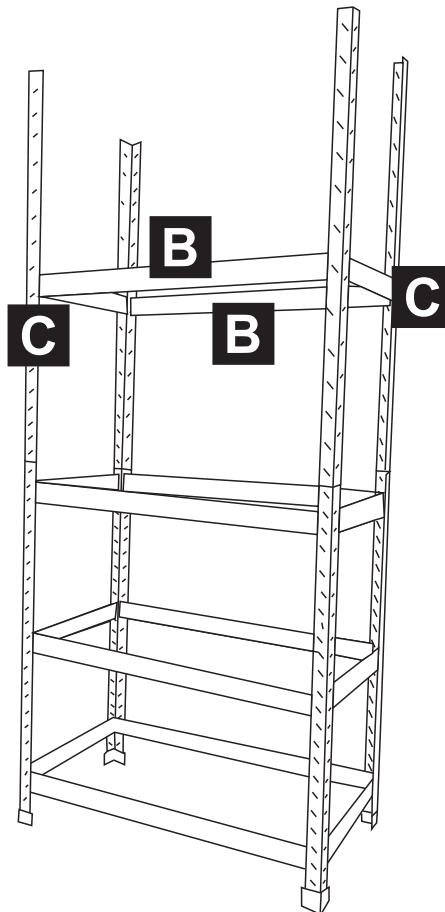

B x 2

C x 2

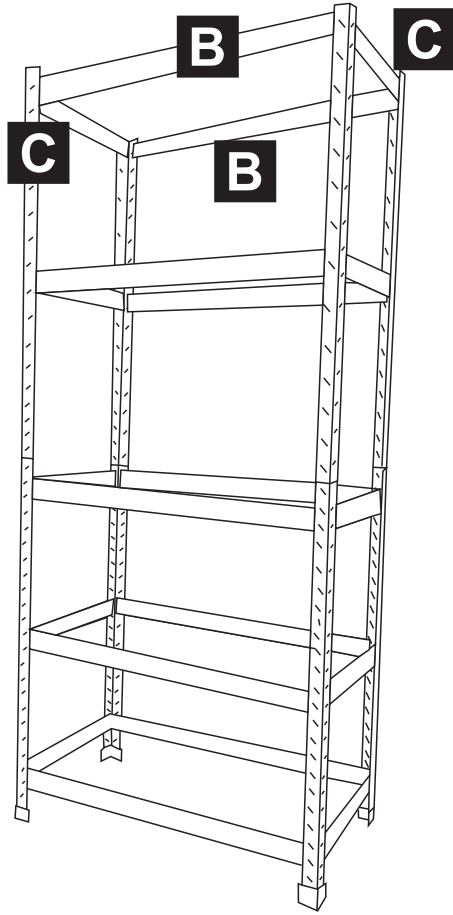

D x 5

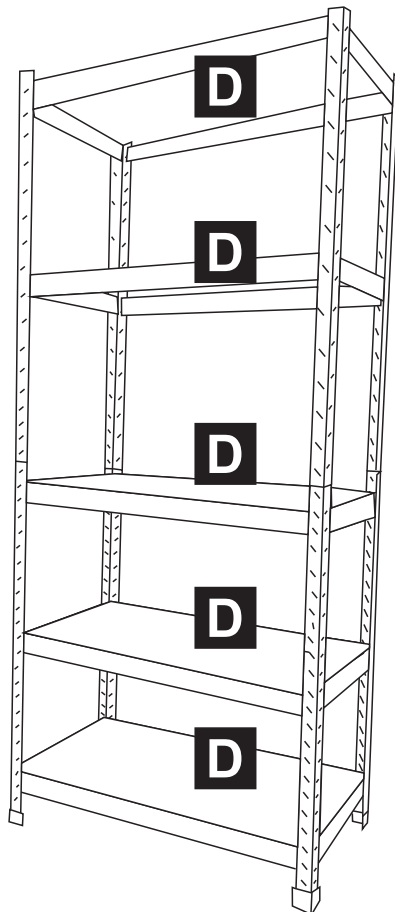

G x 2
M4*50

H x 2
M4

I x 2

