

1. Locate Studs / Level Line

(recommended creating guidelines)

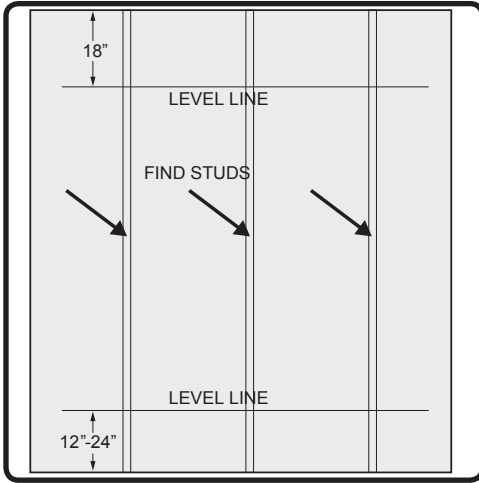

2. Align Panel to Studs and Level Line

(recommended 8-12 screws per 4' panel)

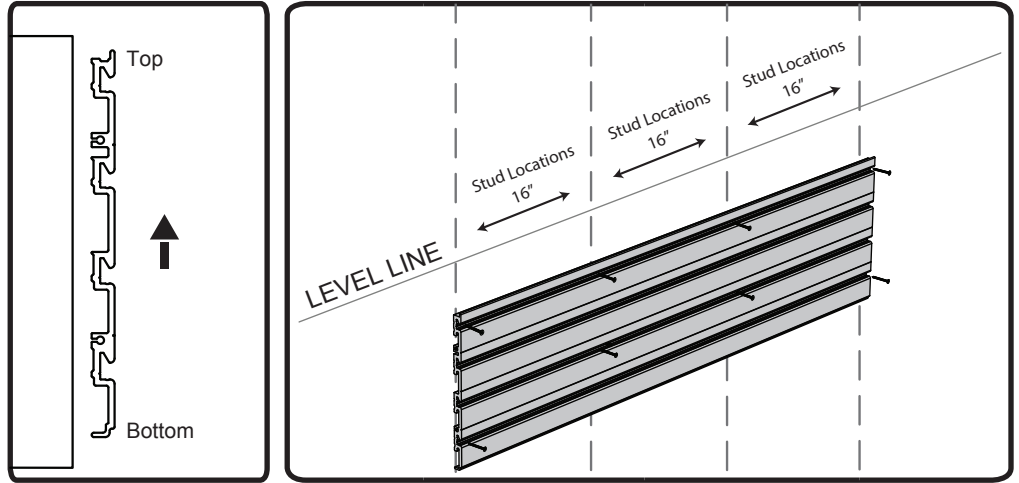

3. Mount Panel to Studs

(recommended 12 - FLOW 2" Screws)

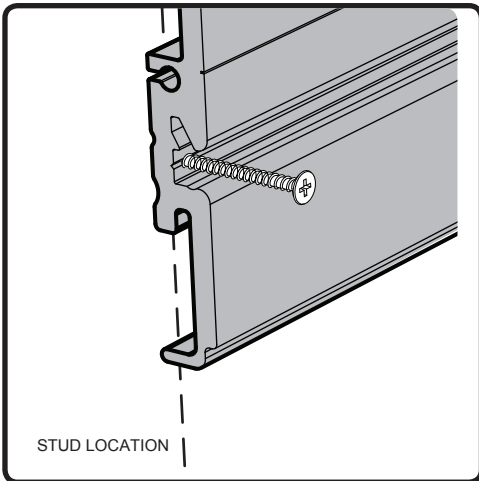

4. Horizontal Mounting

(use dowels to connect boards)

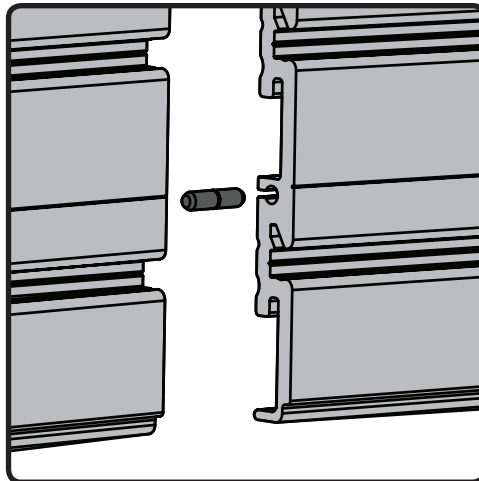

5. Vertical Mounting

(overlap panels)

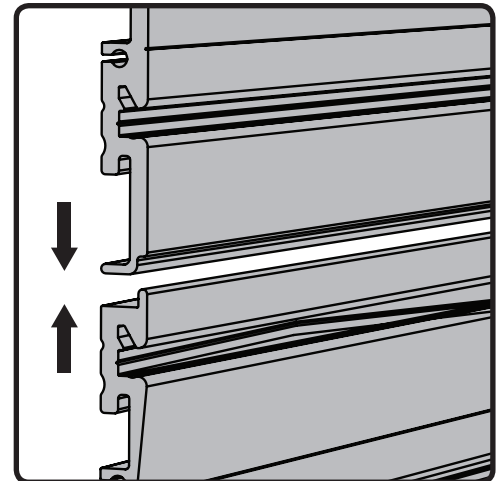

6. Attaching End Caps

(left edge start from bottom / right edge start from top)



Orientation Options

(using 6 Panels)

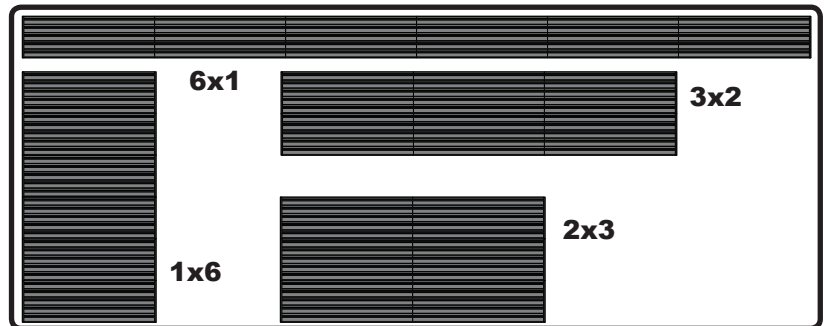

7. Placing Hooks

(insert from top to bottom)

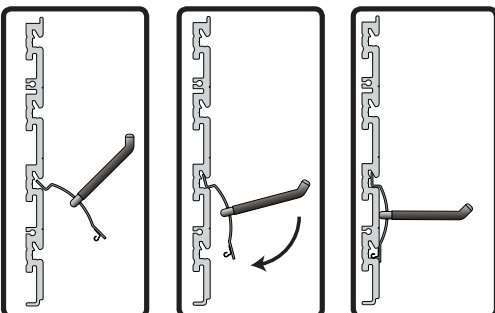

visit: www.flowwall.com

Thank you for your purchase from Flow Wall! 100% customer satisfaction is our goal. Please contact us between **9am-5pm** MST, Monday through Friday, with any questions.

1775 W 2300 S
Salt Lake City, UT 84119
(888) 353-0917
customerservice@flowwall.com