

Thank you for your purchase!



Metal Loft Bed With Desk

ASSEMBLY INSTRUCTIONS

Before You Begin:

Please identify all component parts and hardware pieces required before you begin. Carefully remove all of the components from the packaging and set aside for assembly. Assemble on a soft surface to prevent scratching during assembly.

Caution:

Tighten all components securely before use. Failure to do so may result in personal injury. DO NOT use any sharp objects to open plastic wrapped components as damage to product or components may result.

Warning:

CHOKING HAZARD - Small Parts. Adult Assembly Required.

DO NOT ALLOW CHILDREN TO CLIMB ON FURNITURE

Serious or fatal injuries can occur from furniture tipping over. You must install Tipping Restraint Hardware (where included) to help prevent the unit from tipping and causing accidental injury, instability, death or damage. The tipping restraint is intended only as a safety measure, it is not a substitute for proper adult supervision.

To help prevent furniture from tipping over it must be permanently attached to the wall. Anti-Tip Safety Wall Straps suitable for the unit weight and wall materials (if not included) should be purchased and installed.

Safety Warnings

- Follow the information on the warnings appearing on the upper bunk end structure and on the carton. Do not remove warning label from bed.
- Always use the recommended size mattresses or mattress supports, or both, to help prevent the likelihood of entrapment or falls.
- Surface of mattress must be at least 5 in. (127 mm) below the upper edge of guardrails.
- Do not allow children under 6 years of age to use the upper bunk.
- Periodically check and ensure that the guardrail, ladder, and other components are in their proper position, free from damage, and that all connectors are tight.
- Do not allow horseplay on or under the bed and prohibit jumping on the bed.
- Always use the ladder for entering and leaving the upper bunk.
- Do not use substitute parts. Contact the manufacturer or dealer for replacement parts.
- Use of a night light may provide added safety precaution for a child using the upper bunk.

- Always use guardrails on both long sides of the upper bunk. If the bunk bed will be placed next to the wall, the guardrail that runs the full length of the bed should be placed against the wall to prevent entrapment between the bed and wall.
- The use of water or sleep flotation mattresses is prohibited.
- **STRANGULATION HAZARD**–Never attach or hang items to any part of the bunk bed that are not designed for use with the bed; for example, but not limited to, hooks, belts and jump ropes.
- Keep these instructions for future reference.



WARNING:

Quality and Safety Guidelines:

- Never allow a child under 6 years of age on upper bunk.
 - Use only mattresses which are 74" - 75" long and 37.5" - 38.5" wide on the upper bunk.
 - Ensure thickness of the mattress does not exceed 9" and that the mattress is at least 5" below the upper edge of guardrails.
 - Use guardrails on both sides of the upper bunk.
 - Prohibit horseplay on or under the bunk/loft bed.
 - Do not allow more than one person on the upper bunk.
 - Use the ladder for entering and leaving the upper bunk.
 - Use the loft bed wall anchors with this item. If you did not receive the wall anchors, please contact us
-
- Please use this item on a stable, level surface only. All loft bed legs should contact the flooring surface when in use. Do not use this item if any instability is detected.
 - This item is intended for lying down, do not climb or stand on this item.

STRANGULATION HAZARD:





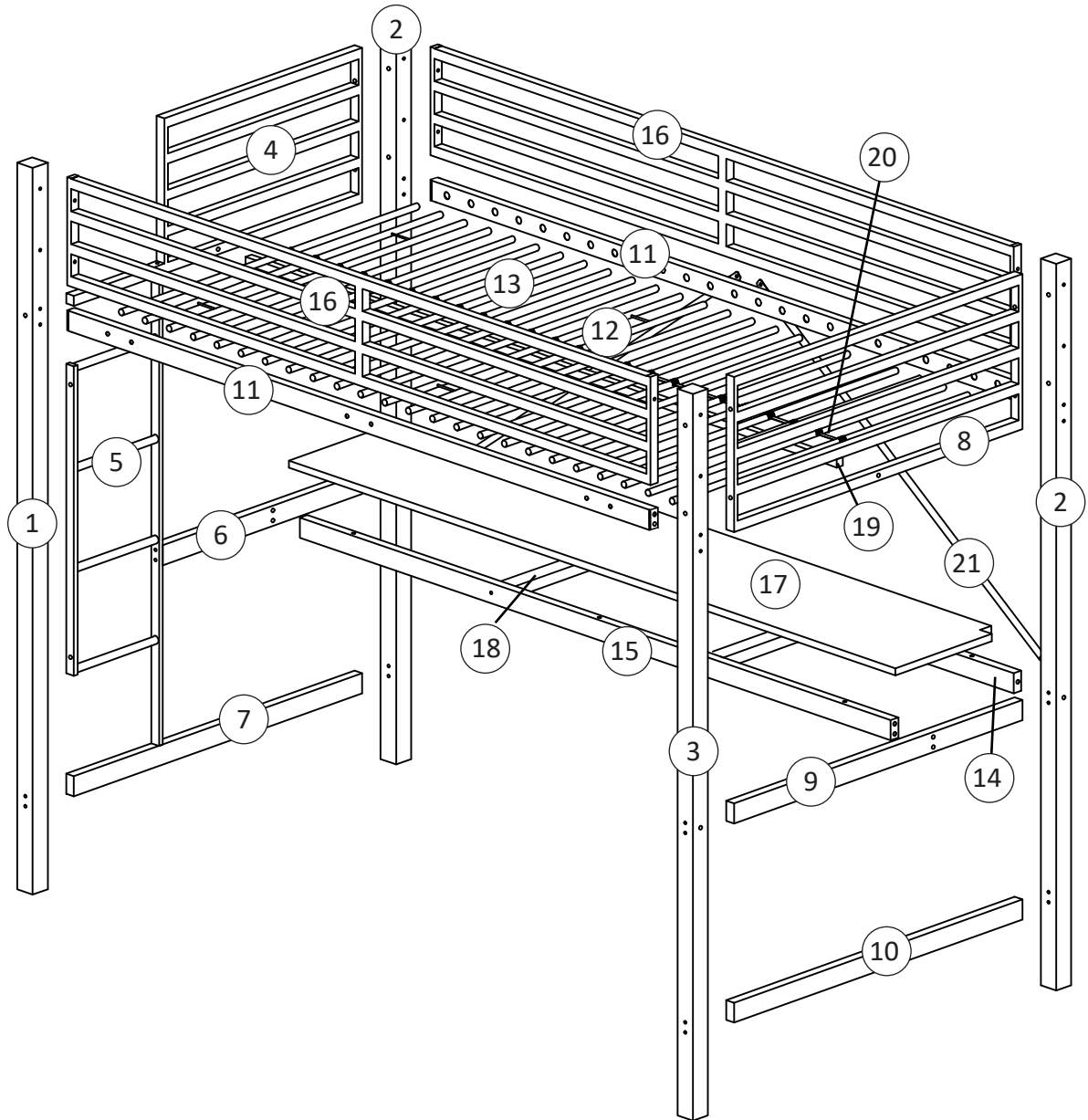

Never attach or hang items to any part of the bunk bed that are not designed for use with the bed including, but not limited to, hooks, belts and jump ropes.

ASSEMBLY INSTRUCTION

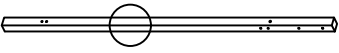
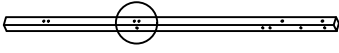

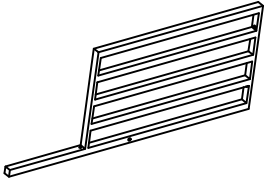
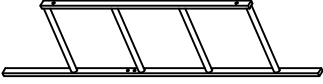
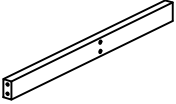
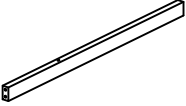
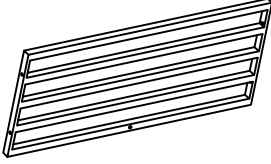
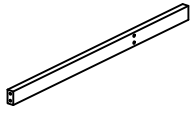
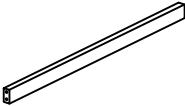
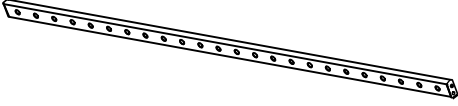
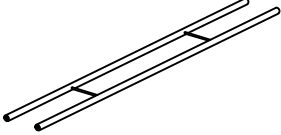
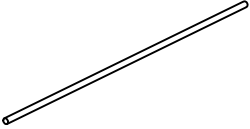
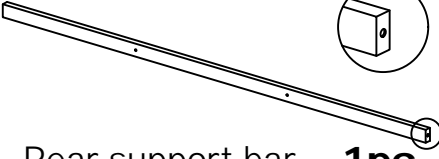
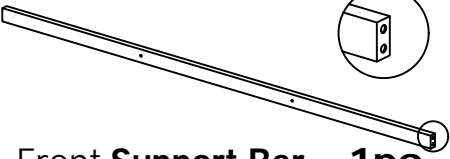
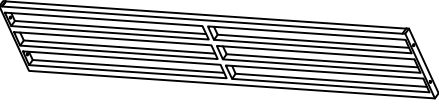
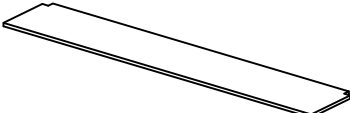

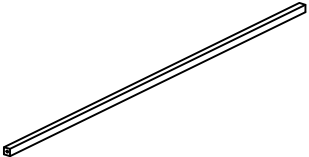
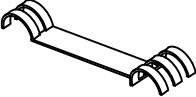









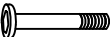

- Assembly requires 2 adults and approximately 2 hours to complete.
- The ladder section can be attached on either end of the loft bed. The two holes visible on part 6 and on part 9 must be aligned toward the rear of the bed for proper assembly of the desk supports and wooden desk top.

Part List





<p>1</p>  <p>Front Left Leg -1pc</p>	<p>2</p>  <p>Back Leg -2pcs</p>	<p>3</p>  <p>Front Right Leg -1pc</p>
<p>4</p>  <p>Footboard -1pc</p>	<p>5</p>  <p>Ladder -1pc</p>	<p>6</p>  <p>Left Connect Bar -1pc</p>
<p>7</p>  <p>Left Connect Bar -1pc</p>	<p>8</p>  <p>Headboard -1pc</p>	<p>9</p>  <p>Right Connect Bar -1pc</p>
<p>10</p>  <p>Right Connect Bar -1pc</p>	<p>11</p>  <p>Siderail -2pcs</p>	<p>12</p>  <p>Metal Slats 3pcs</p>
<p>13</p>  <p>Metal Slats -18pcs</p>	<p>14</p>  <p>Rear support bar -1pc</p>	<p>15</p>  <p>Front Support Bar -1pc</p>
<p>16</p>  <p>Guardrails -2pcs</p>	<p>17</p>  <p>Wooden Desktop -1pc</p>	<p>18</p>  <p>Support slat -2pcs</p>
<p>19</p>  <p>Middle rail -1pc</p>	<p>20</p>  <p>Plastic Brackets -23pcs</p>	<p>21</p>  <p>A frame -2pcs</p>

Hardware List

<p>A</p>  <p>Screws M6x16- 12pcs</p>	<p>B</p>  <p>Screws M6x25- 2pcs</p>	<p>C</p>  <p>Screws M6x35- 24pcs</p>
<p>D</p>  <p>Screws M6x45- 2pcs</p>	<p>E</p>  <p>Screws M6x50- 7pcs</p>	<p>F</p>  <p>Screws M6x60- 16pcs</p>
<p>H</p>  <p>Screws M8x60- 10pcs</p>	<p>J</p>  <p>Barrel Bolt M6- 14pcs</p>	<p>L</p>  <p>Small Washer M6- 37pcs</p>
<p>M</p>  <p>Big Washer M8- 10pcs</p>	<p>O</p>  <p>Allen Key M6- 1pc</p>	<p>P</p>  <p>Allen Key M8- 1pc</p>
<p>Q</p>  <p>Wall Brackets -2pcs</p>	<p>R</p>   <p>Expansion Screws M4X38-2pcs</p>	



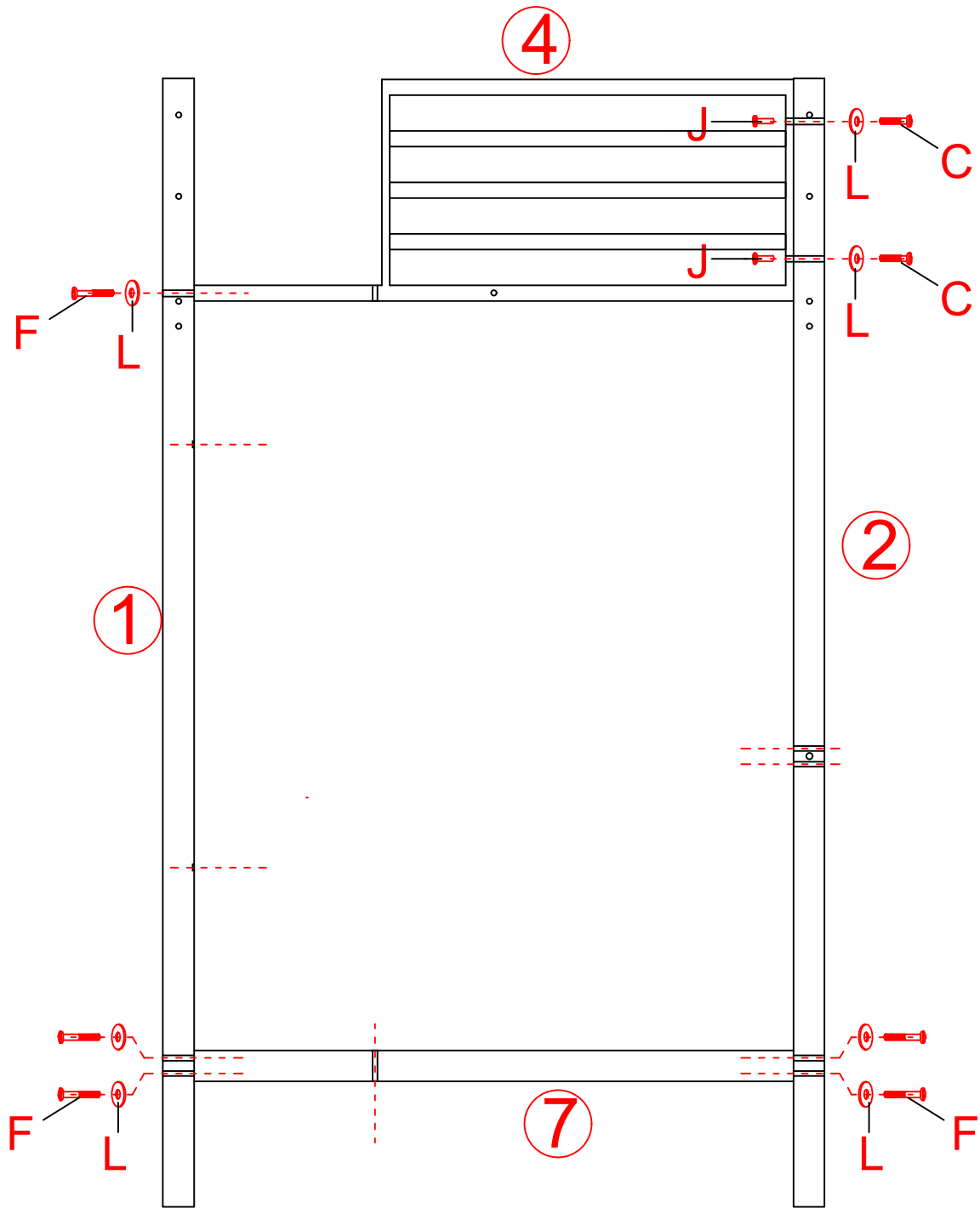

Step 1a:

Note: Do not fully tighten any screws until all assembly steps are completed.

C	F	J	L
 M6X35 (2pcs)	 M6X60 (5pcs)	 M6 (2pcs)	 M6 (7pcs)





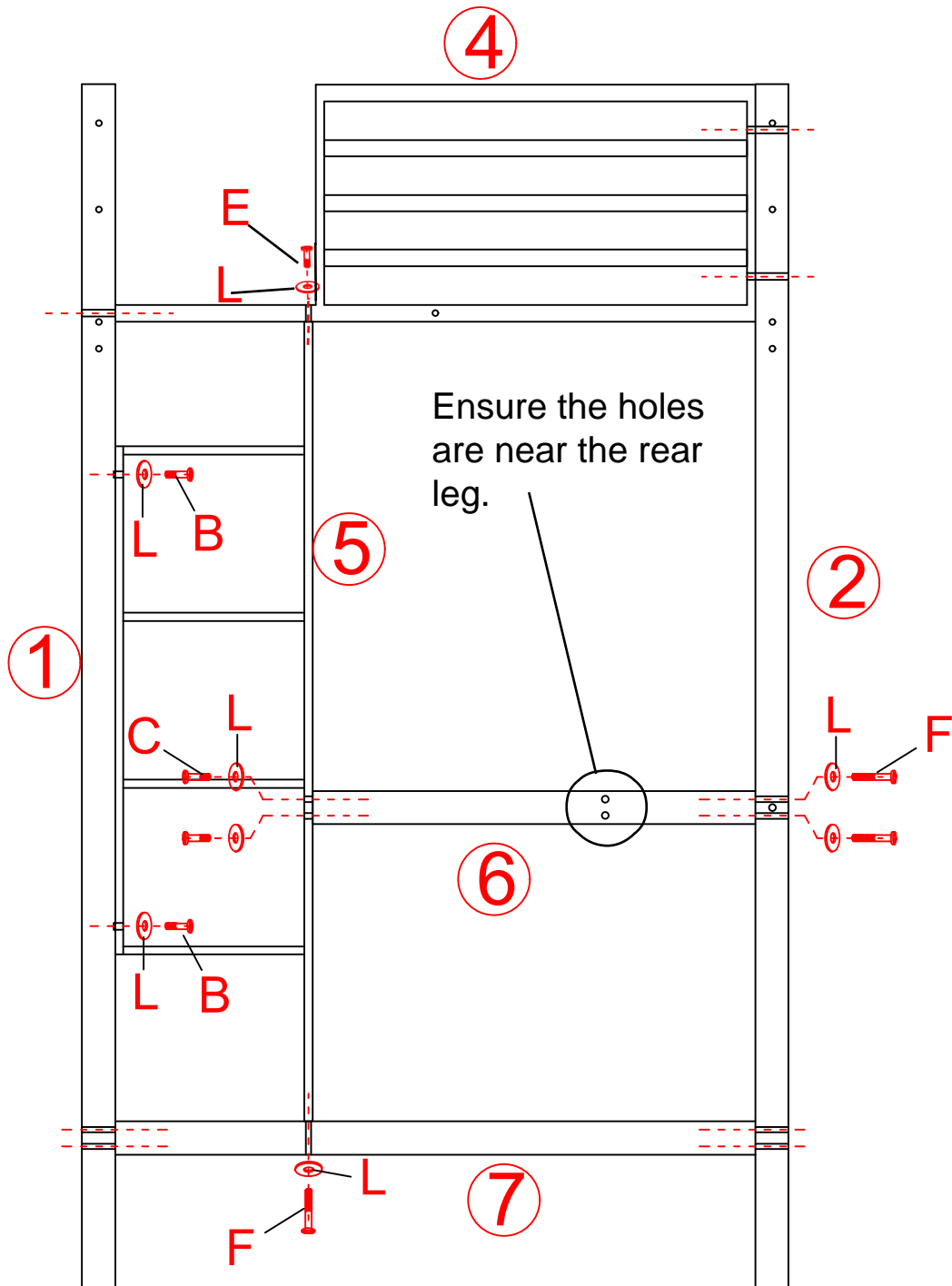

Step 1b:

B	C	E	F	L
				
M6X25	M6X35	M6X50	M6X60	M6
(2pcs)	(2pcs)	(1pc)	(3pcs)	(8pcs)



Step 2

C	F	J	L
 M6X35 (4pcs)	 M6X60 (8pcs)	 M6 (4pcs)	 M6 (12pcs)

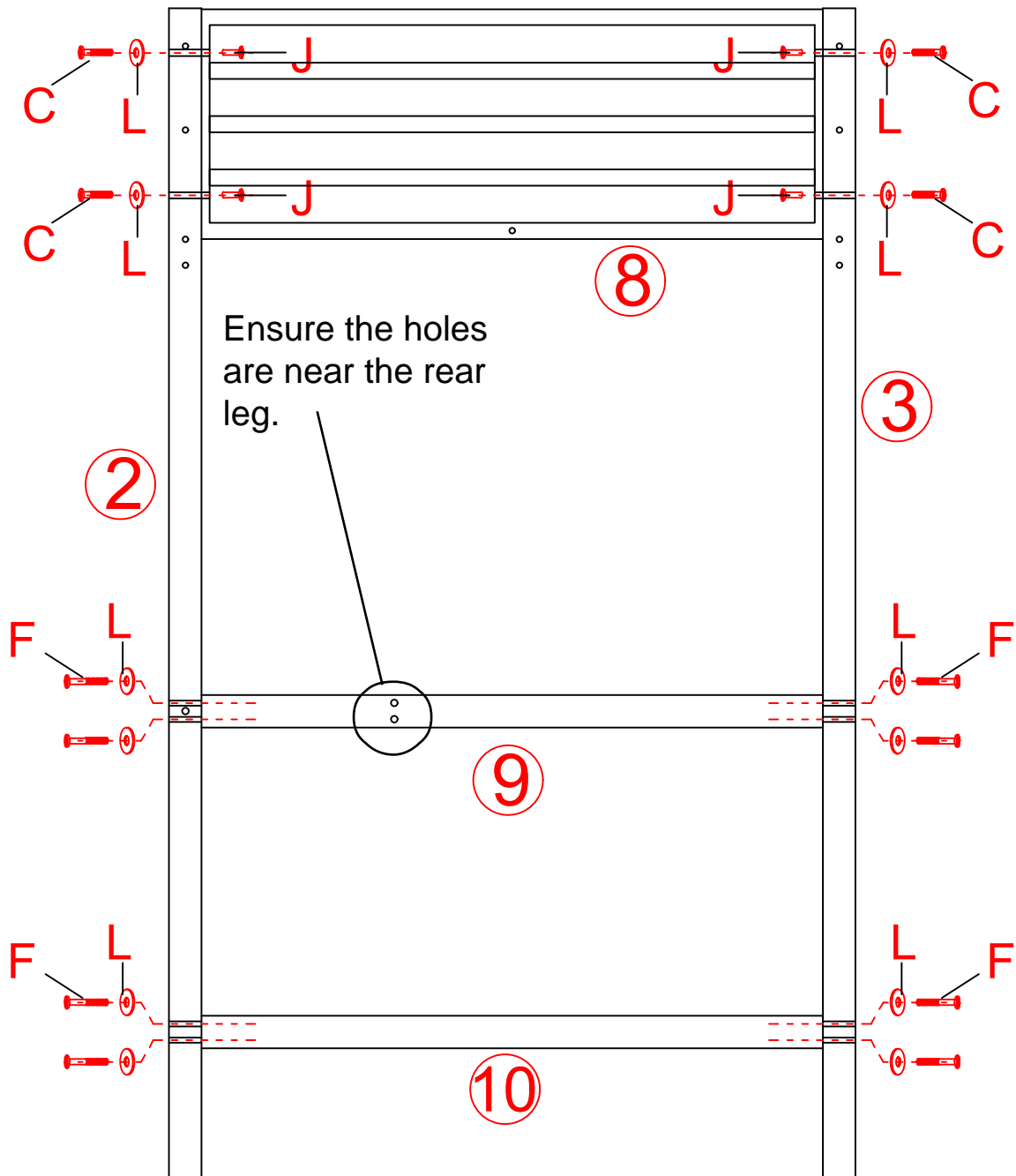

Step 3a:

Lean part 11 against a wall. Insert the metal slats into the holes that pass through both sides of part 11 and attach using the Part A bolts.

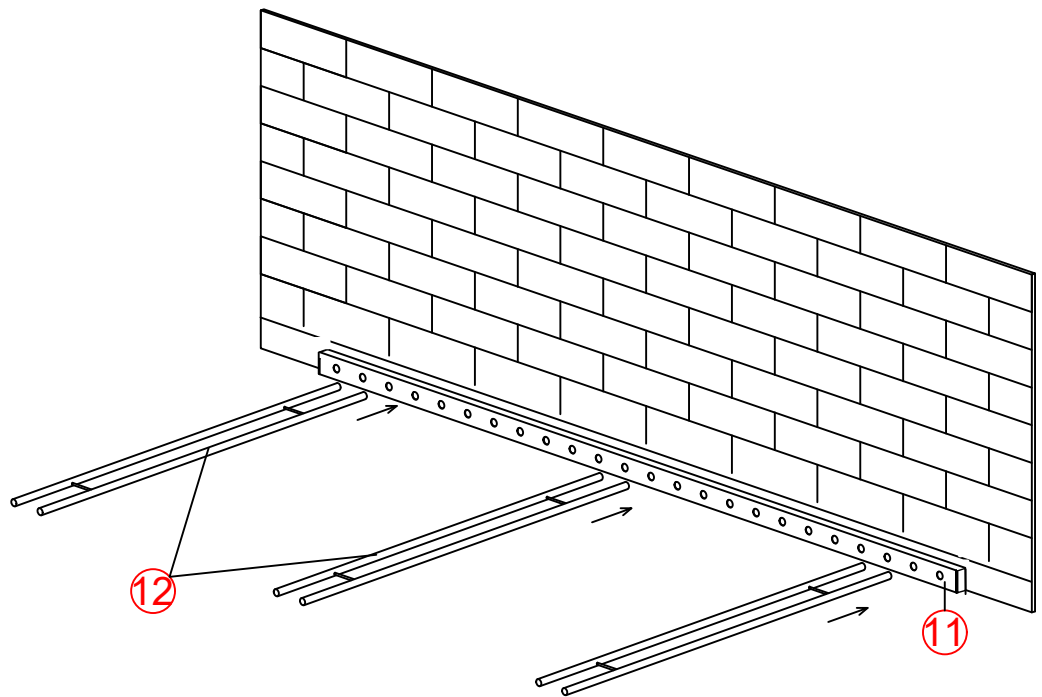

Step 3b: Insert part 13 pieces into the holes in part 11.

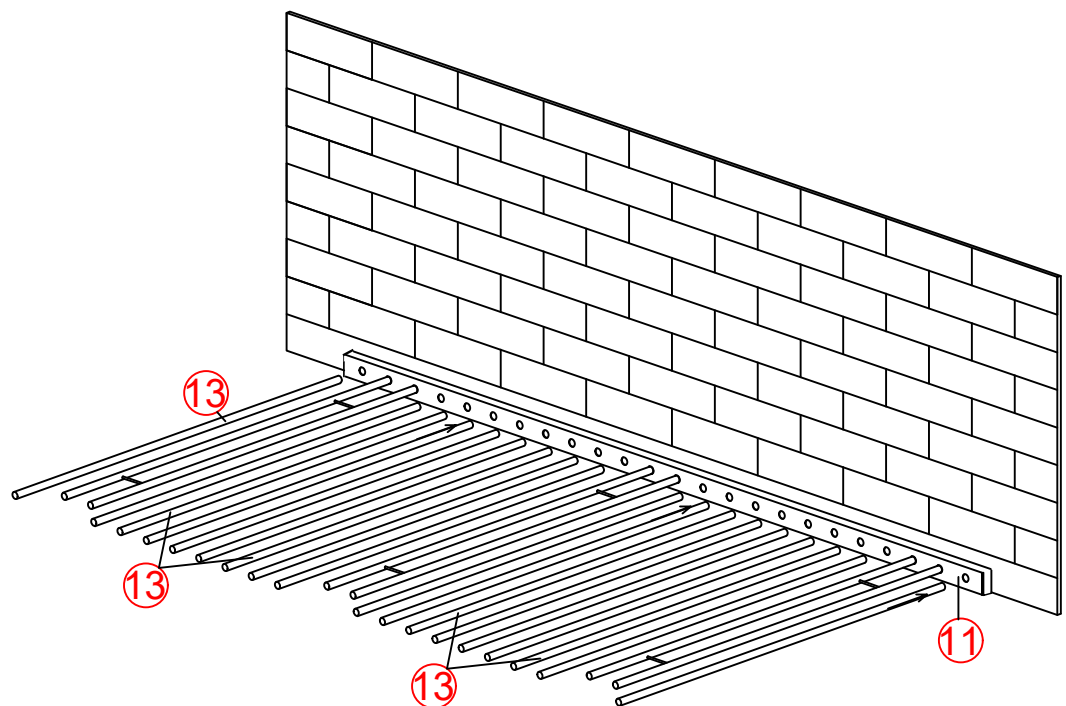

A

M6X16

(12pcs)

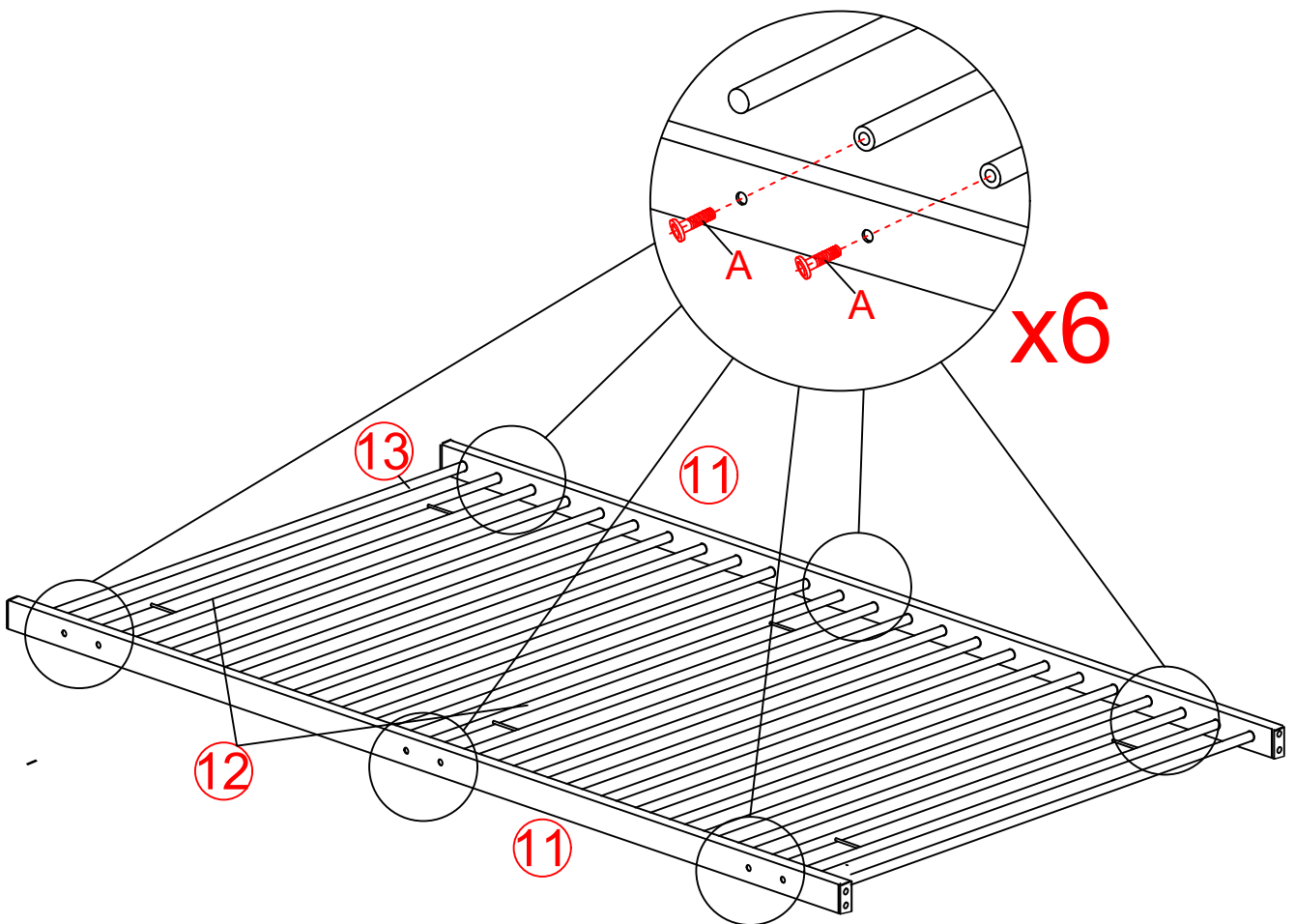

Step 3c:

Insert the other ends of parts 12 and 13 into the holes in the second siderail part 11 and attach parts 12 using the Part A bolts.



Step 4

Note: Help from a third adult may be helpful for this step.

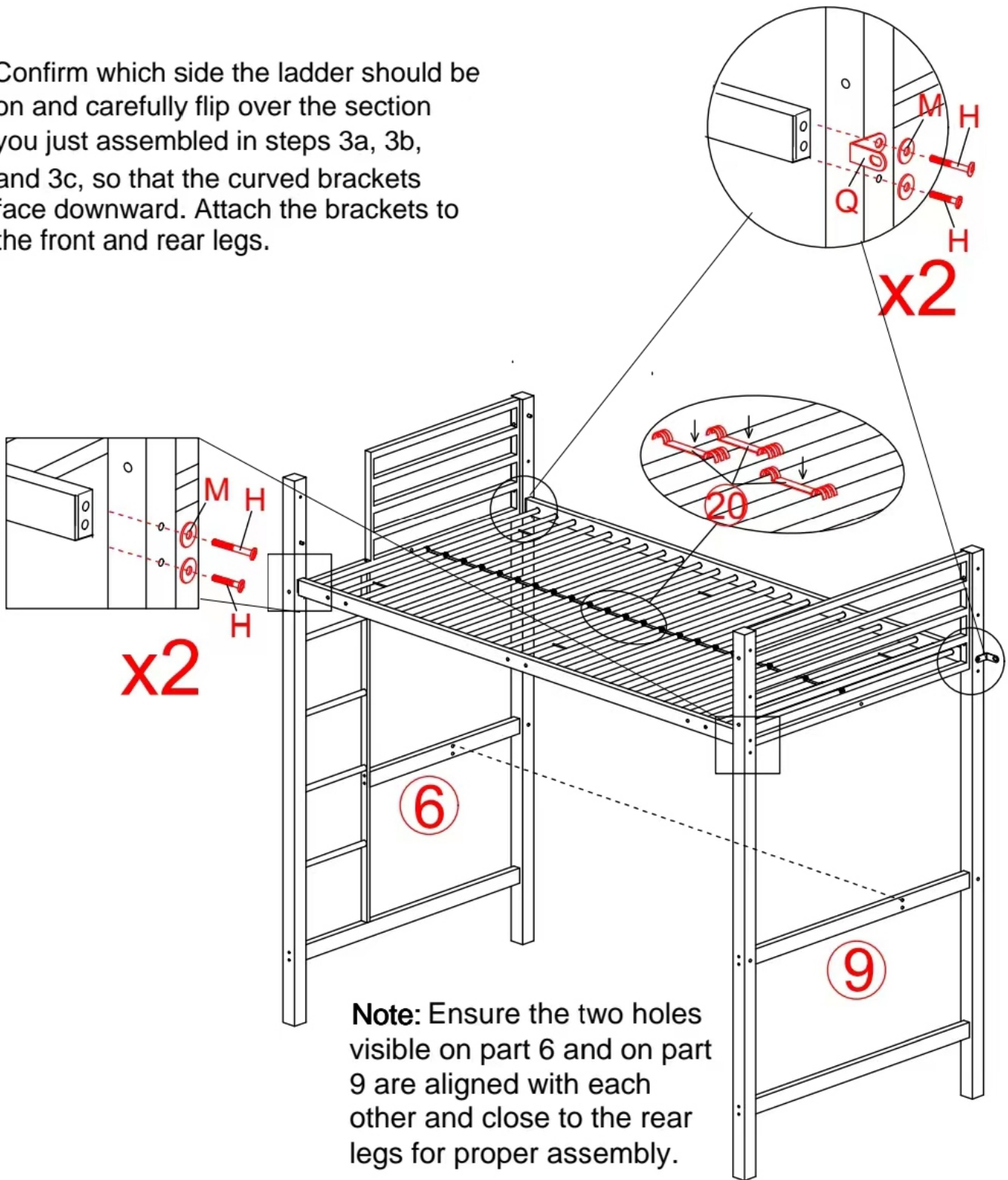

H	M	Q
 M8X60 (8pcs)	 M8 (8pcs)	 (2pcs)

Confirm which side the ladder should be on and carefully flip over the section you just assembled in steps 3a, 3b, and 3c, so that the curved brackets face downward. Attach the brackets to the front and rear legs.





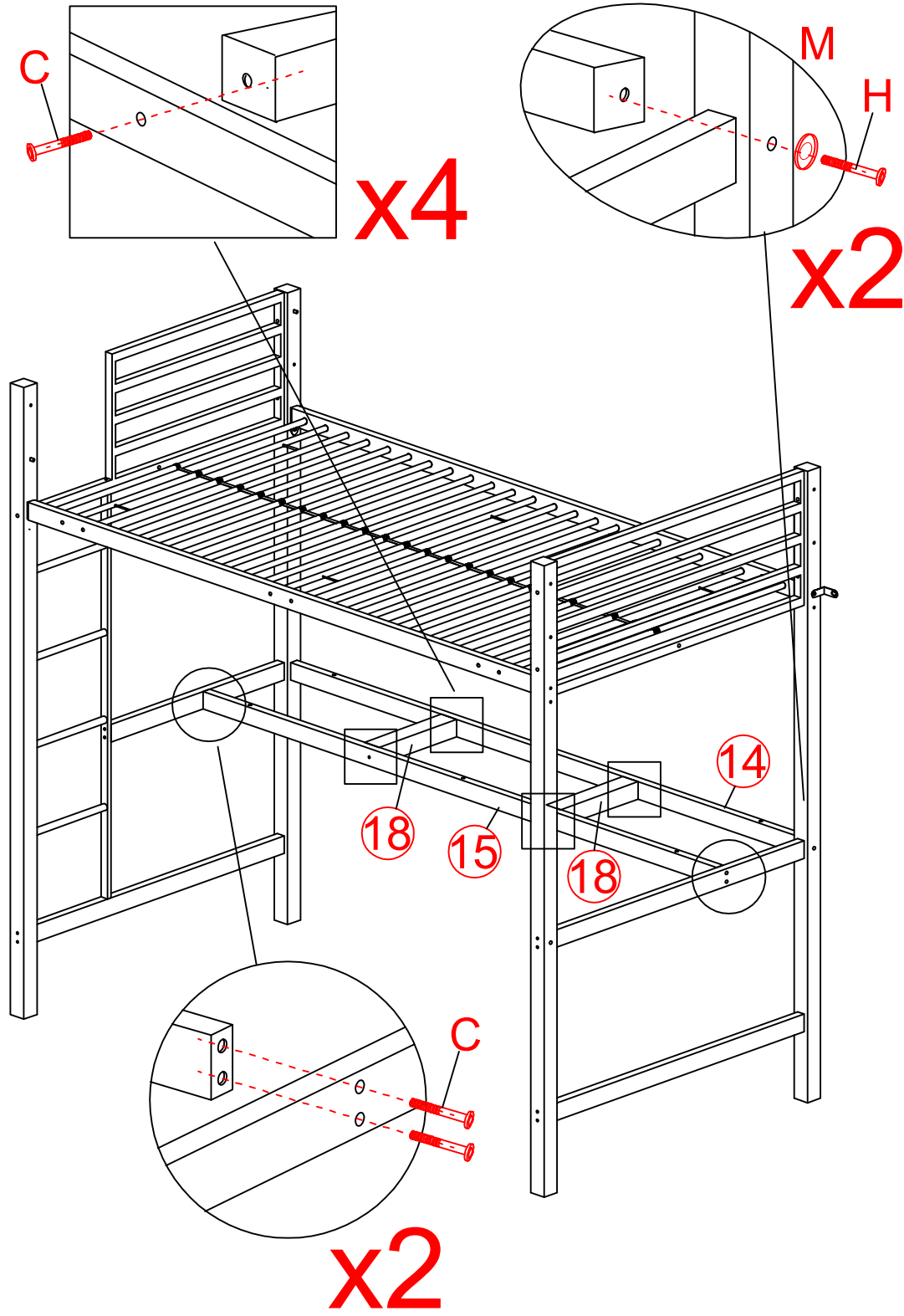

Note: Ensure the two holes visible on part 6 and on part 9 are aligned with each other and close to the rear legs for proper assembly.

Step 5

M	C	H
		
M8	M6X35	M8X60
2PCS	8PCS	2PCS



Step 6

C	D	J	L
			
M6X35	M6X45	M6	M6
(8pcs)	(2pcs)	(8pcs)	(10pcs)

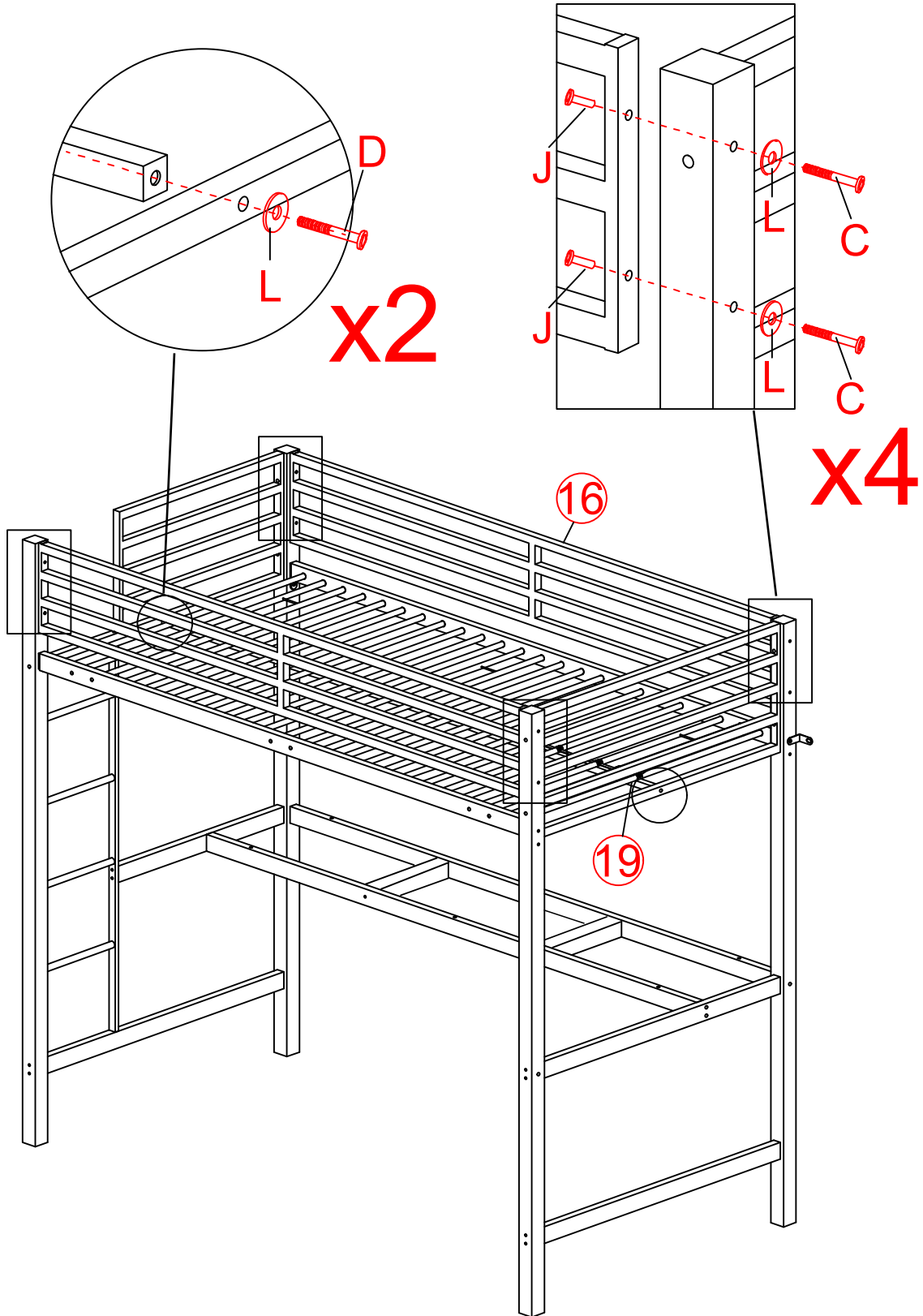

Step 7a

Attach the wooden desktop to the metal frame with part E bolts.

E



M6X50

(6pcs)

Step 7b

Ensure all screws from steps 1-6 are securely tightened.

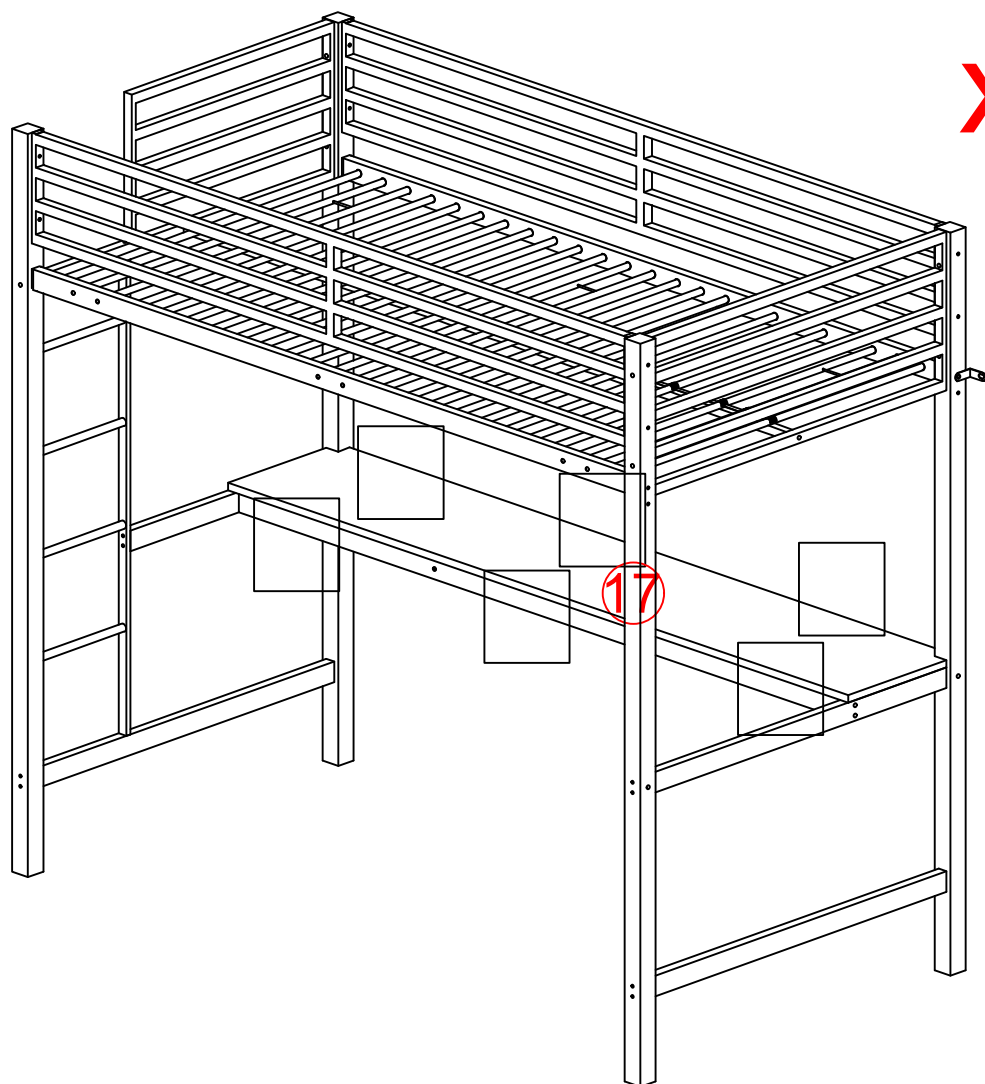
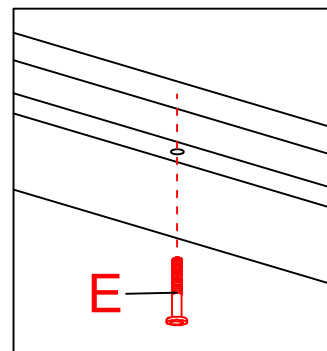

Step 8

