

A

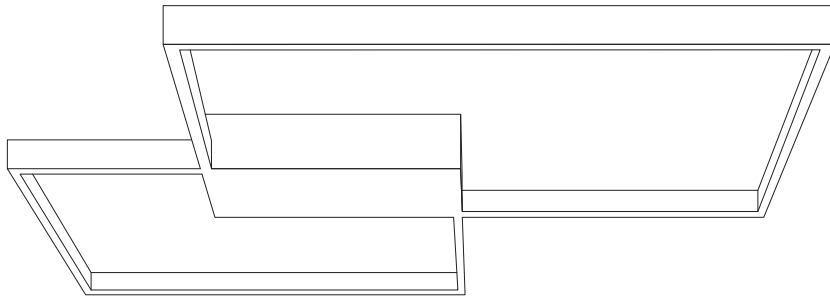

A

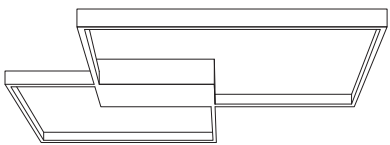

x 1

B

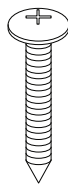

x 2

C



x 2

1

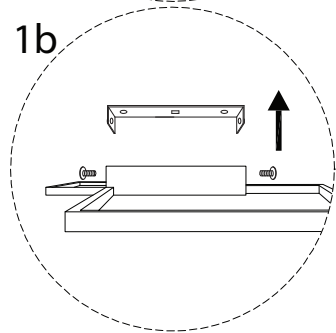
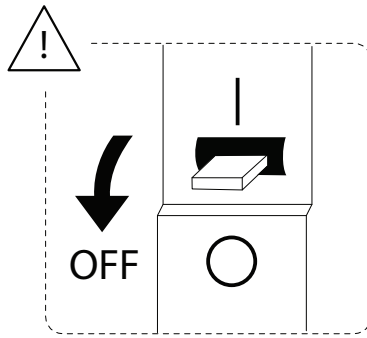
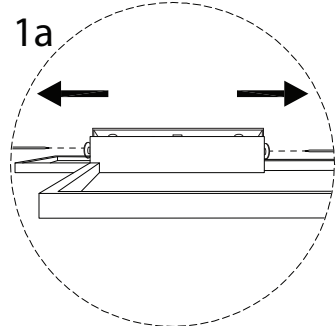
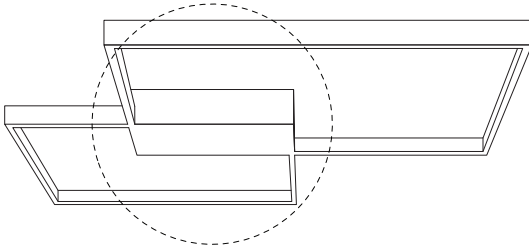
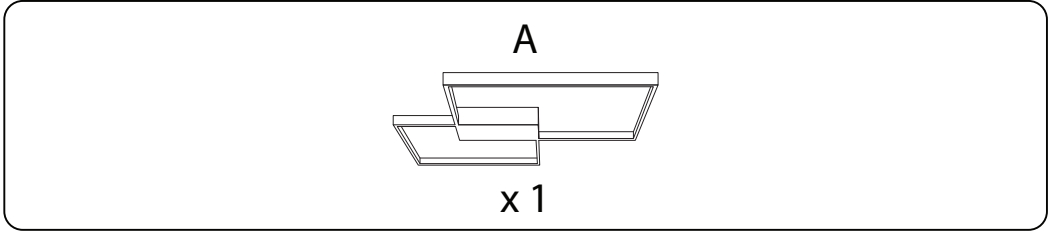

2

