

USER'S MANUAL

42-inch ceiling fan light

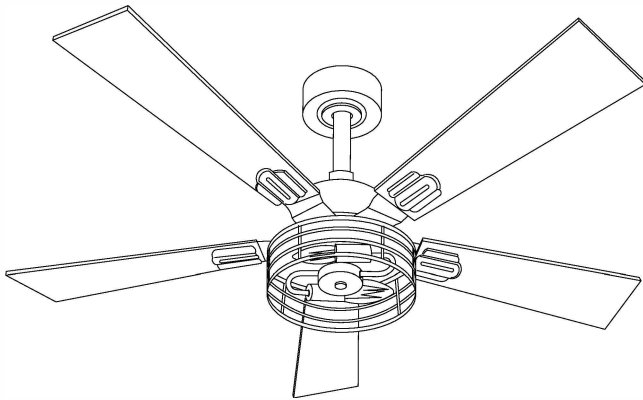

Warm Tips

Insert the downrod ball head into the groove of the mounting bracket. (Figure 1)

2. Using a full range dimmer switch to control fan speed will damage the fan.

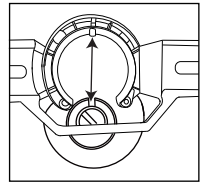

Figure 1

WARNING!!!

To avoid fire, shock and serious personal injury, follow these instructions.

1. Read your user's manual and safety information before installing your new fan. Review the accompanying assembly diagrams.
2. Before servicing or cleaning the unit, switch off the power at the service panel and lock the service panel to prevent power from being switched on accidentally. If the service disconnecting means cannot be locked, securely fasten a warning device, such as a tag, to the service panel.
3. Be cautious around the fan and blades when clearing, repairing, or working near the fan. Always turn off the power to the ceiling fan before performing any servicing.
4. Do not insert anything into the fan blades while the fan is operating.
5. This appliance is not intended for use by young children or individuals with disabilities without supervision. Young children should be supervised to ensure they do not play with the appliance.
6. Before installing your ceiling fan, refer to the section on the proper method of wiring your fan. If you feel that you do not have enough wiring knowledge or experience, it is recommended to have your fan installed by a licensed electrician.

Fan components

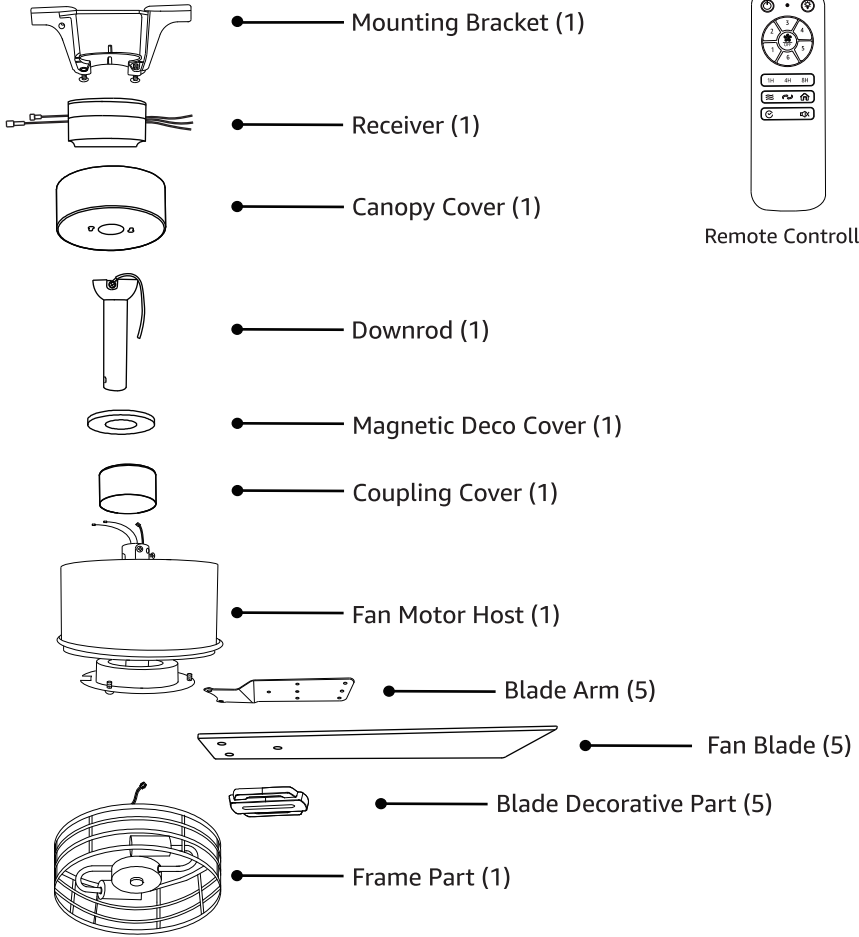

Energy Saving Usage

Ceiling fan performance and energy savings rely heavily on the proper installation and use of the ceiling fan. Here are a few tips to ensure efficient product performance.

Choosing the Appropriate Mounting Location

Ceiling fans should be installed or mounted in the middle of the room and positioned at least 7 feet above the floor and 18 inches away from the walls.

If the ceiling height allows, it is recommended to install the fan 7~9 feet above the floor to achieve optimal airflow.

Turn Off When Not in the Room

If the room is unoccupied, turn off the ceiling fan to conserve energy.

Using the Ceiling Fan Year Round

Summer Season: Use the ceiling fan in the counterclockwise direction. The airflow created by the ceiling fan produces a wind-chill effect, making you feel cooler. Select a fan speed that provides a comfortable breeze; lower speeds consume less energy.

Winter Season: Reverse the motor and operate the ceiling fan at a low speed in the clockwise direction. This produces a gentle updraft, which pushes the warm air near the ceiling down into the occupied space. Remember to adjust your thermostat when using your ceiling fan. This simple step can lead to additional energy and cost savings.

Electrical and Structural Requirements

Your new ceiling fan will require a grounded electrical supply line of AC 110-130V/60Hz and a 15 Amp circuit. According to electrical codes, it is necessary to use a fan-rated outlet box to support the additional weight and motion associated with a ceiling fan. A fan-rated box will be clearly labeled as such and is typically designed to support ceiling fans weighing up to 70 pounds.

Fan-rated outlet boxes are available in various ratings and designs. It is essential to ensure that the rating of your ceiling fan outlet box meets the requirements for the specific ceiling fan you are installing. Please refer to the figures below for different structural configurations that can be used for mounting the outlet box.

Low-profile use (Figure 1)

A 1/2-inch deep pancake box is meant to be screwed to a joist or block. It is used if only one cable is coming into the box. It is also available in a saddle-mount configuration.

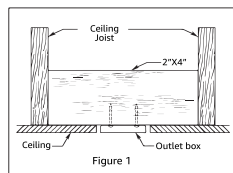

Deep-profile use (Figure 2)

A 2-1/4" deep box can be attached to blocking between joists and is roomy enough to handle more than one cable.

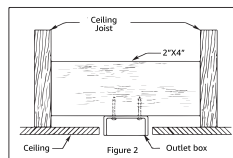

Brace Use (Figure 3)

Paired with a deep box, this hanger is meant to span between two joists and takes the place of wooden blocking.

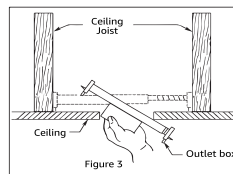

If your fan is to replace an existing light fixture, turn power off at the main fuse box and remove the existing light fixture.

WARNING

To ensure safety and prevent potential electrical shock, it is not sufficient to simply turn off the wall switch. Prior to wiring, make sure to turn off the electricity at the main fuse box. All wiring should be done in accordance with national and local electrical codes. Additionally, it is important to properly ground the ceiling fan as a precautionary measure against possible electrical shock. Following these guidelines will help ensure the safe installation and operation of your ceiling fan.

Do not use a variable (rheostat) wall controller or dimmer switch to operate this fan. Doing so can cause damage to the ceiling fan's remote control unit. It is recommended to only use the provided remote control.

Installation

1

Cement ceiling

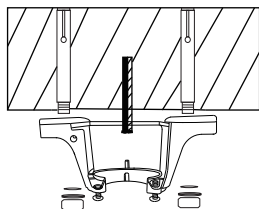

2

Wood ceiling

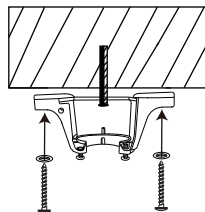

Junction-box

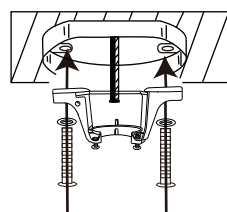

- Mount the bracket to the ceiling and use appropriate accessory screws to secure it based on the type of ceiling material.
- Cement ceiling: Drill holes into the cement ceiling, then utilize expansion screws or expansion tubes along with self-tapping screws for fixation.
- Wooden ceiling: Drive self-tapping screws directly into the wooden ceiling.
- Junction box: Secure the bracket to the ceiling using j-box screws and washers.

3

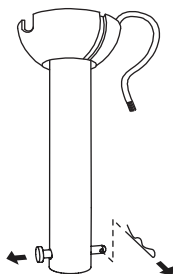

4

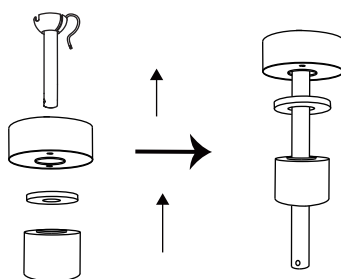

- Remove the downrod pin. (Please refer to the last page for instructions on how to replace the downrod.)
- Mount the canopy cover, coupling cover onto the downrod.

5

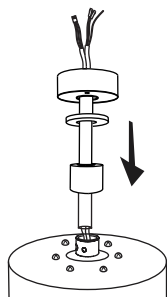

6

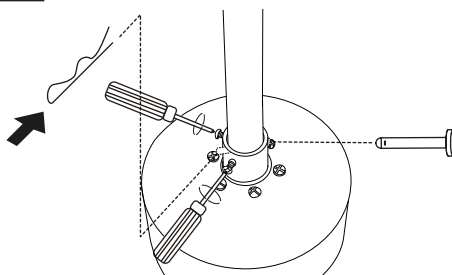

- Assemble the canopy and coupling cover as shown in the figure, thread the wires through the downrod. (If the wires blocked, please take out the pin on the ball head)
- Insert the downrod pin, lock it with the downrod clip, and then tighten the two screws on the yoke.

Installation

7

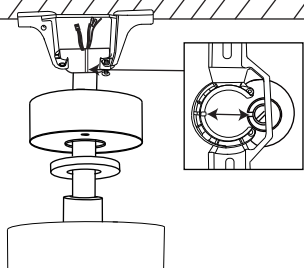

8

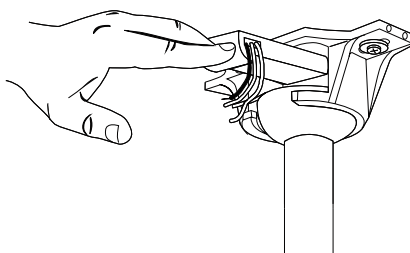

- Hang the downrod onto the bracket, ensuring that the two slots align.
- Place the receiver on the bracket.

9

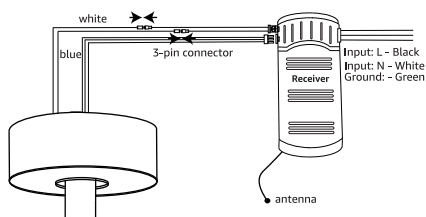

10

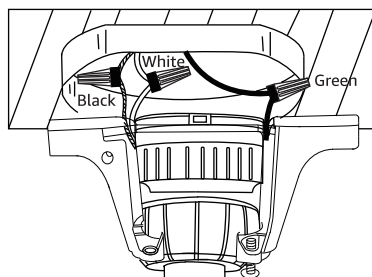

- Connect the wires between the receiver and the fan motor host: connect the blue wires to blue, white to white, and link the 3-pin wires together.
- If there are 4 wires from ceiling, block the red wire(from ceiling) with wire nut and electrical tape.

Wiring:

Connect the "Neutral wire" (white wire) from ceiling to the white wire.

Connect the "Live wire" (black wire) from ceiling to the black wire.

Connect the "Ground wire"

(green or yellow/green or bare) from ceiling to the green wire.

11

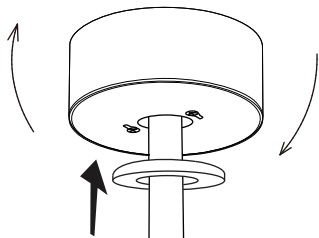

12

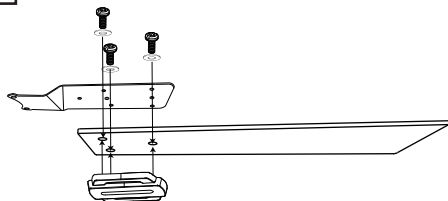

- Push the canopy cover upward, align it with the two screws, rotate and tighten the screws to secure the canopy cover. Then attach the magnetic decor cover to the canopy cover.
- Install the blade decorative part to the blade bottom, then fix with the blade arms with screws and red washers from top. Please note that the side of the blade arms facing up is marked with the word 'UP'.

Installation

13

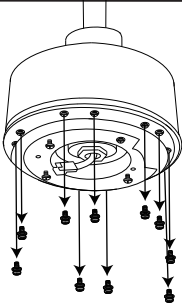

14

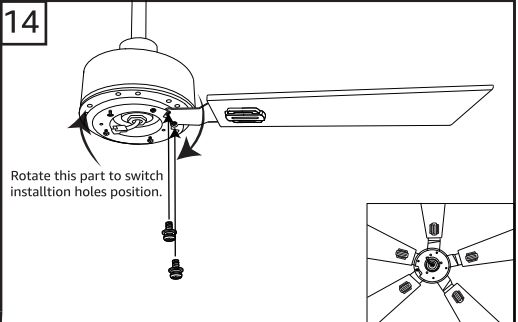

- Remove the 10 host-arm screws pre-installed on the bottom of the fan motor host chassis.
- Align the holes of the blade arm and motor housing, and secure them with the screws removed in the previous step. (Repeat this process to install the remaining blade arms.)

15

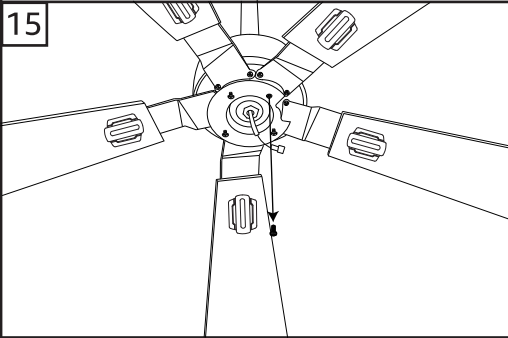

16

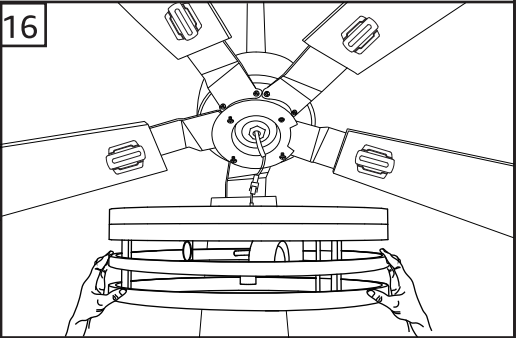

- Take down 1 screw from the round plate.
- Connect the wires from the light fixture to the fan motor host.

17

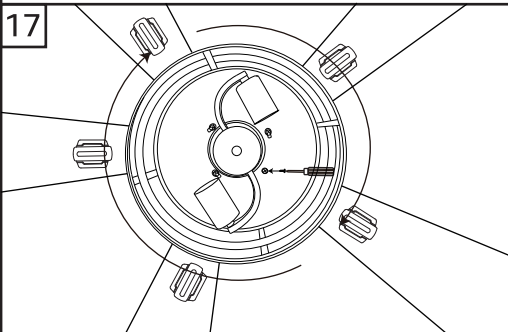

18

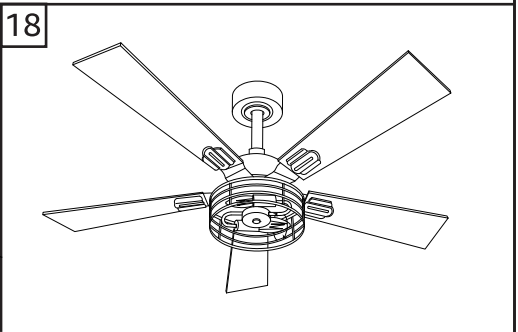

- Put the light fixture upward and then align the holes, rotate the light fixture and then fix with the screw from step#15.
- Screw 2 light bulbs (Bulbs not included)
Recommendation: 120V/60Hz, E12, 10 watt max.

Operate Your Ceiling Fan

IMPORTANT: Using a full range dimmer switch to control fan speed will damage the fan. To reduce the risk of fire or electrical shock, do not use a full range dimmer switch to control the fan speed. (Figure 1).

Only control light on/off via wall fan switch.

Restore electrical power to the outlet box by turning the electricity on at the main fuse box.(Figure 2).

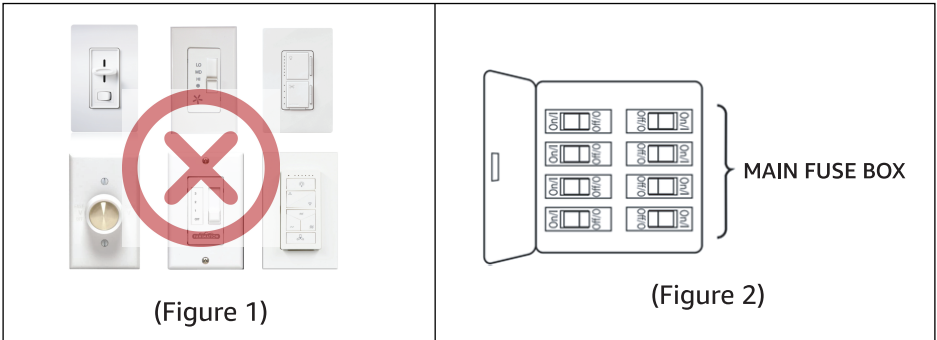

Installation Recommended

Room Size:

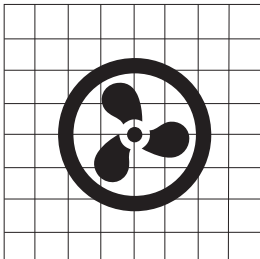





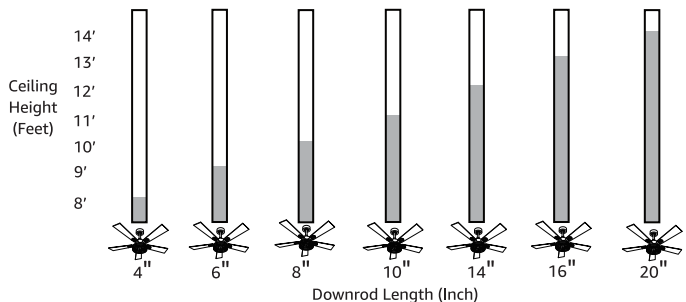



UP TO 10 ft x 10 ft

Recommended Installation Height and downrod length :



Remote Control

	All off
	Light on/off
1-6	Fan speed
	Fan on/off
	Natural wind
	Forward/reverse
	Anti-theft mode (Pressing the button will turn off the light and fan. Then, the light and fan will run for 10 minutes every 4 hours.)
	Delay off in 5 minutes
	Remote controller mute
1H 4H 8H	Fan stops running after 1/4/8 hours

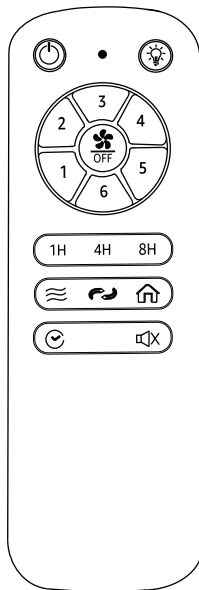

Installing Wall Plate :
Attach wall plate using the two provided screws.

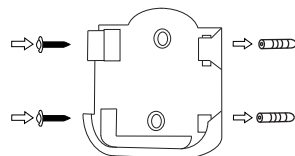

To operate the fan, please install 2 AAA batteries (included) in the handheld remote transmitter. If not used for extended periods of time, remove the batteries to prevent damage to the transmitter. Store the remote away from excessive temperatures and humidity.

Pairing method: (single/multiple fans)

The remote control transmitter can be used to control multiple receivers.

1. For the ceiling fan you want to pair, turn the main power switch off for at least 60 seconds.
2. Turn on the main power switch of the ceiling fan, then immediately press and hold  button.
3. Wait for light flashes or emitting a beep, then release the button, pairing completed.

If the pairing process is unsuccessful, repeat above steps.

Troubleshooting

PROBLEM	SUGGESTED REMEDY
If Fan Does Not Start	<ol style="list-style-type: none"> 1. Check main and branch circuit fuses or circuit breakers. 2. Make sure that the wall control is turned "ON" 3. Check line wire connections to fan and switch wire connections in switch housing. CAUTION: Make sure main power is turned off. 4. Make sure battery has power, change battery(2*AAA) to try again. 5. The remote controller is not paired, check Page.9 to pair. 6. The motor or receiver or remote controller is fault, contact our customer service.
If Fan Sounds Noisy	<ol style="list-style-type: none"> 1. Make sure all screws in motor housing are snug. (not over tightened) 2. Make sure the screws which attach the fan blade bracket to the motor are tight. 3. Make sure the blade is correct installed, "UP" side up. 4. Too close to the wall, make sure the blades at least 3ft to the wall. 5. Make sure wire connectors in switch housing are not rattling against each other or against the interior wall of the switch housing. CAUTION: Make sure main power is turned off before entering switch housing. 6. If using an optional ceiling fan lightkit, make sure the screws securing the lampshade tight. 7. Some fan motors are sensitive to signals from Solid State variable speed controls. DO NOT USE a Solid State variable speed control. 8. Allow "break-in" period of 24 hours. Most noises associated with a new fan will disappear after this period.
If Fan Wobbles	<p>All blades are weighed and grouped by weight. The following procedures should eliminate most of the wobble. Check for wobble after each step.</p> <ol style="list-style-type: none"> 1. Check that all blades are screwed firmly into motor housing. 2. Make sure that canopy and mounting bracket are tightened securely to ceiling junction box and junction box is mounted firmly to ceiling joist. 3. Make sure the ball head into the slot.

Troubleshooting

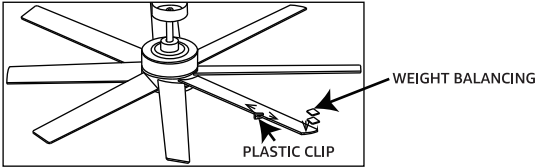
PROBLEM	SUGGESTED REMEDY
<p>If Fan Wobbles</p>	<p>4. Make sure the the downrod is well fixed by screws 5. Interchanging two adjacent blades could redistribute the weight and possibly result in smoother operation. 6. The balancing kit should only be used if there is an unacceptable amount of fan wobble after completing all the steps: <u>How to use balancing kit:</u></p> <p>(1) Turn the fan on and set the speed control setting to a speed at which the wobble is the greatest. (2) Turn off the fan and allow it to come to a complete stop. Select one blade and place the balance clip on it, halfway between the blade holder and the blade tip on the trailing edge of the blade. (3) Turn the fan on. Note whether the wobble has increased or decreased. Turn the fan off, move the clip to another blade, and retest. Repeat this procedure on all blades, noting the blade on which the greatest improvement is achieved. (4) Move the clip back to the blade that showed the greatest improvement. Move the clip inward and outward on this blade and operate the fan to find the position where the clip gives the greatest improvement. (5) Remove the clip and install a balancing weight to the top of the blade along the centerline, near the point where the clip was positioned. (6) If the fan wobble problem has not been corrected, you can try to improve the balancing further by using the balancing clip and additional weights.</p>  <p>The diagram shows a top-down view of a ceiling fan with five blades. One blade is highlighted with a small arrow pointing to a 'PLASTIC CLIP' attached to its trailing edge. Another arrow points to a specific location on the top of the same blade, labeled 'WEIGHT BALANCING'.</p>
<p>If Light Does Not Work or Flickering</p>	<p>1. Check for loose or disconnected wires in fan switch housing. 2. Check the wiring of receiver to the light kit. 3. Check for loose or disconnected wires in light kit, make sure connector is correct inserted. 4. Check for faulty light bulbs. (light bulb version only) 5. There is too many ceiling fans with different control system in the same area, shut down other ceiling fansto check if still flickering. CAUTION: Make sure main circuit is turned off before entering switch housing.</p>

Customer Service

30-Days Full Refund Guarantee

If you are not completely satisfied or the item isn't what you expected, just tell us within 30 days. We will give you a full refund unconditionally.

Friendly Reminder

It's better to contact us than leaving a negative shopping experience. Nothing is more important than your satisfaction, and we will do our best to serve you.

Quick Response within 12 Hours

You can contact us without any hesitation at any time of the day, and we will reply to you within 12 hours. (It would be appreciated if you could provide us with a video or pictures, if available)

2-year Warranty

Your fan light comes with a two-year warranty. If a malfunction occurs due to product quality issues, we will assist in diagnosing the problem and provide replacement parts free of charge to ensure your fan light resumes normal operation.

Replace The Downrod

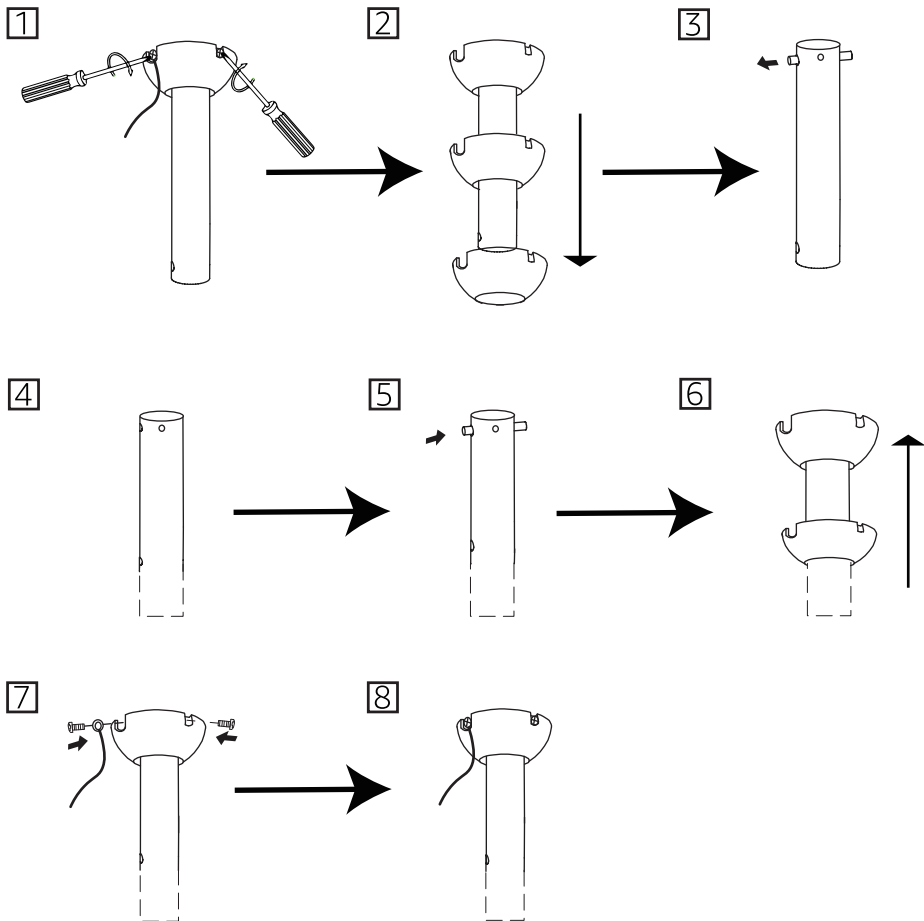

! WARNING

Fan fall hazard

To prevent serious injury or death:

- Always follow the downrod assembly instructions exactly.
- Verify the downrod is assembled correctly by firmly pulling on the hanger ball.
- Pin must be reinserted to secure downrod assembly.

