

B E R N H A R D T





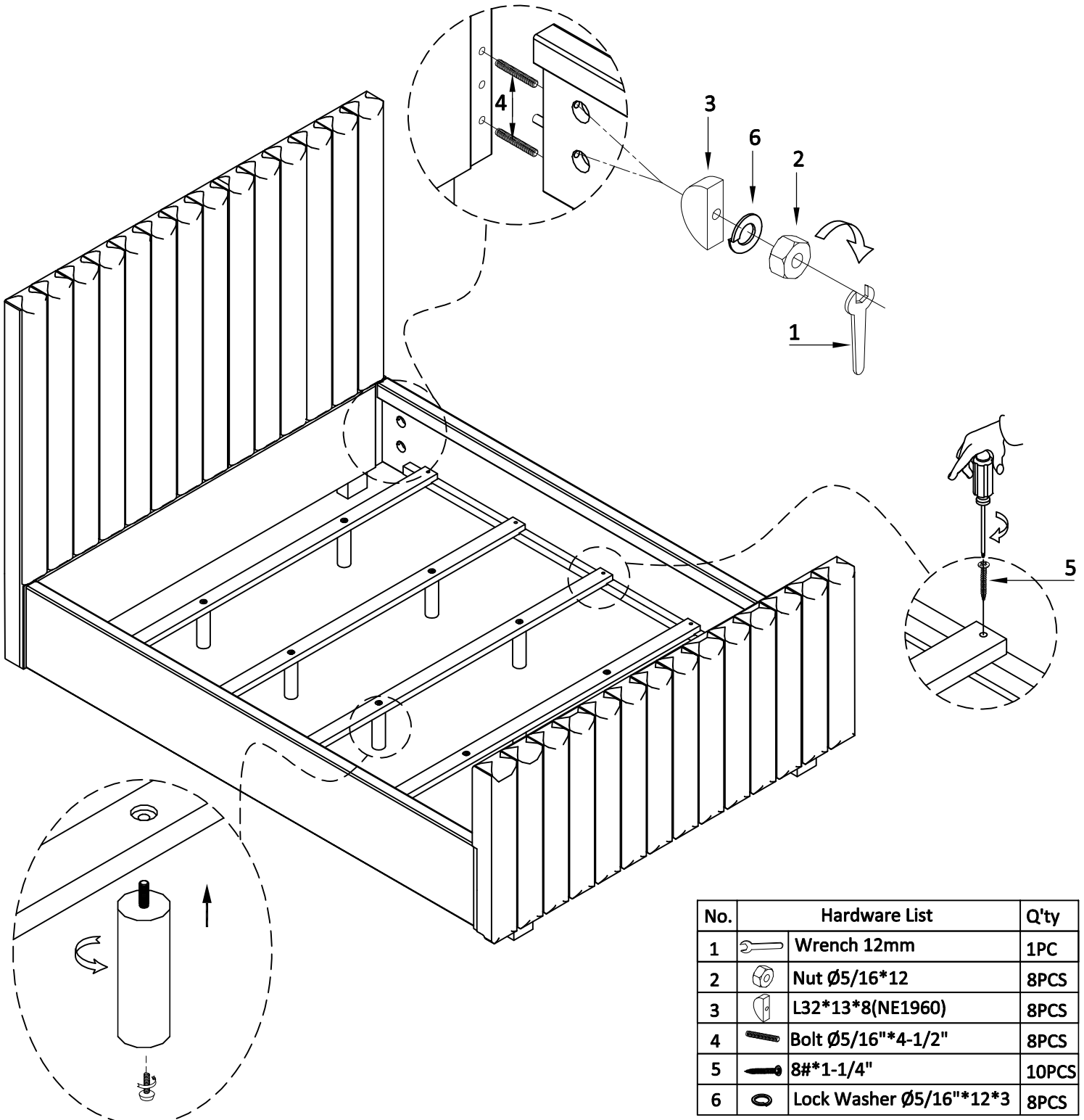

Assembly Instructions

6/6 HEADBOARD
6/6 FTBD/RAILS

Model#: 307-H03
Model#: 307-FR03

Thank you for purchasing Bernhardt furniture. Please check all packing material to ensure proper assembly. Please read all instructions carefully before starting the assembly process. Some parts are large and heavy and require AT LEAST TWO PEOPLE to assemble, in order to prevent possible injury and/or damage to the piece.



| No. | Hardware List | | Q'ty |
|-----|---|-------------------------|-------|
| 1 |  | Wrench 12mm | 1PC |
| 2 |  | Nut Ø5/16*12 | 8PCS |
| 3 |  | L32*13*8(NE1960) | 8PCS |
| 4 |  | Bolt Ø5/16**4-1/2" | 8PCS |
| 5 |  | 8#*1-1/4" | 10PCS |
| 6 |  | Lock Washer Ø5/16**12*3 | 8PCS |

Cleaning instruction: Wipe surface to be cleaned with damp cotton cloth; dry immediately with soft dry cotton cloth to remove all moisture.