

# Armless Chair

## IMPORTANT NOTE

Read these instructions carefully, and familiarize yourself with each procedure before assembling the furniture. Check that you have all the component parts, and familiarize yourself with each part before proceeding.

Take all the fittings out of the plastic bag and separate them into groups. Ensure you have enough space to lay out all the parts before assembly. To prevent damage to the parts, we recommend that you assemble the unit on a soft, level surface.

#5

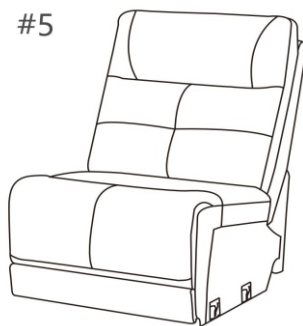

## Part List

A. Back  
1 piece

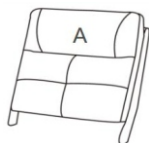

B. Seat  
1 piece

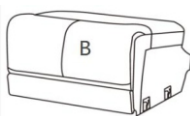

## Assembly Instructions

### STEP 1

Attach the Back (A) to the Seat (B). Ensure the latches fit well. (See Figure 1)

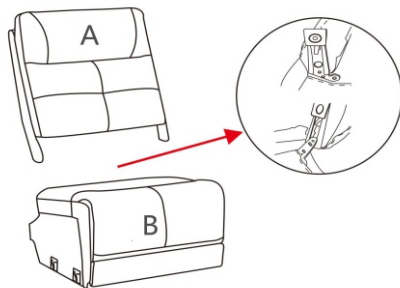

Figure 1

### STEP 2

Begin sectional connection by placing the piece #1 in desired location in the room.

Then start sectional connection by placing piece #2 into piece #1.

Continue sectional connection with piece #3 thru piece #6 following the same method described above.

(See Figure 2)

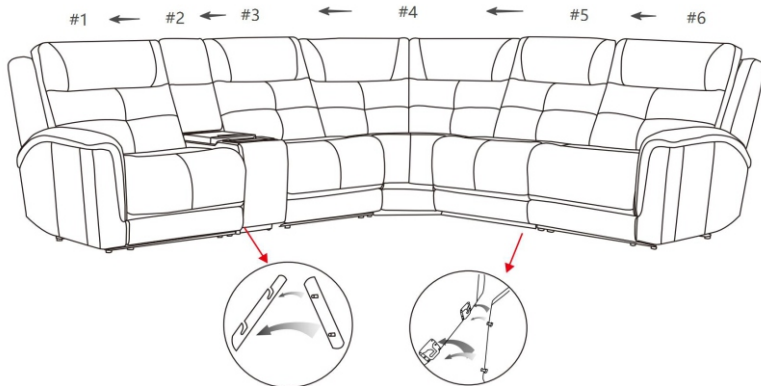

Figure 2

### STEP 3

Connect the transformers into the power port on the back of the piece #1, #2, #3 and #6, then plug them into nearby outlets. (See Figure 3)

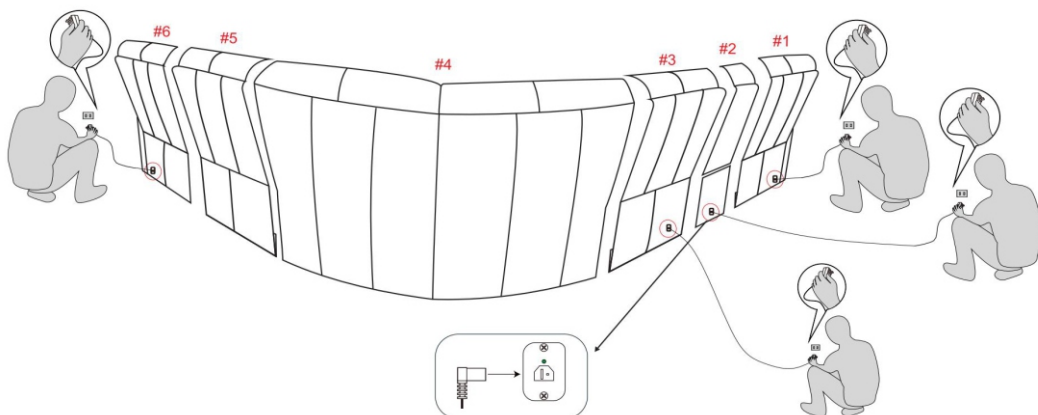

Figure 3

### STEP 4

Fasten all back flaps to the bottom of the furniture. (See Figure 4)

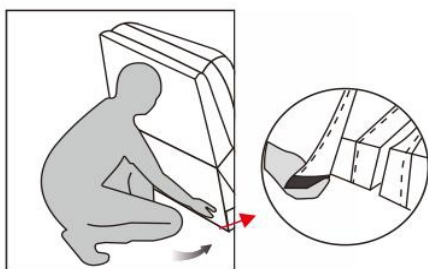

Figure 4

### Disassembly Instructions

Pull up the spring leaf in bracket, then lift Back (A) up. (See Figure 5)

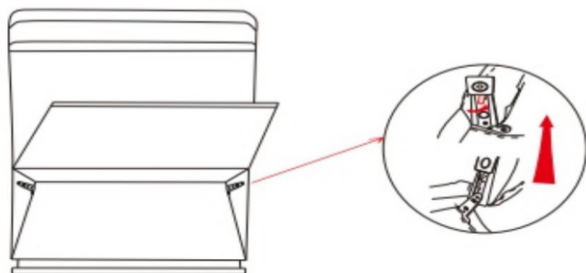

Figure 5

### IMPORTANT NOTE

- To avoid any risk of suffocation to children or pets, dispose of all plastic bags immediately.
- To ensure proper performance, occasionally check for loose screws and tighten as needed.
- If the reclining functions are not working properly, check for loose cable connections before contacting the retailer.