

MANUAL INSTRUCTION

Metal Garden Shed
G37012

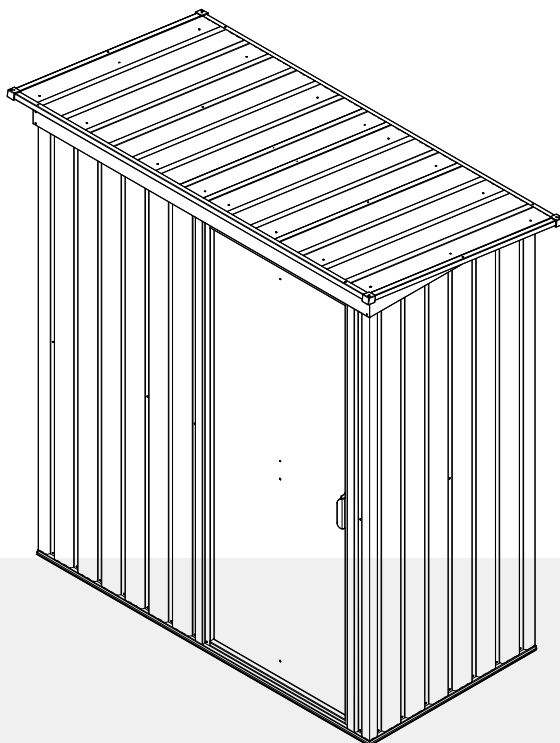

Outdoor Furniture

We are a professional furniture provider with top-notch factories and outstanding designs, Our mission is to provide consumers with new lifestyles. By collecting consumer feedback, we constantly improve our products and create more choices for consumers. If you want to create your space, We are an ideal choice.

Always.



WARNING

All the Bookshelves have passed strict quality inspections before delivery . Read this manual carefully to ensure proper usage

Ensure that all parts and hardware are available before beginning assembly

BEFORE YOU START

Owner's Manual

Prior to installation, it is important that you contact your local government authority to determine if building approval is required. Study and understand this owner's manual. Important information and helpful tips will make your construction easier and more enjoyable.

Assembly instructions

Instructions are supplied in this manual and contain all appropriate information for your building model. Review all instructions before you begin. During assembly, follow the step sequence carefully for correct results.

Parts

Check to be sure that you have all the necessary parts for the building.

Separate contents of the carton by the part number while reviewing parts list.

Familiarize yourself with the hardware and fasteners for easier use during construction. These are packaged within the carton. Note that extra fasteners have been supplied for your convenience.

TOOLS MAY REQUIRED

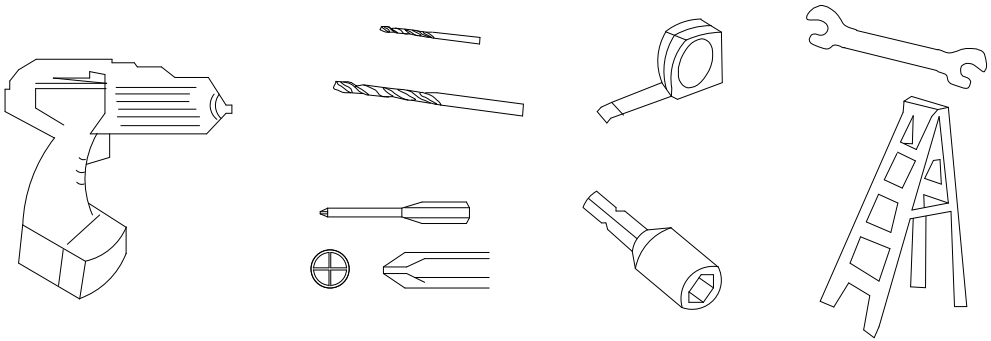

Use heavy duty gloves when handling steel sheets and flashing

PLAN AHEAD

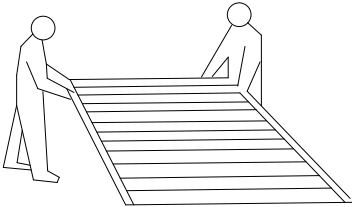

Watch the weather :

Please be sure the day you select for installation is dry and calm.

DO NOT attempt to assemble your shed in windy weather

because of risk of damage to panels, or personal injury. Be care of wet or muddy ground.

Teamwork :

Whenever possible, two or more people should work together to assemble the building. One person can position parts or panels while the other is able to handle the fasteners and the tools.

PLAN AHEAD

Site Selection

- Avoid overhanging trees as much as possible as leaves will make regular cleaning necessary and broken branches are a potential hazard.
- Small trees, bushes or fences nearby can be helpful, acting as a wind break.

Site Preparation

The site must be prepared so that the base of the shed is level all round and checking with a spirit level is required.

The base can be constructed by treated timber or concrete, in order to stop the moisture getting into the shed. **The shed is not designed to be built onto lawn directly.** Also the ground will get muddy during rainy days.

If a concrete pad is made, it is important that this slopes towards the edges to prevent water ingress.

Time must be allowed for any concrete or cement to dry before building the shed on top.

Bases can also be constructed from bricks, blocks, or mounted on a concrete.

The bricks/blocks should be cemented onto a level concrete footing and greenhouse frame drilled and screwed to the base.

IMPORTANT NOTES

- Find someone to help you: it is much easier with someone to hold parts, pass tools etc. Also some steps require two people to lift structures together. This is not very heavy work so would suit most able-bodied people.

Allow plenty of time: rushing often causes errors and the re-doing of incorrect assemblies. If you have never

- built a shed before, it can take most of a day to carefully complete the construction.
- Have the right tools to hand.
- Safety clothing as recommended in the 'tools' section.
- Ideally lay out the parts and check that all are present before commencing construction. Lay on cloths or plastic sheets if there is any risk of scratching the parts.
- Tighten all nuts carefully, being sure not to miss any. Check the frame is square and using a spirit level to check that it is upright.

I PARTS LIST



2 Persons Assembly



Up to 30 Minutes For Assembly

PARTS

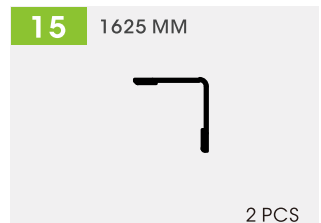
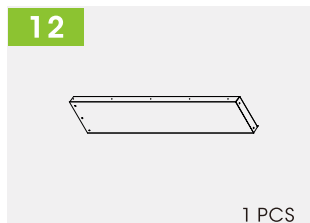
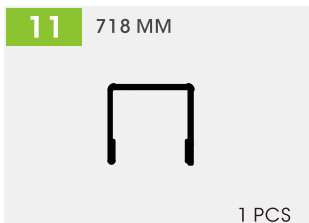
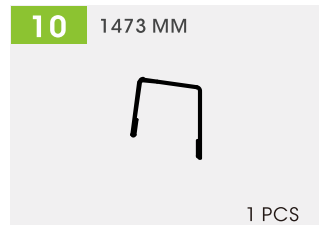
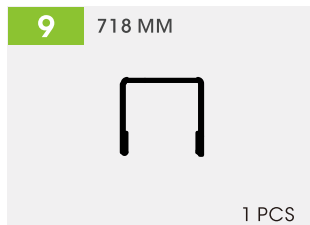
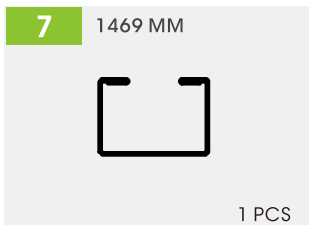
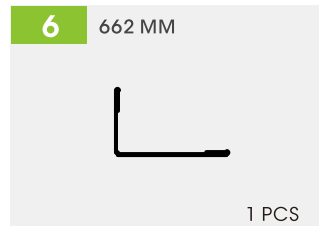
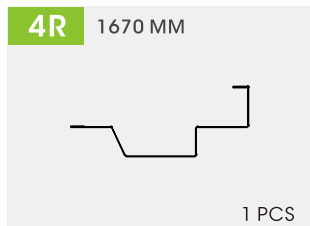
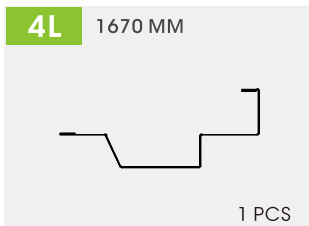
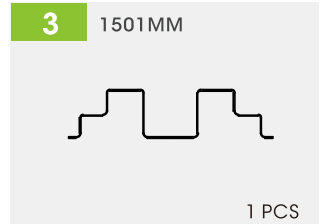
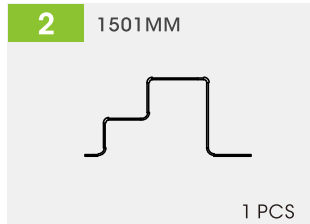
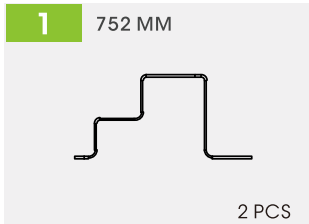

17

868 MM



2 PCS

21L



1 PCS

21R



1 PCS

D1

1660X328 MM



1 PCS

D2

1660X328 MM



1 PCS

D3

1660 MM



2 PCS

D4

650 MM

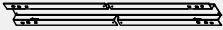

3 PCS

P3

1670 MM



4 PCS

P4

1670 MM



4 PCS

P5

868 MM



2 PCS

P6

868 MM



2 PCS

P12

1670 MM

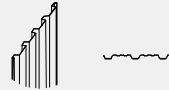

1 PCS

P13

1670 MM

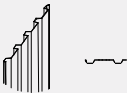

1 PCS

HARDWARE

F1

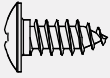

146 PCS

F2



25 PCS

F3

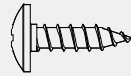

4 PCS

G2



2 PCS

GB

M4 X 16MM

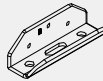

1 PCS

GB1

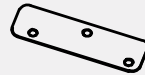

1 PCS

GC

M4



4 PC

GD

M6 X 30MM



2 PCS

S3



151 PCS



2PCS



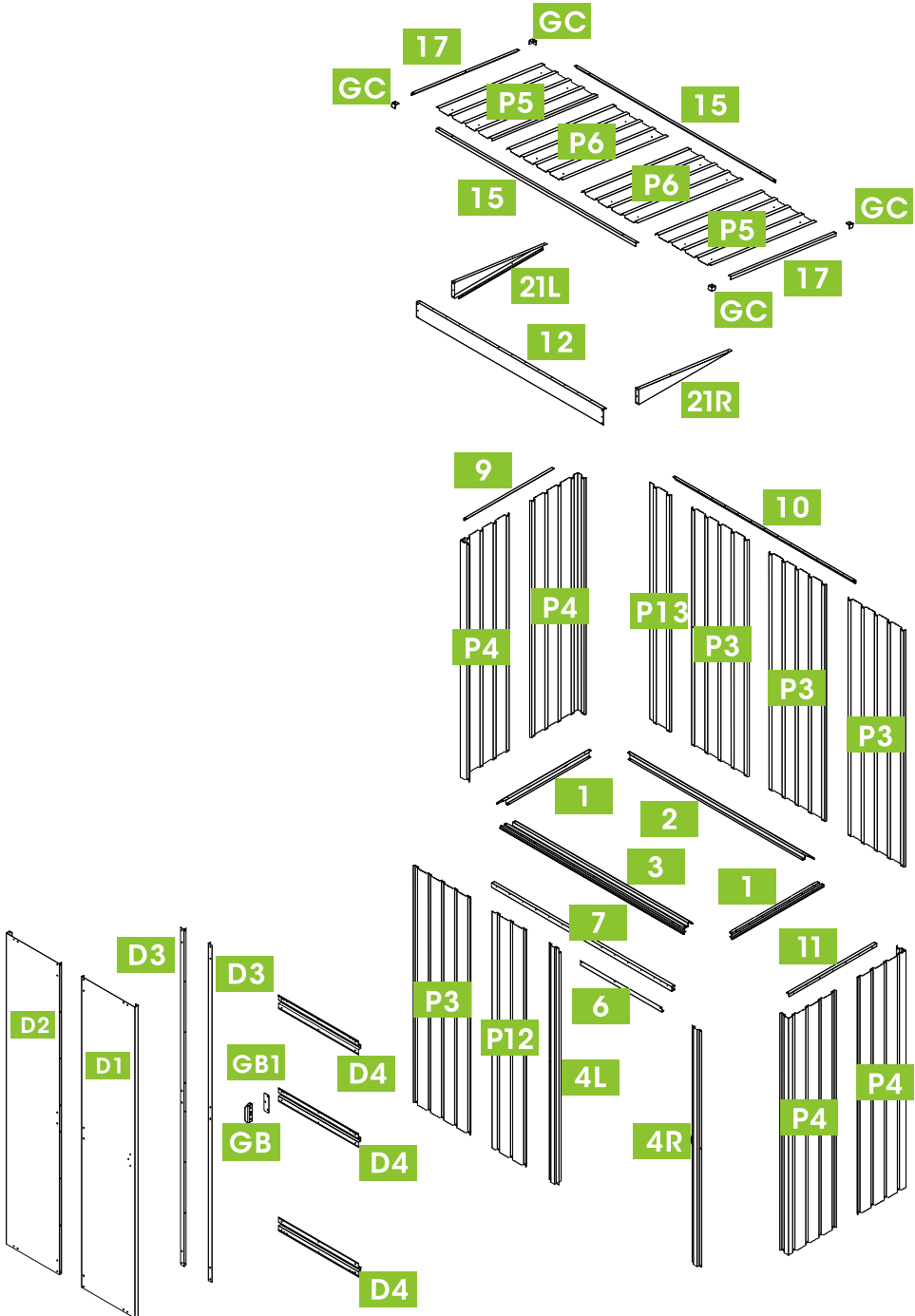

PRODUCT ASSEMBLY

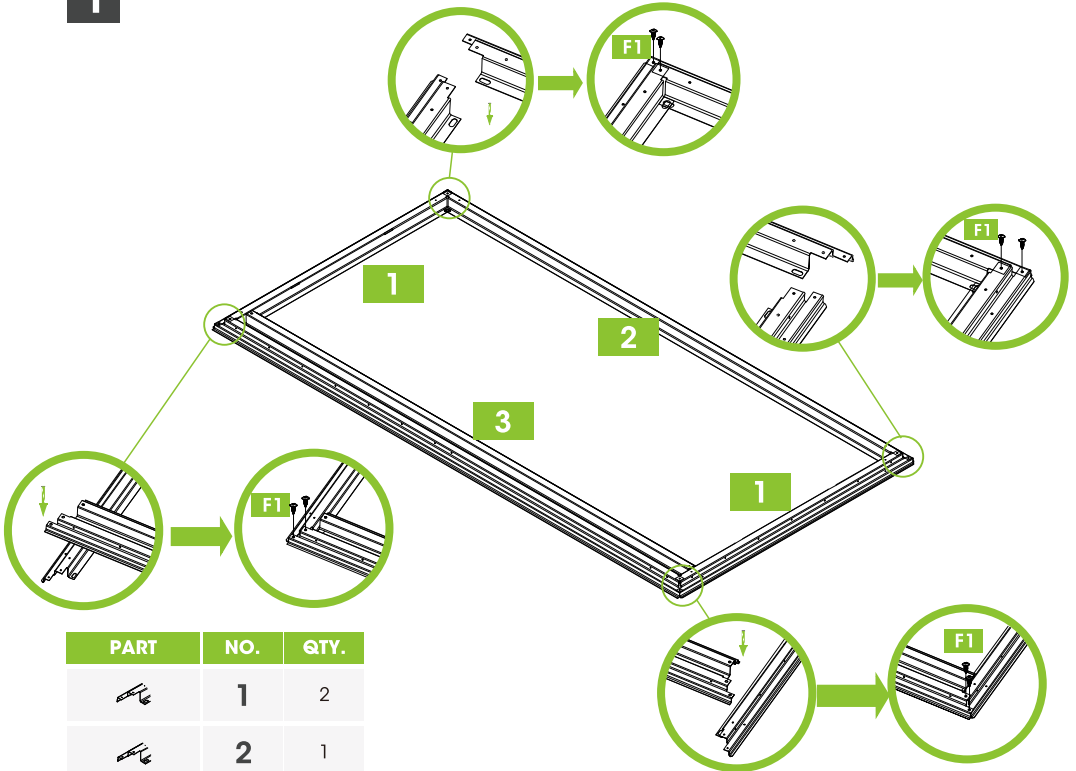

PRODUCT ASSEMBLY Method A

1



PART	NO.	QTY.
	1	2
	2	1
	3	1
	F1	8

1. When diagonal measurements are equal, the frame is square.

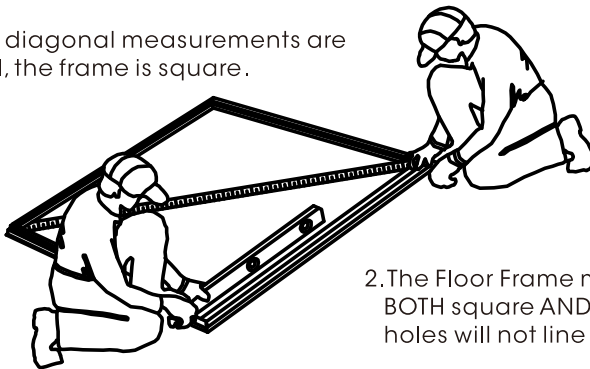





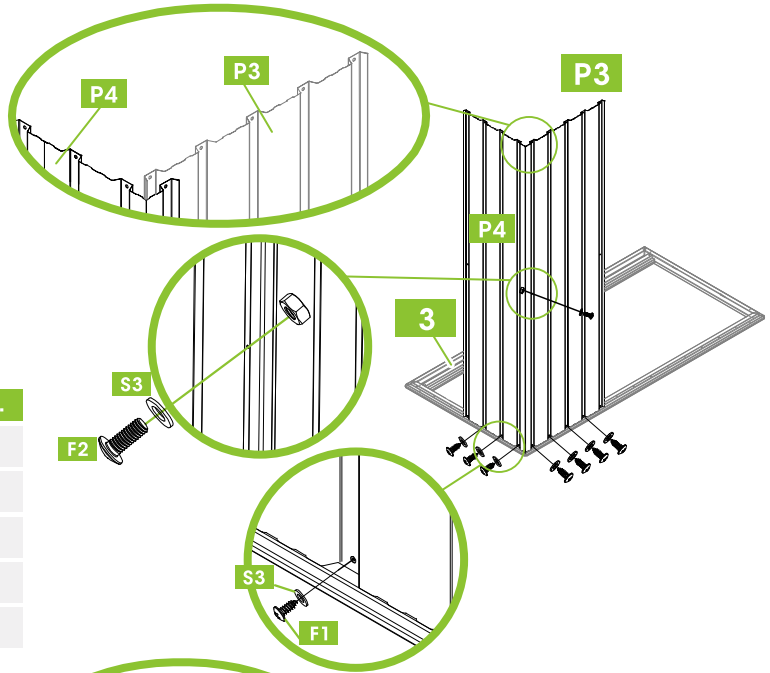

2. The Floor Frame must be BOTH square AND level or the holes will not line up properly.

PRODUCT ASSEMBLY Method A

2





⚠ Please note the position with number 3 and do not install it upside down

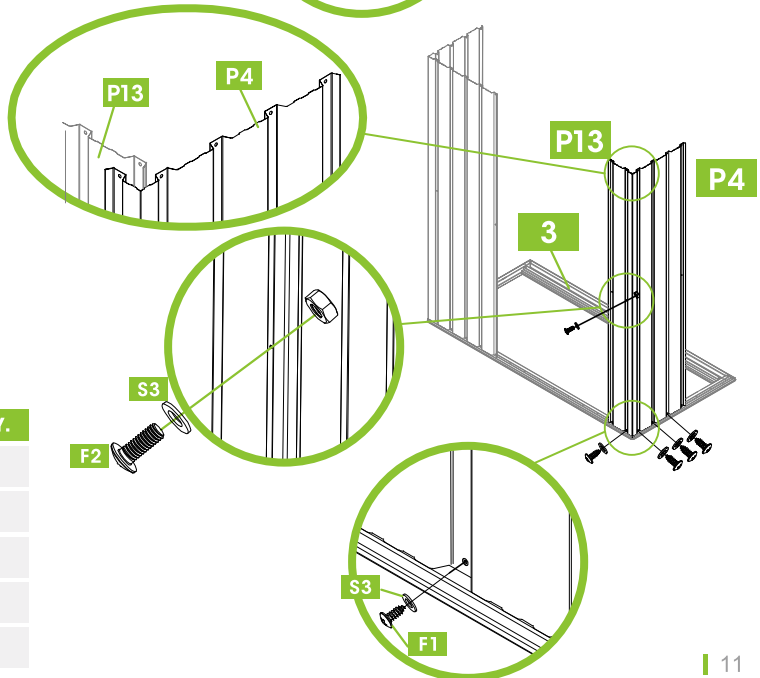

PART	NO.	QTY.
	P4	1
	P3	1
	F1	7
	F2	1
	S3	8

3







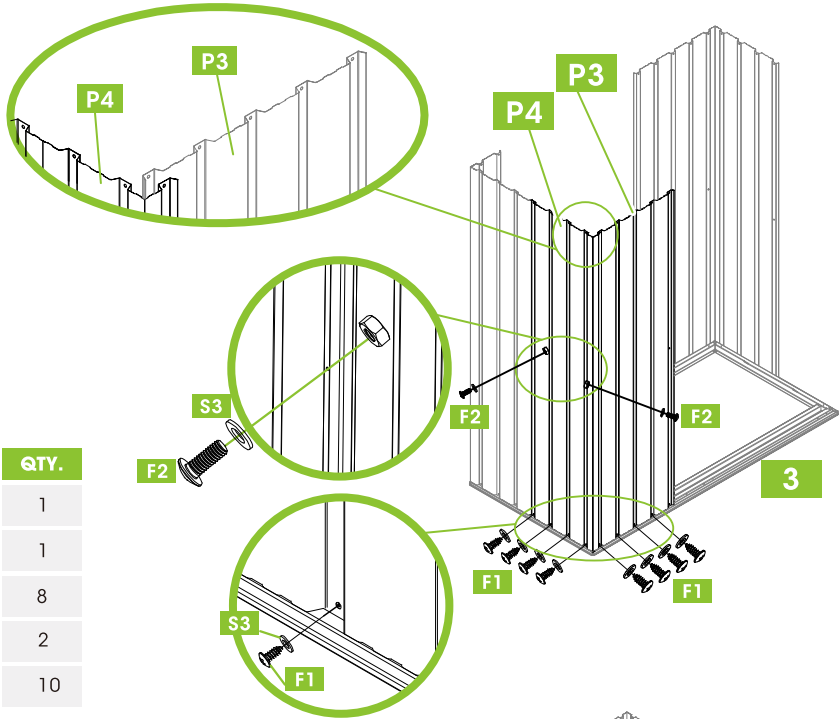

PART	NO.	QTY.
	P4	1
	P13	1
	F1	4
	F2	1
	S3	5

PRODUCT ASSEMBLY Method A

4





⚠ Please note the position with number 3 and do not install it upside down

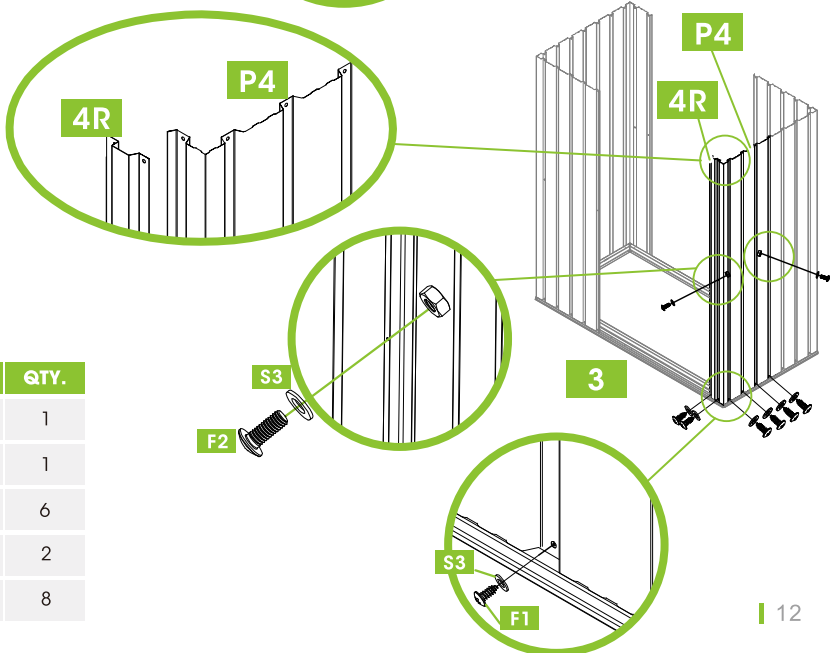

PART	NO.	QTY.
	P4	1
	P3	1
	F1	8
	F2	2
	S3	10

5



PART	NO.	QTY.
	P4	1
	4R	1
	F1	6
	F2	2
	S3	8

PRODUCT ASSEMBLY Method A

6

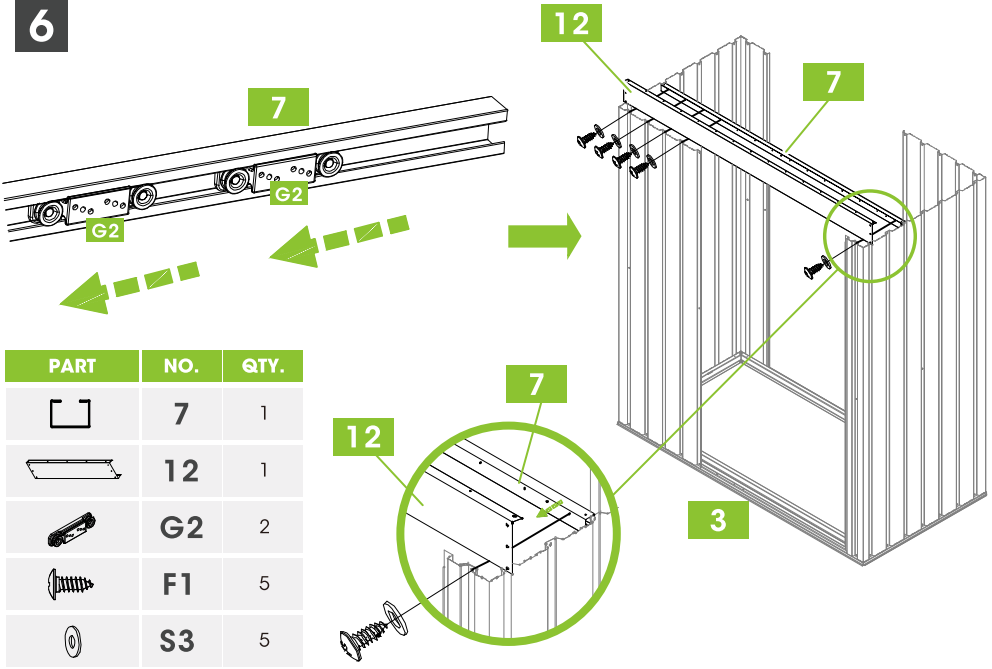

PART	NO.	QTY.
	7	1
	12	1
	G2	2
	F1	5
	S3	5

7

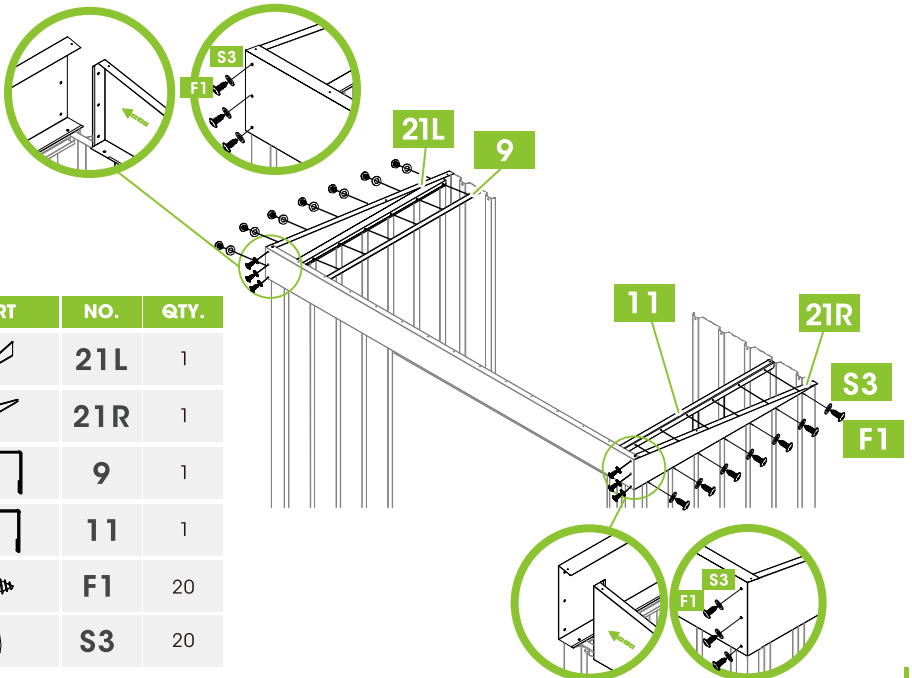

PART	NO.	QTY.
	21L	1
	21R	1
	9	1
	11	1
	F1	20
	S3	20

PRODUCT ASSEMBLY Method A

8

OUTER P12

PART	NO.	QTY.
	P12	1
	4L	1
	6	1
	F1	11
	F2	2
	S3	13





9

PART	NO.	QTY.
	10	1
	P3	2
	F1	27
	F2	3
	S3	30

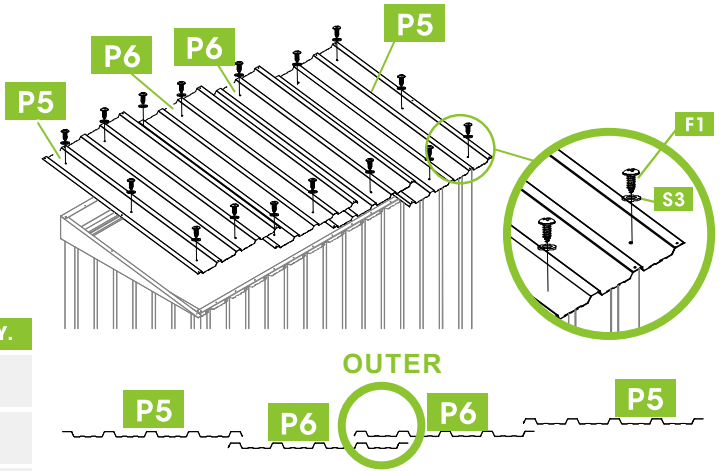
PRODUCT ASSEMBLY Method A





10

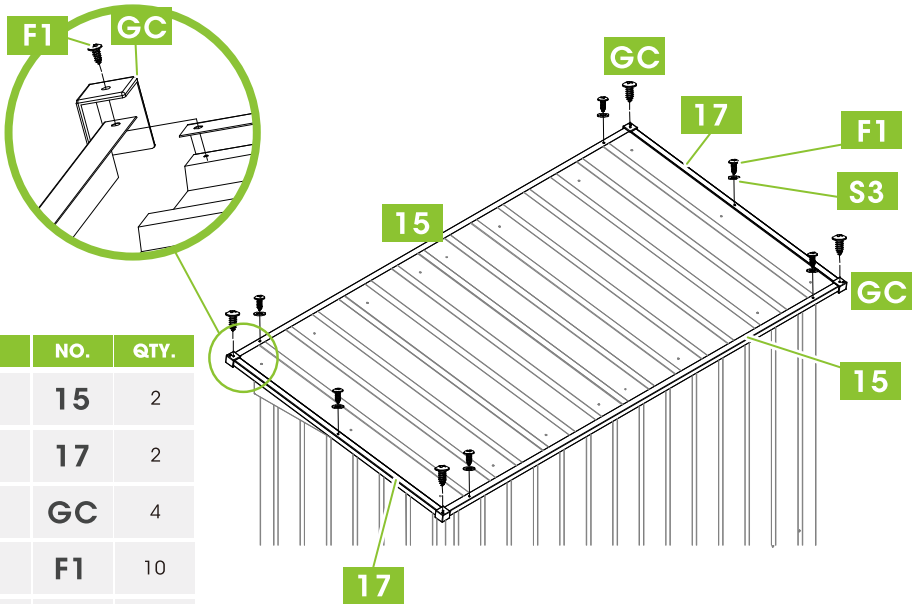

PART	NO.	QTY.
	P5	2
	P6	2
	F1	16
	S3	16

11



PART	NO.	QTY.
	15	2
	17	2
	GC	4
	F1	10
	S3	10

12

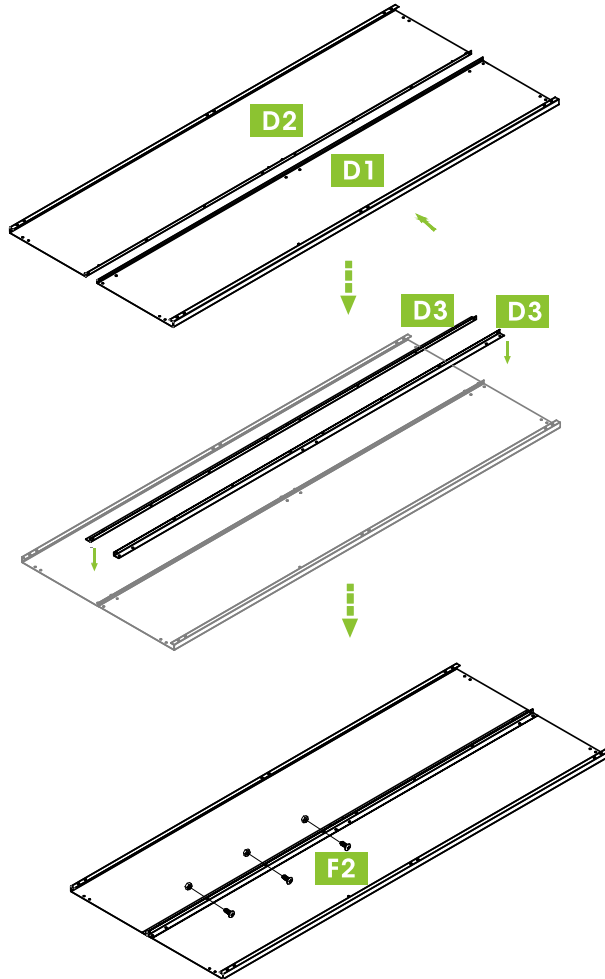



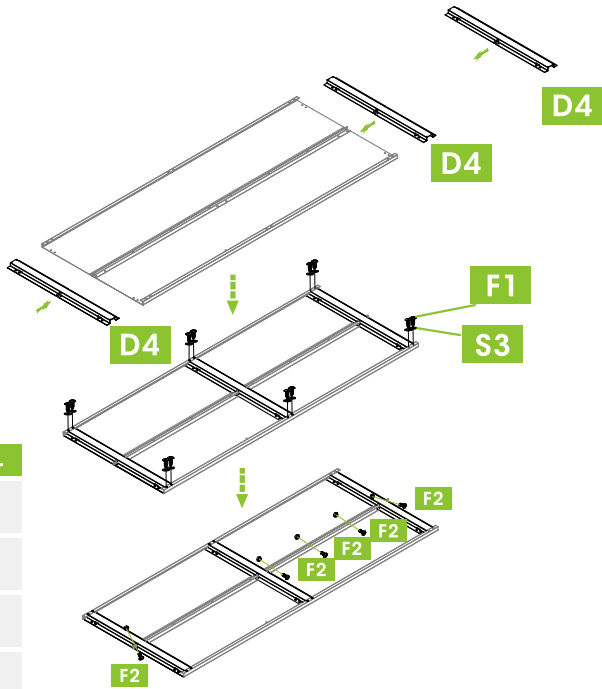

PART	NO.	QTY.
	D1	1
	D2	1
	D3	2
	F2	4

PRODUCT ASSEMBLY Method A





13

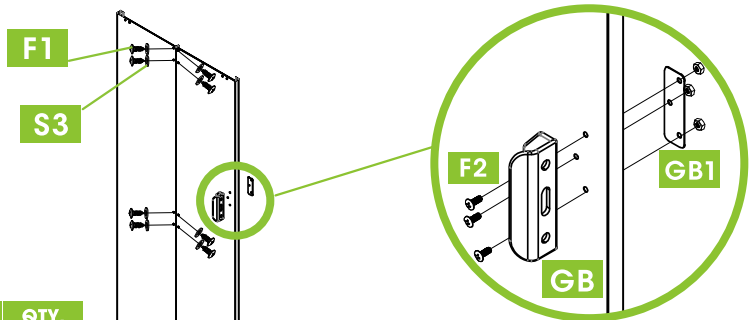

PART	NO.	QTY.
	D4	3
	F1	12
	F2	5
	S3	12

14





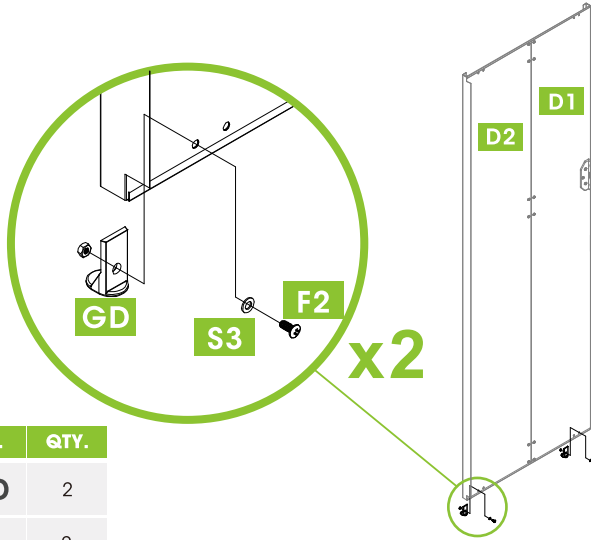

PART	NO.	QTY.
	GB	1
	GB1	1
	F1	12
	F2	3
	S3	12

PRODUCT ASSEMBLY Method A

15



PART	NO.	QTY.
	GD	2
	S3	2
	F3	4
	F2	2

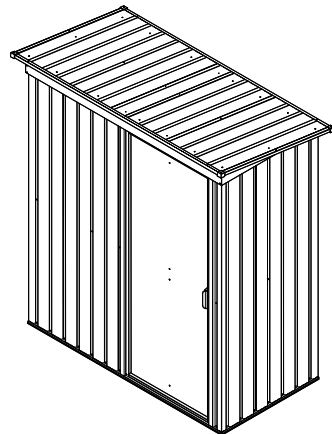
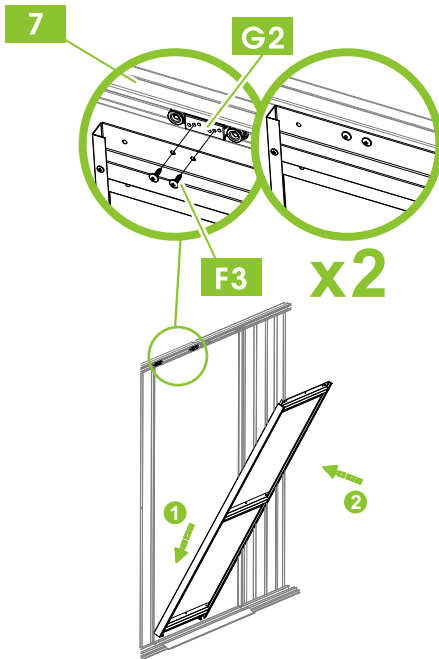

PRODUCT ASSEMBLY



WARNING



Children have died from furniture tipover. To reduce the risk of furniture tipover:

100%

V ALWAYS install tipover restraint provided.

V NEVER put a TV on this product.

V NEVER allow children to stand, climb or hang on drawers, doors, or shelves.

V NEVER open more than one drawer at a time.

V Place heaviest items in the lowest drawers.



HELP CENTER

Question about your product? We're here to help. Visit us at:

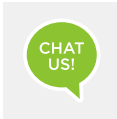

Chat Support



Product Inquiry

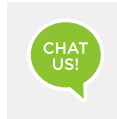

Orders FAQ



Product Assembly



Returns & Refunds

We Stand Behind the Quality of Their Furniture

If you have any issues with your item please let us know! We will always do our best to come up with a solution that you will be happy with.

Please get in touch with our customer service team before returning the product.

And pls do not throw the original box(es) if you have not finished assembling or confirmed no quality issues.

Length of return period:

Items can be returned within 30 days of purchase.

In the meanwhile, everything you purchased from us comes with a one-year warranty.

Who is responsible for the return shipping fee:

We will cover the return shipping fees if:

1. Your item has a manufacturing defect in its materials or workmanship. For example, torn wicker or misaligned screw holes. We will send you a prepaid shipping label after photos are sent.
2. Your item has been damaged in transit. For example, glass is broken or wicker is damaged. We will send you a prepaid shipping label after photos are sent.
3. You receive the wrong box(es) due to a warehouse error. We will send you a prepaid shipping label after photos are sent of the wrong SKU numbers on the outer box(es).
4. One or more boxes are lost in transit. We will send you a prepaid shipping label if you no longer want the item.

*However, we still hope to work with you for a better solution instead of a return. Please don't hesitate to contact our customer service team.

Customer will cover the return shipping fees if:

1. You don't like the product(s) after receiving the box(es).
2. You no longer need the product(s) but you have received the box(es).
3. You buy the product(s) by mistake but you have received the box(es).
4. Order/Shipment cancellation failed and you have received the box(es).

Return Request

In order to get a full refund as described in this return policy, all items must be: (1) In a brand new/unused condition, please provide photos before and after packaging. (2) When returning, all accessories and parts are firmly packed in all original packaging. If your return does not meet the requirements, you may not get a full refund.

When will I be refunded?

The refund is released once the goods have been returned to our warehouse.

What if the product is damaged/defective outside of the valid return period?

We want you to be a happy customer. Please reach out to us by email and we will come up with a solution to make sure you are satisfied.