

Installation & Assembly

"IMPORTANT, RETAIN FOR FUTURE REFERENCE: READ CAREFULLY"





German: WICHTIG, FÜR SPÄTERE NACHSCHLAGE AUFBEWAHREN: SORGFÄLTIG LESEN





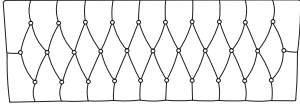



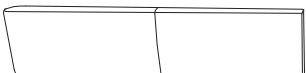









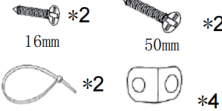

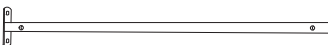
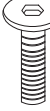
Spanish: IMPORTANTE, GUARDAR PARA REFERENCIA FUTURA: LEER ATENTAMENTE

Italian: IMPORTANTE, CONSERVARE PER RIFERIMENTI FUTURI: LEGGERE ATTENTAMENTE

French: IMPORTANT, À CONSERVER POUR RÉFÉRENCE FUTURE : LIRE ATTENTIVEMENT

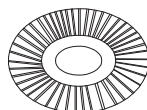
- !** 1. Two or more people are required for assembly.
 2. To avoid squeaking, please tighten the bolts all the way.
 An electric drill is recommended for the assembly.
 3. Professional installation is highly recommended.
1. Für den Zusammenbau werden zwei oder mehr Personen benötigt.
 2. Um Quietschgeräusche zu vermeiden, ziehen Sie die Schrauben bitte ganz fest.
 Die Verwendung einer elektrischen Bohrmaschine wird empfohlen.
 3. Ein fachgerechter Einbau wird dringend empfohlen.
1. Il faut au moins deux personnes pour le montage.
 2. Pour éviter tout grincement, veuillez serrer les boulons à fond. Il est recommandé d'utiliser une perceuse électrique.
 3. Une installation professionnelle est fortement recommandée.
1. E' necessario due o più persone per l'installazione.
 2. Per evitare cigolii, serrare bene i bulloni. Si consiglia di utilizzare un trapano elettrico.
 3. Si consiglia vivamente un'installazione professionale.
1. Se necesitan dos o más personas para el montaje.
 2. Para evitar chirridos, apriete todos los tornillos. Se recomienda utilizar un taladro eléctrico.
 3. Se recomienda encarecidamente la instalación profesional.

Item no. Nr. N° d'article Articolo No. Artículo No.	Reference Image Referenzbild Image de référence Immagine di riferimento Imagen de referencia	Qty. Menge Qté. Qtà Cant.	Item no. Nr. N° d'article Articolo No. Artículo No.	Reference Image Referenzbild Image de référence Immagine di riferimento Imagen de referencia	Qty. Menge Qté. Qtà Cant.
A		X1	D		X1
B		X1	E		X1
C		X1	F		X1

Item no. Nr. N° d'article Articolo No. Artículo No.	Reference Image Referenzbild Image de référence Immagine di riferimento Imagen de referencia	Qty. Menge Qté. Qtà Cant.	Item no. Nr. N° d'article Articolo No. Artículo No.	Reference Image Referenzbild Image de référence Immagine di riferimento Imagen de referencia	Qty. Menge Qté. Qtà Cant.
G		X4	S		X2
H		X4	T		X2
I	 I*16 Ia*8 Ib*4	X1	U		X4
J		X2	V		X20
K		X2	W	 16mm *2 50mm *2 *2 *4	X1
L		X2	X	 M8 X 20MM	X28
M		X2	Y	 M8 X 40MM	X8
N		X2	Z	 M6 X 16MM	X20
O		X1	1		X36
P		X1	2		X4
Q		X5	3	 M8	X1
R		X1	4	 M6	X1

1

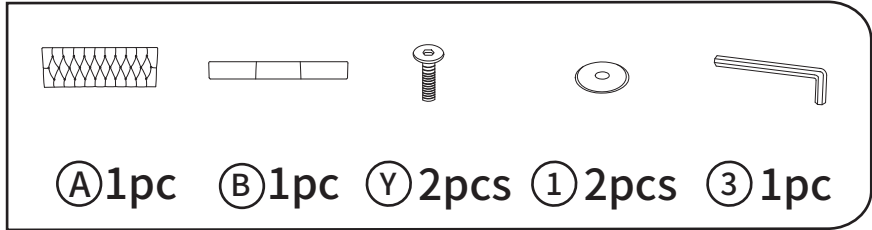

Ⓐ 1pc Ⓑ 1pc Ⓨ 2pcs ① 2pcs ③ 1pc

This block contains a list of parts for step 1. Above the list are five small icons: a mesh grille (A), a long thin bar (B), a screw (Y), a washer (1), and an L-shaped bracket (3).

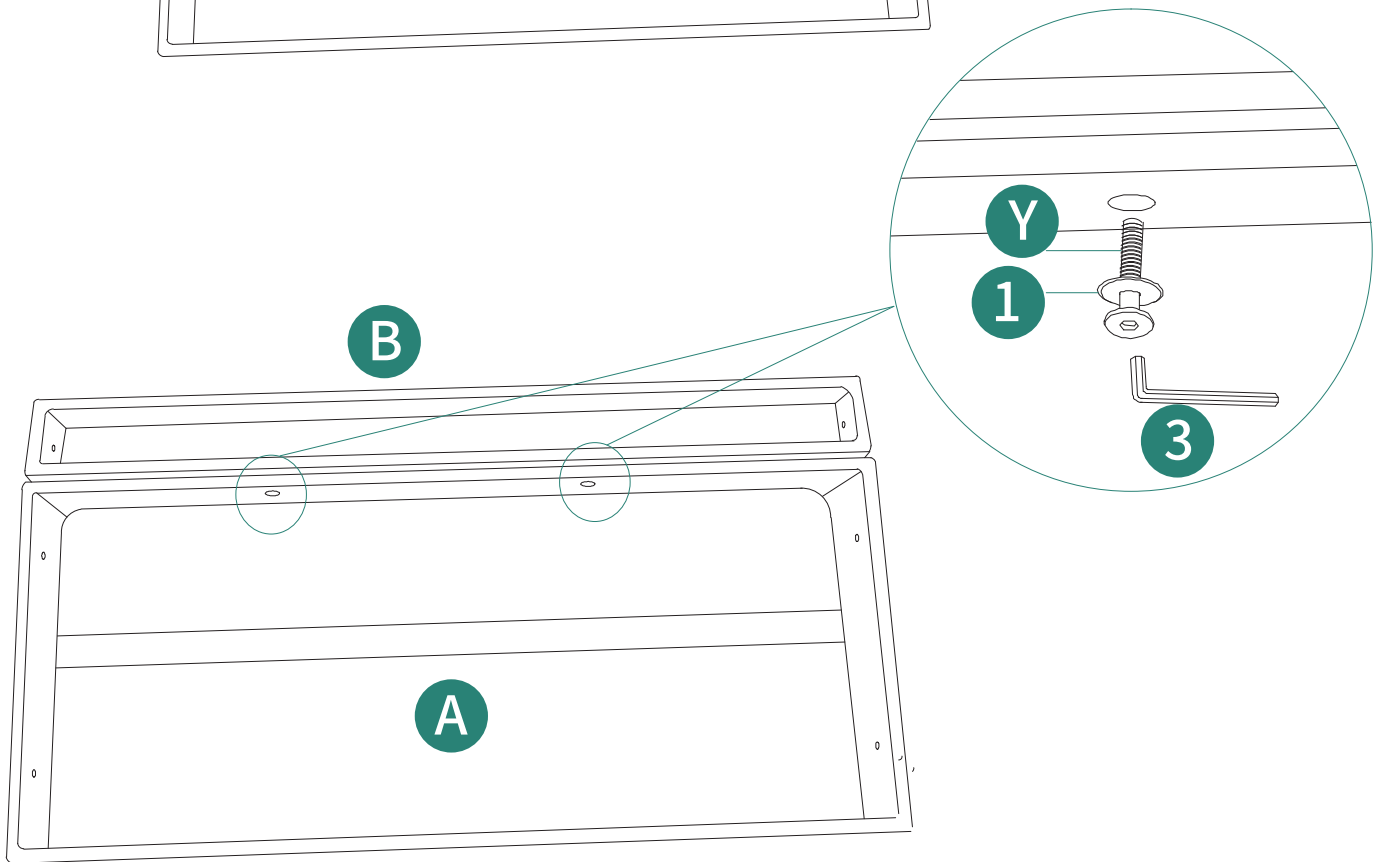
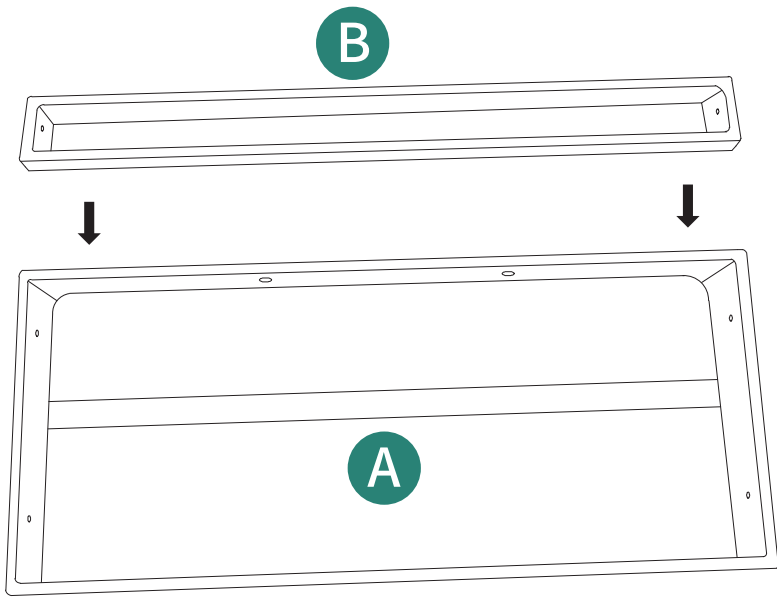

2

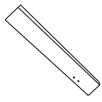

ⓐ 1pc

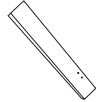

ⓓ 1pc



Ⓨ 2pcs



① 2pcs

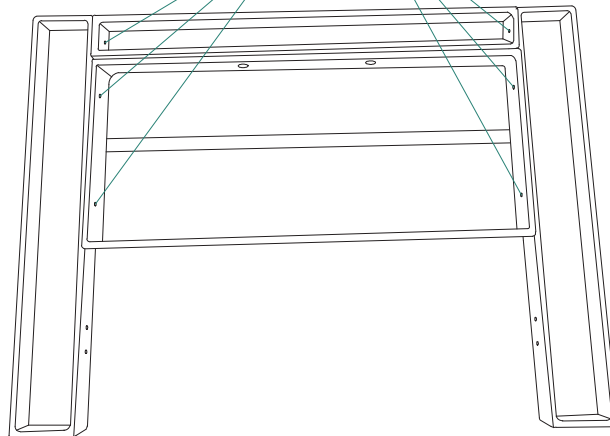
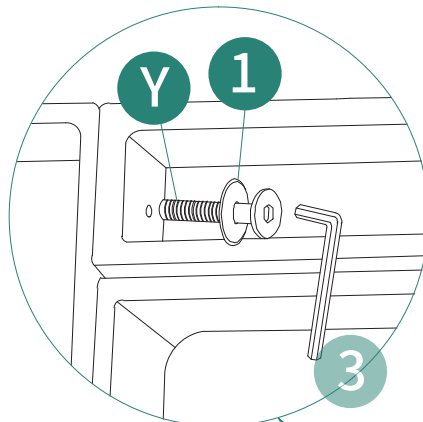
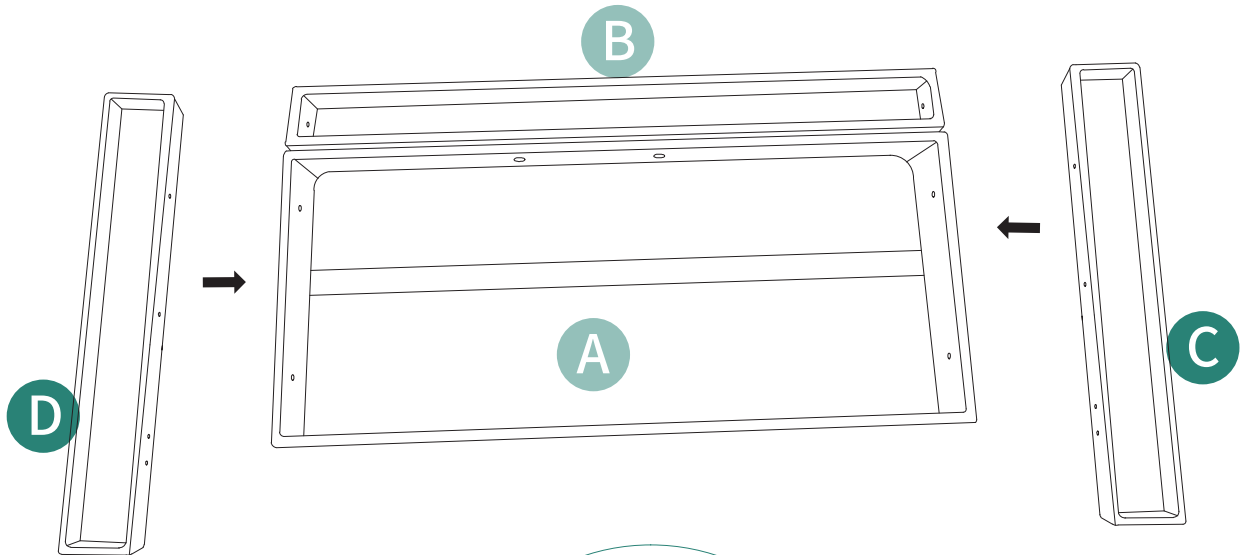





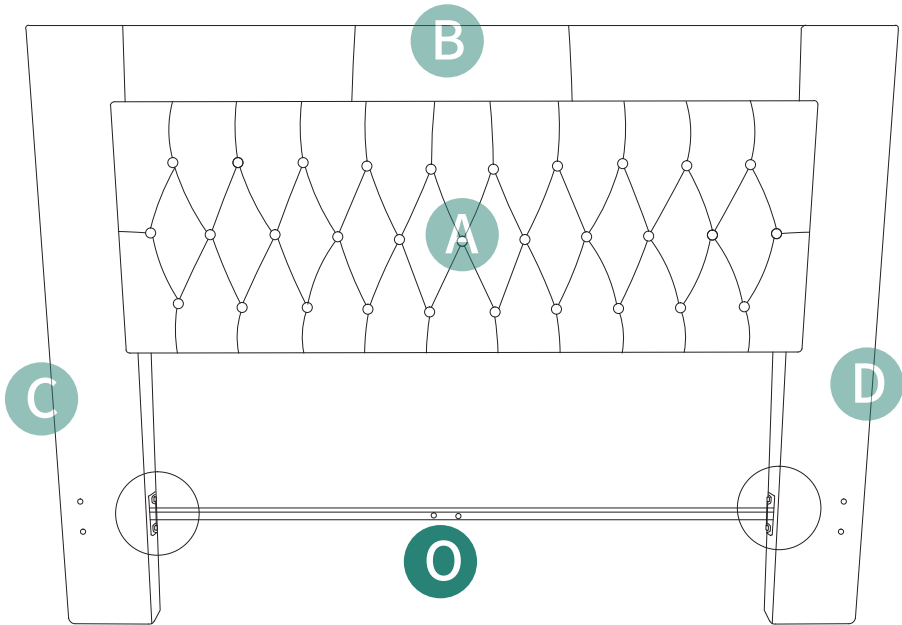
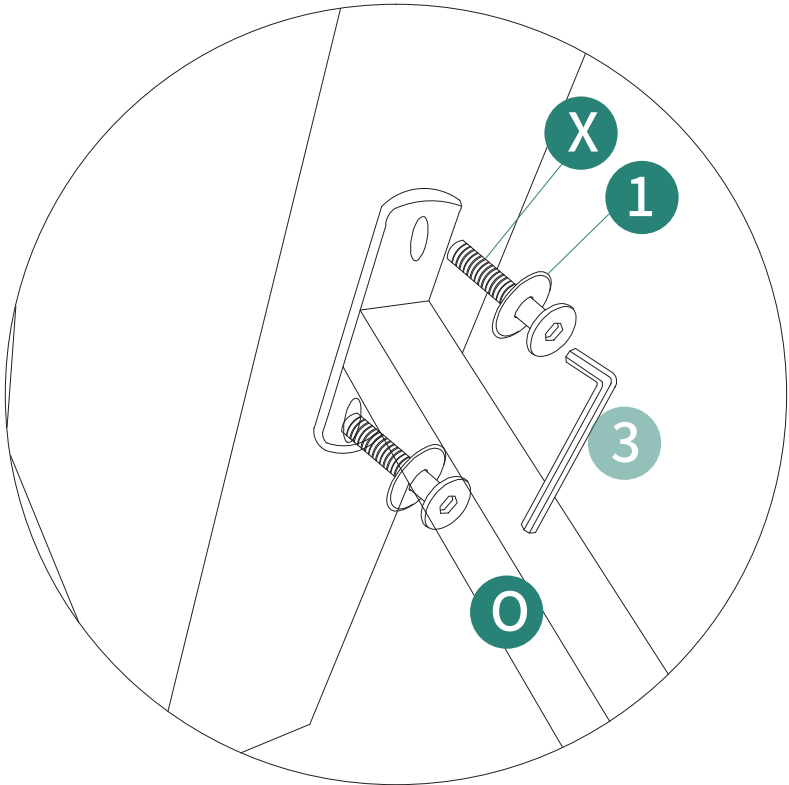

3

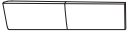
⊙ 1pc ⊗ 4pcs ① 4pcs

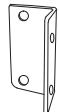

4

-  **E** 1pc
-  **F** 1pc
-  **J** 2pcs
-  **R** 1pc
-  **X** 4pcs
-  **1** 4pcs
-  **2** 4pcs

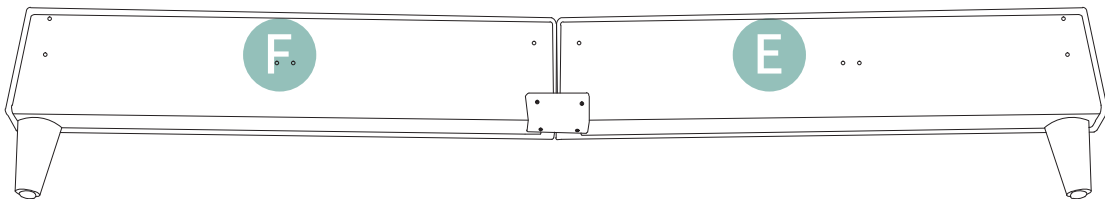
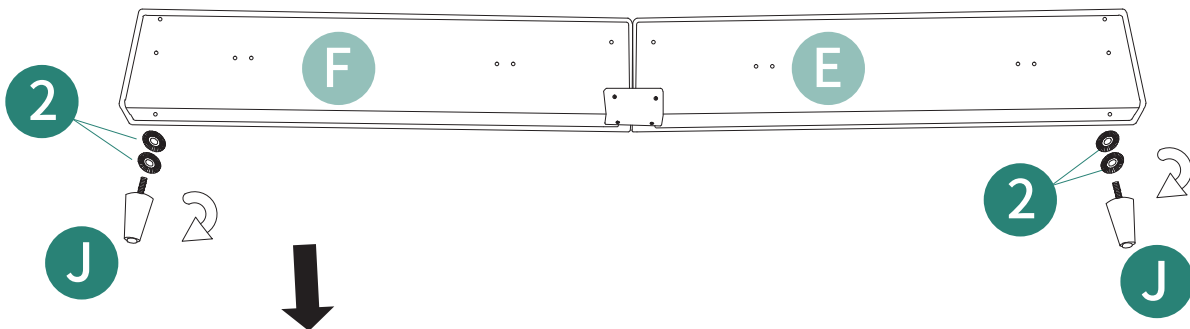
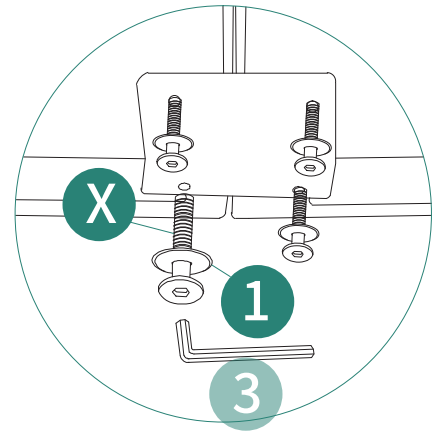
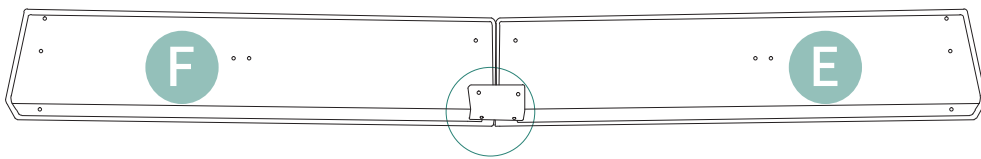
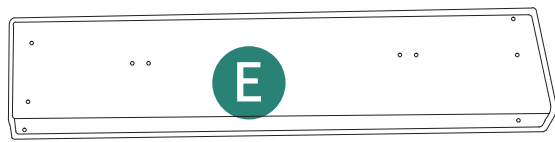

5

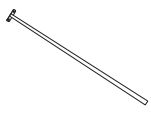

Ⓝ2pcs

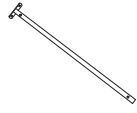

Ⓜ2pcs

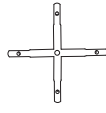

Ⓟ1pc

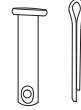

Ⓤ4pcs

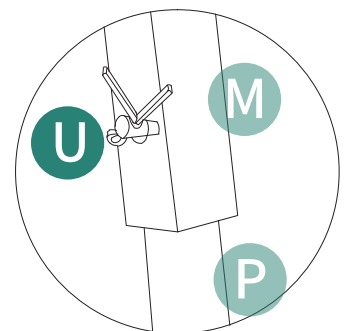
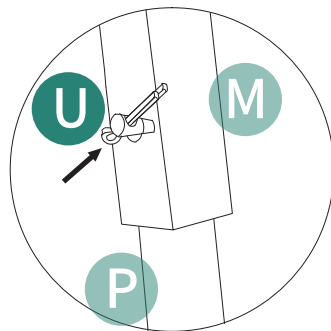
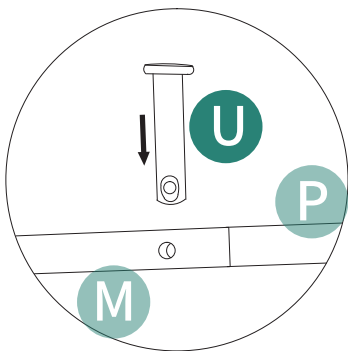
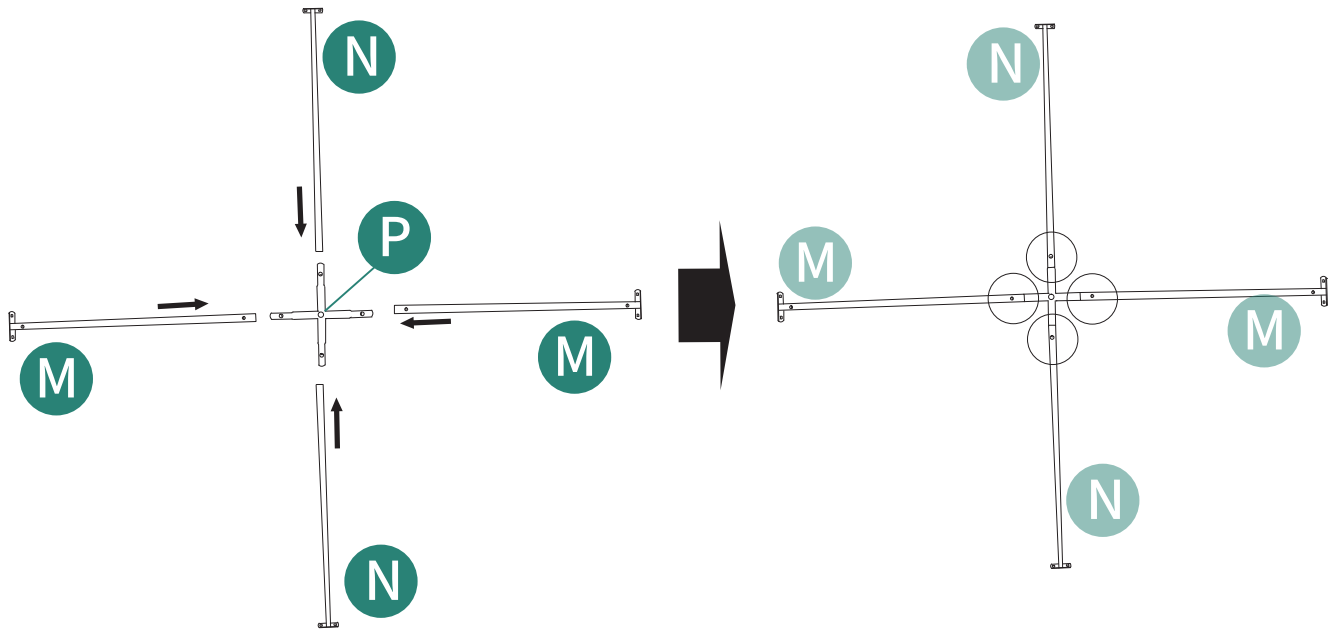

6

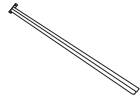

Ⓛ 2pcs

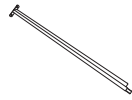

Ⓚ 2pcs



ⓧ 4pcs



① 4pcs

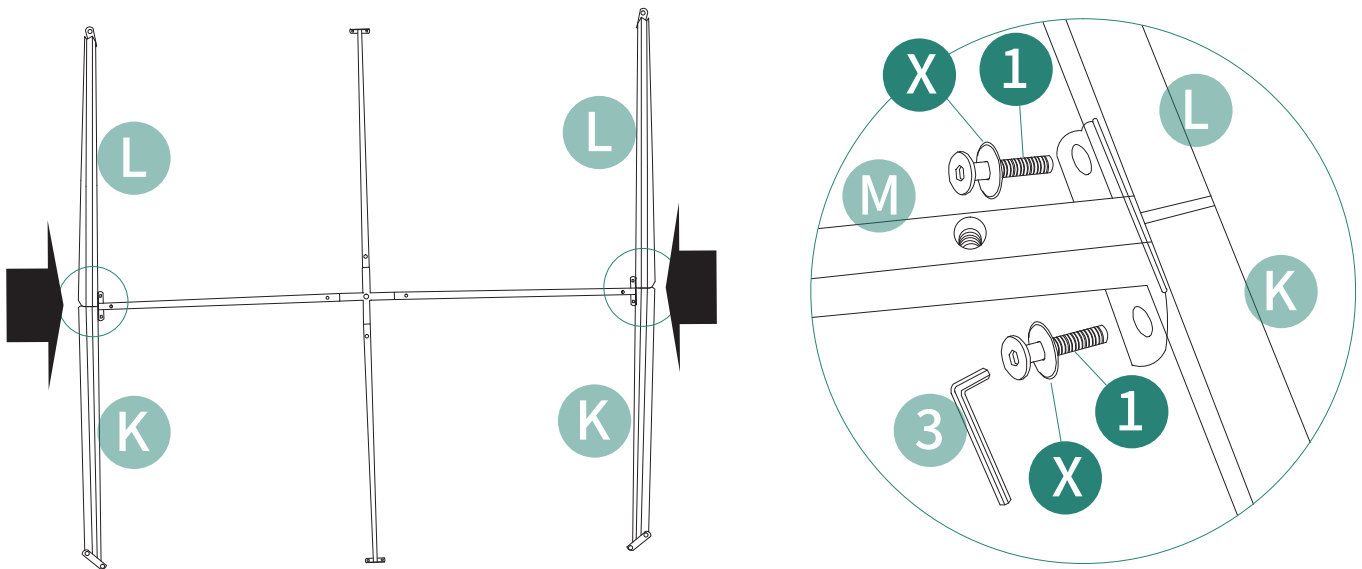
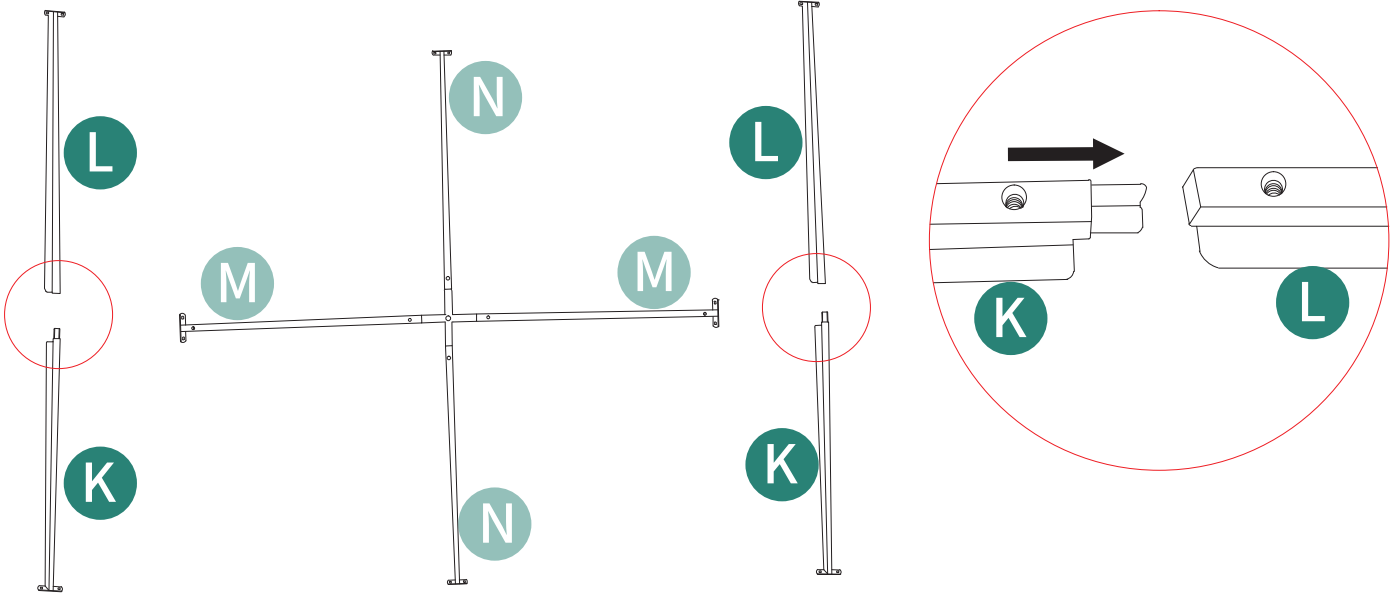

7



Q5pcs

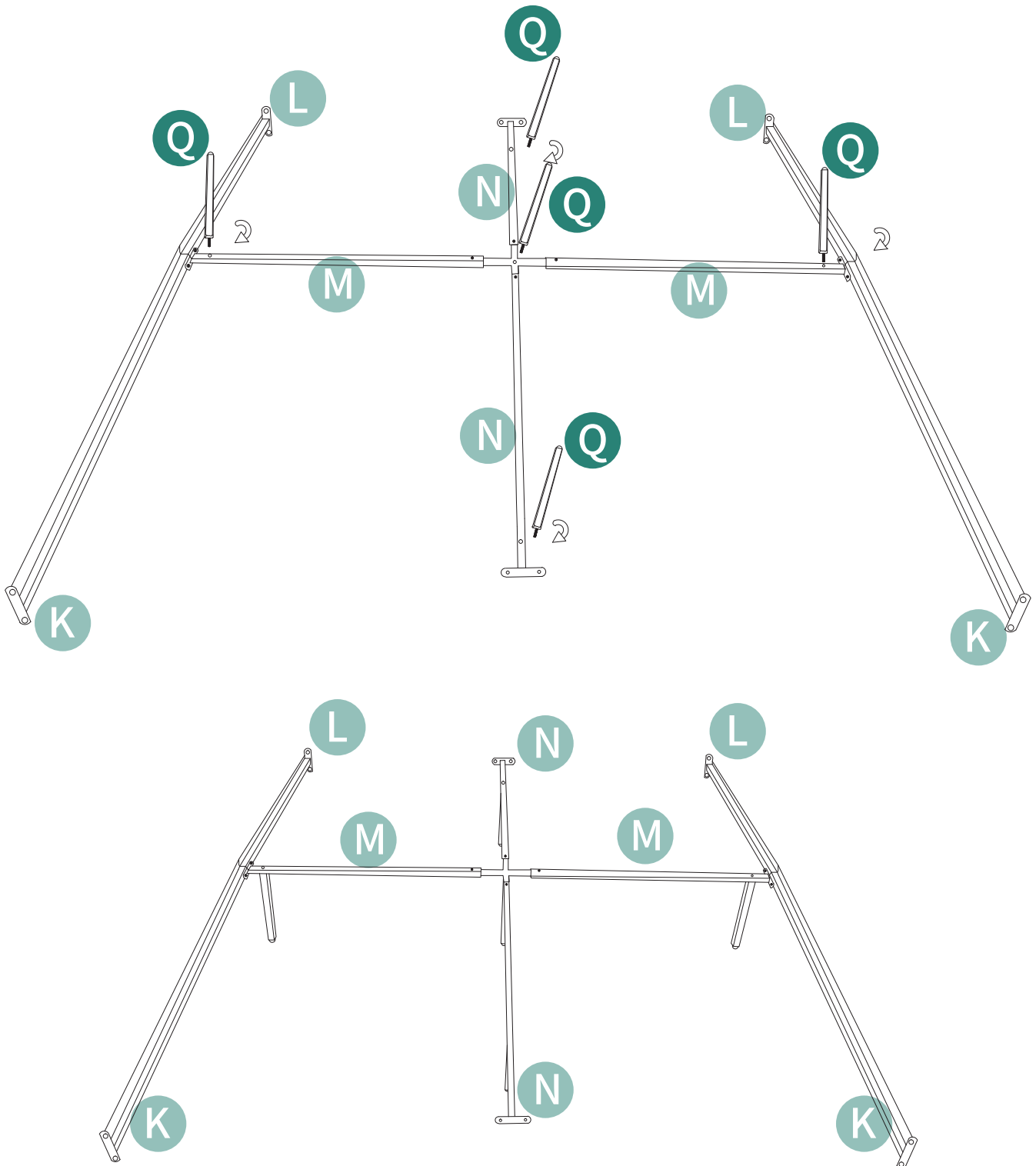

8





ⓧ6pcs

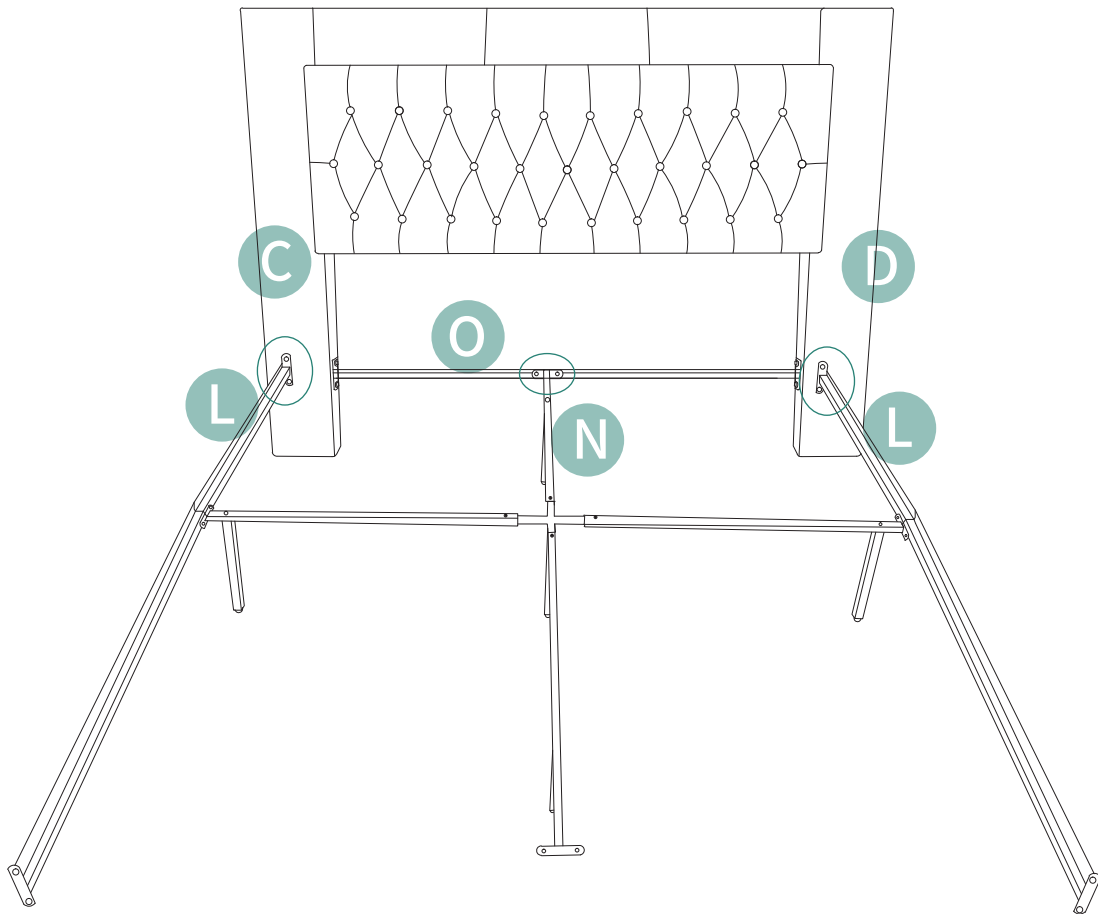
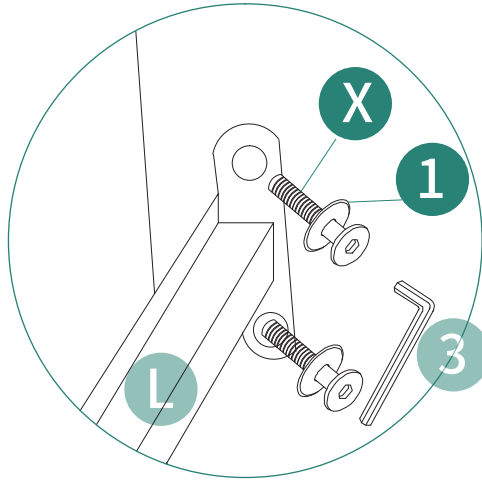

①6pcs



9

 
ⓧ6pcs Ⓛ6pcs

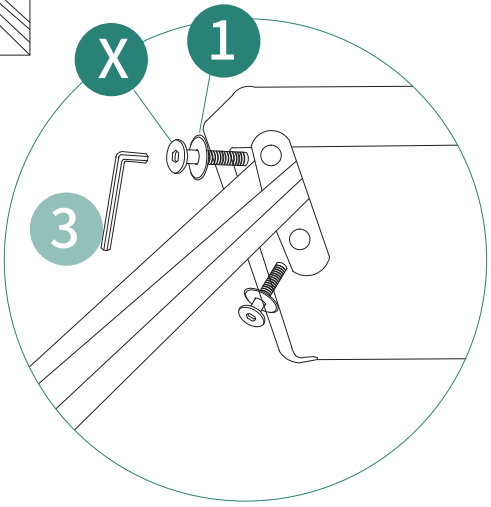
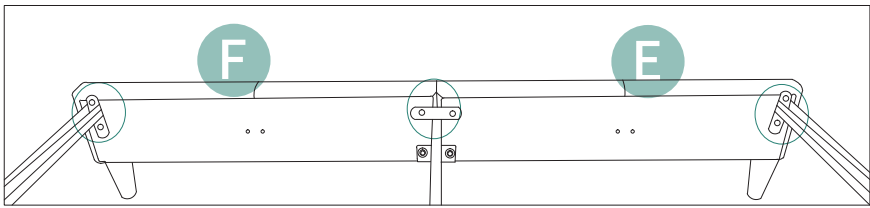
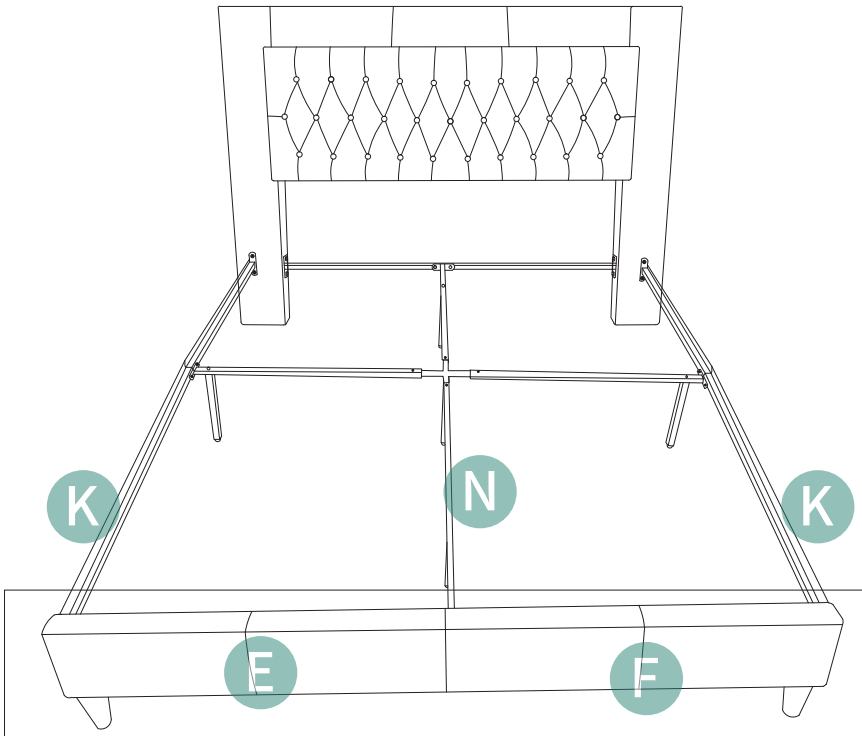

10



Ⓢ2pcs

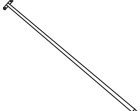

Ⓣ2pcs



ⓧ4pcs



①4pcs

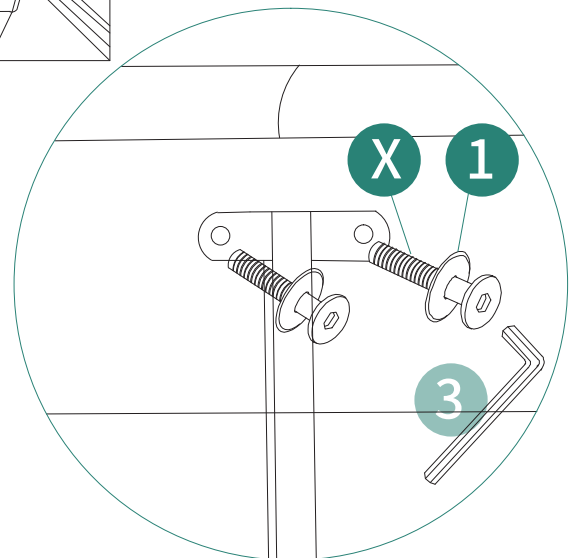
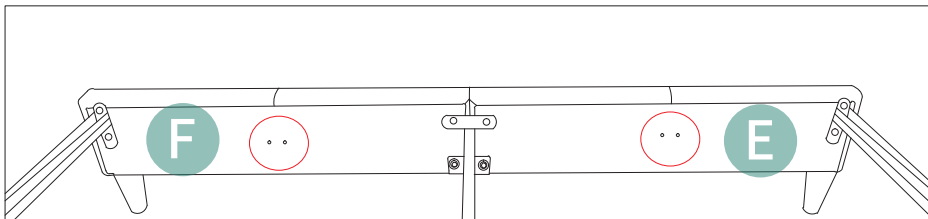
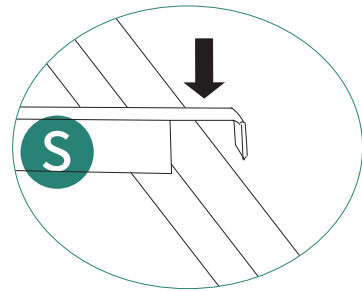
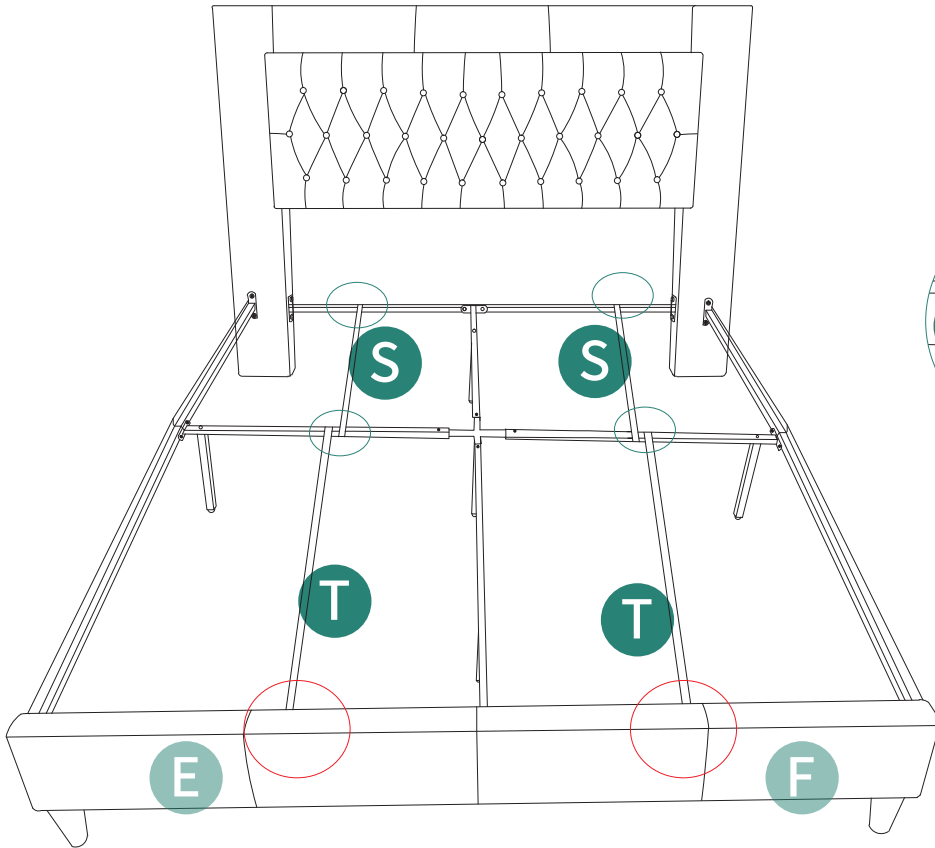

11

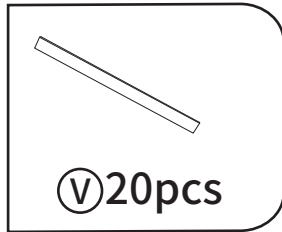

V

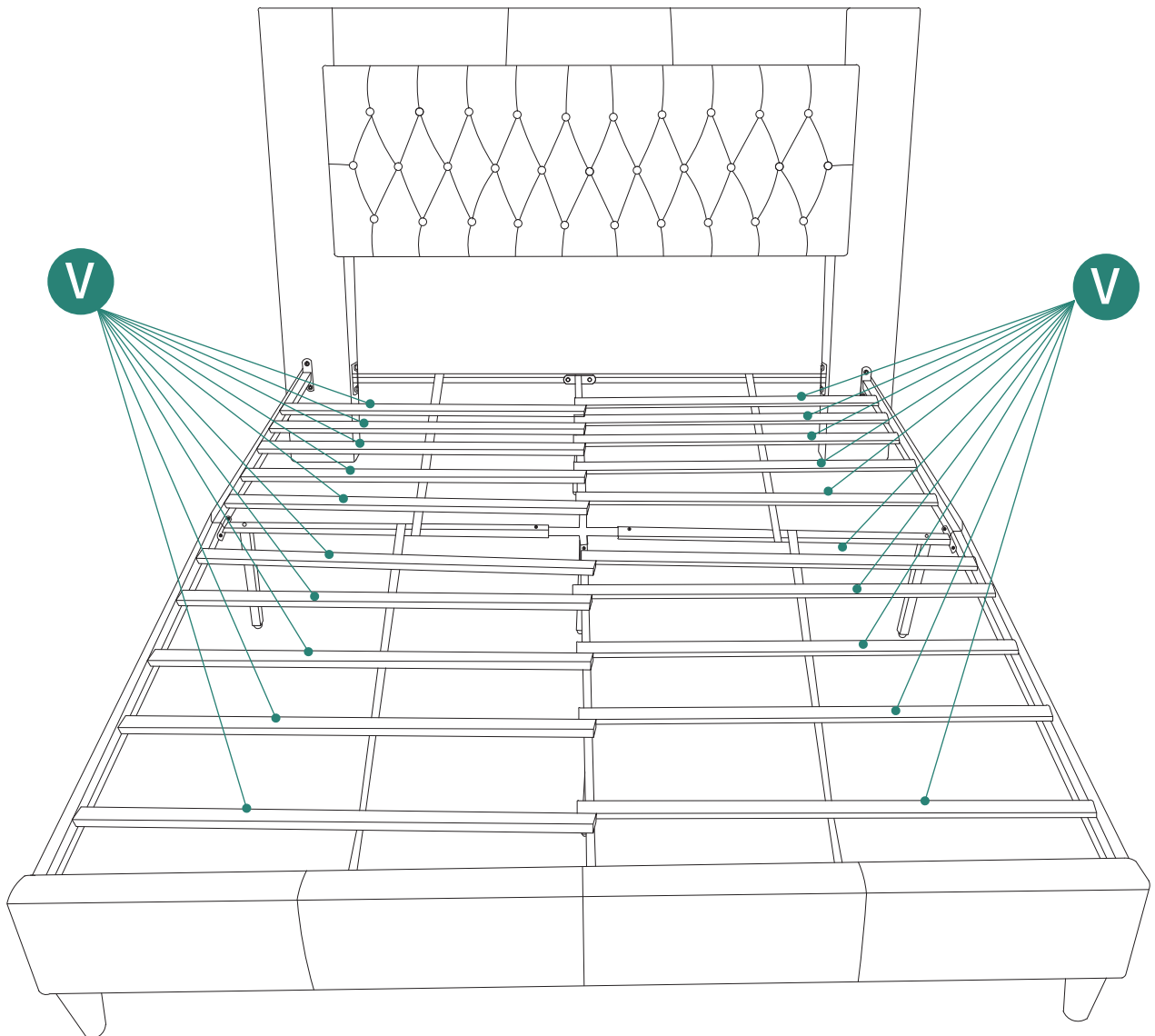
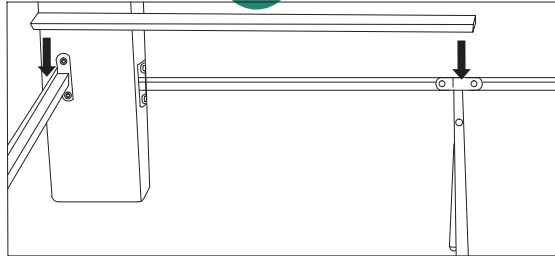

12
X4



ⓐ4pcs



ⓓ4pcs



I*16



Ia*8



Ib*4

ⓔ1pc



Ⓩ20pcs



Ⓩ41pc

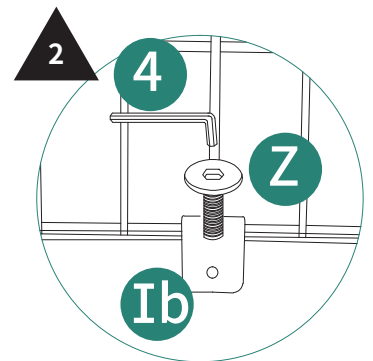
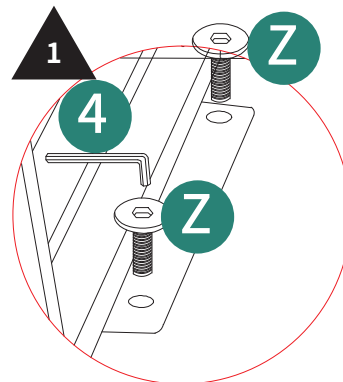
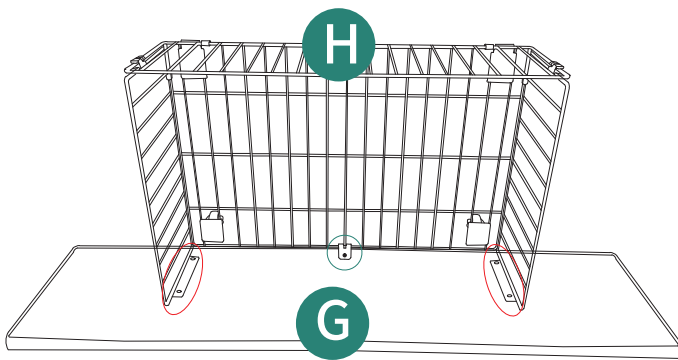
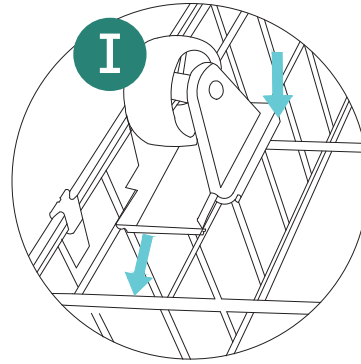
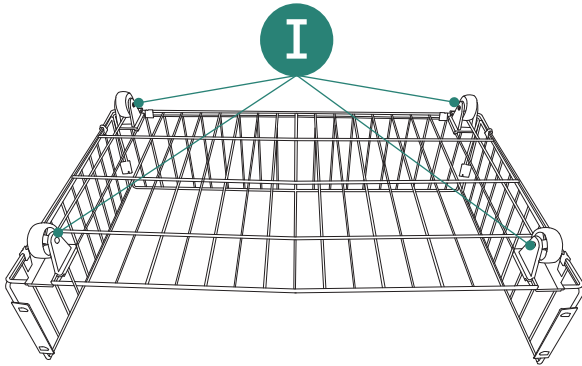
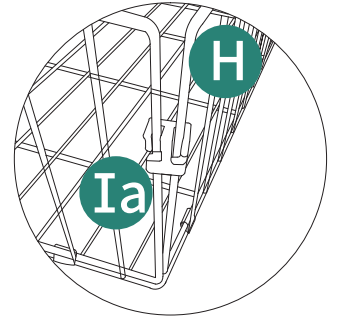
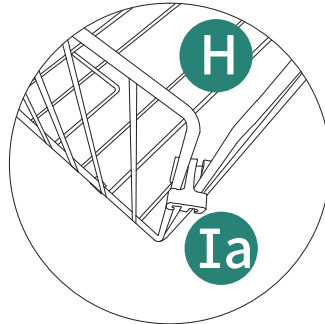

13



14

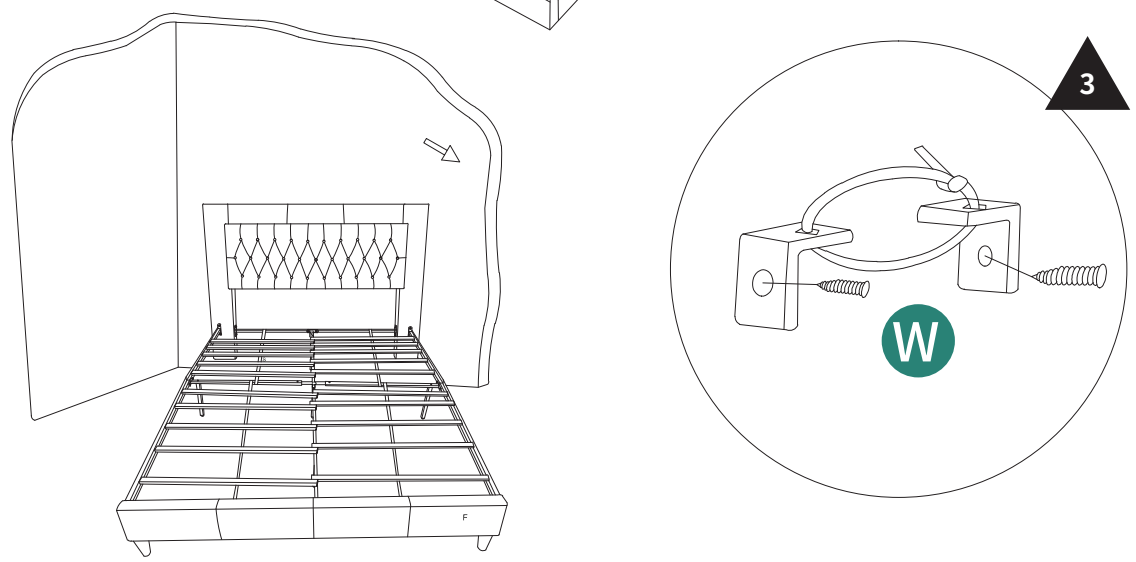
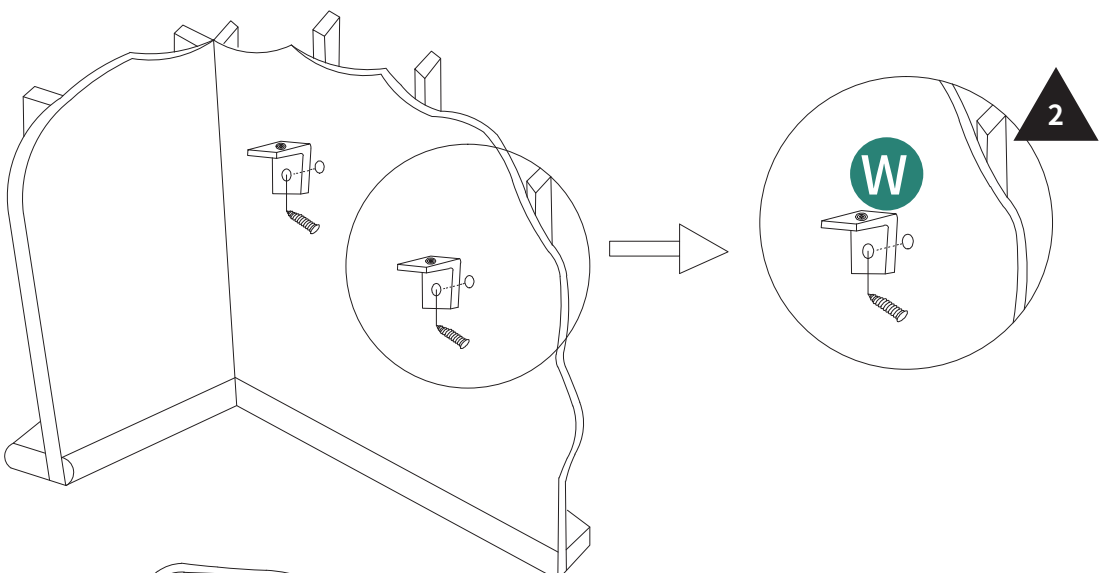
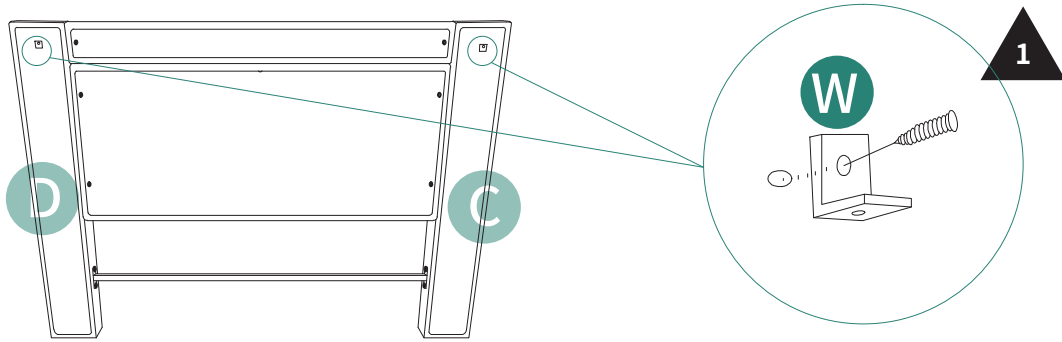
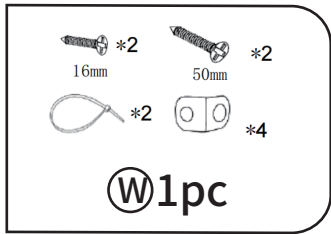

15

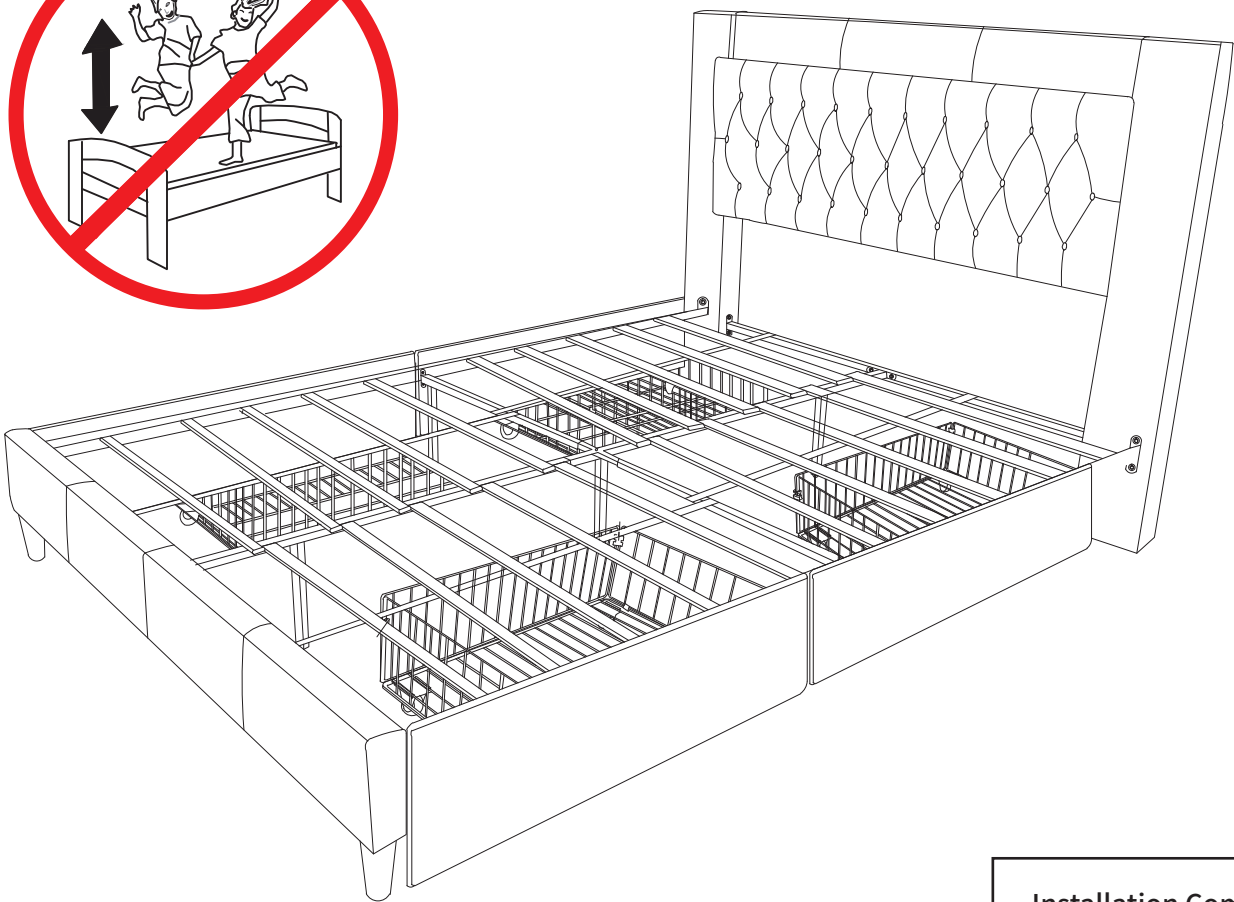

Installation Completed

Installation abgeschlossen

Installation complétée

Installazione completata

Instalación completada