

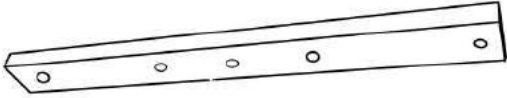









# ASSEMBLING INSTRUCTION

	<p>G  x 1Pcs</p> <p>H  x 3Pcs</p> <p>I  x 3Pcs</p>	
A		x 1Pcs
B		x 2Pcs
C1		x 3Pcs
C2		x 3Pcs
D1		x 2Pcs
D2		x 2Pcs
E		x 2Pcs
F		x 2Pcs

# ASSEMBLING INSTRUCTION

1

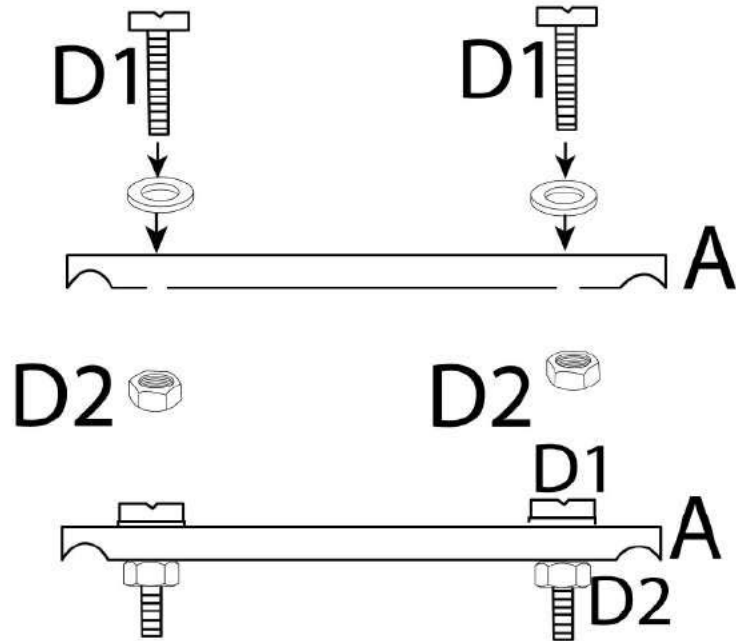

2

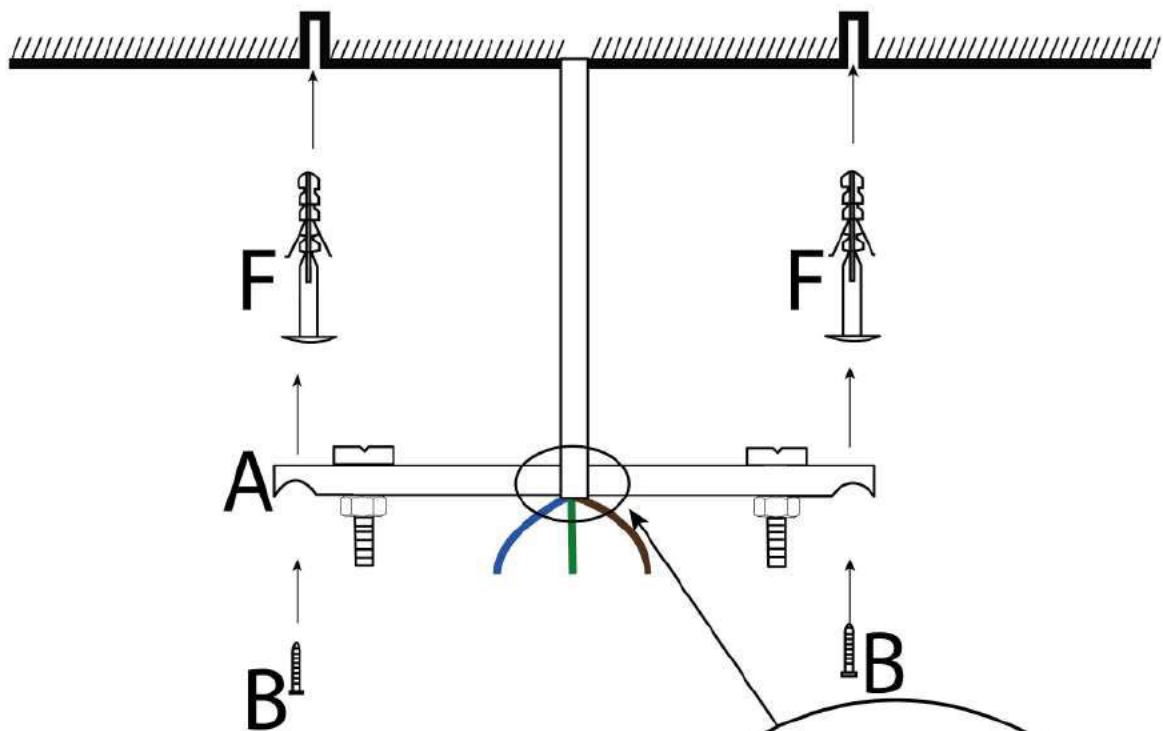

The cable should come next to the bracket

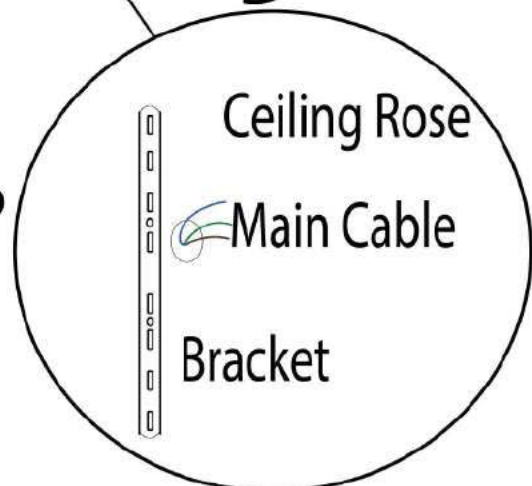

# ASSEMBLING INSTRUCTION

3

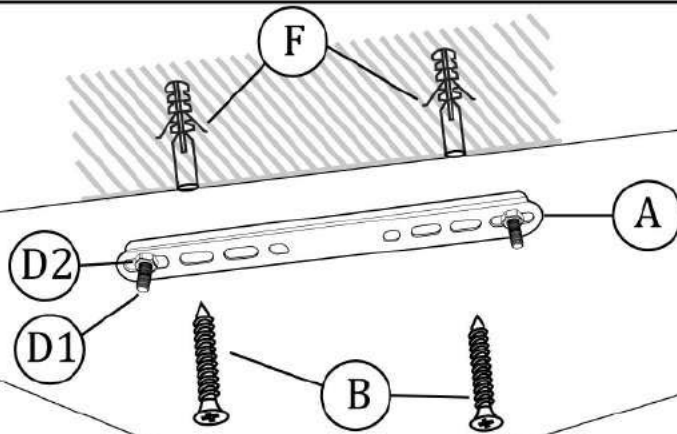

4

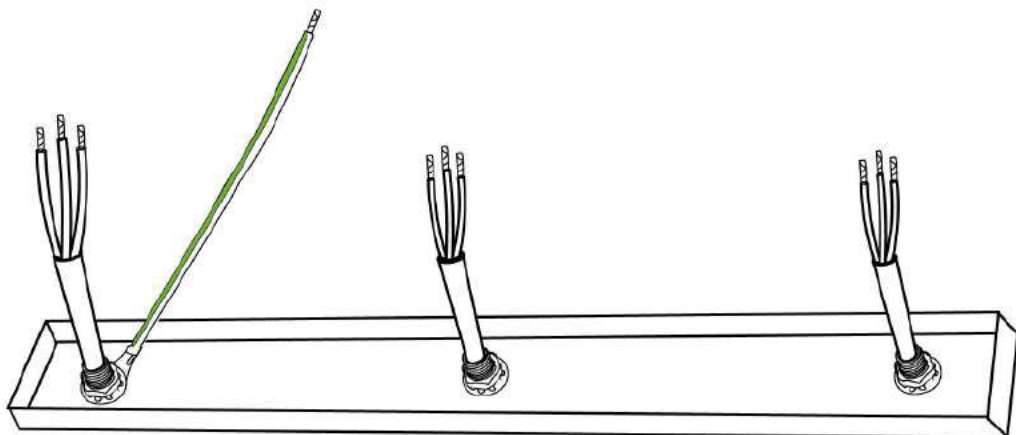
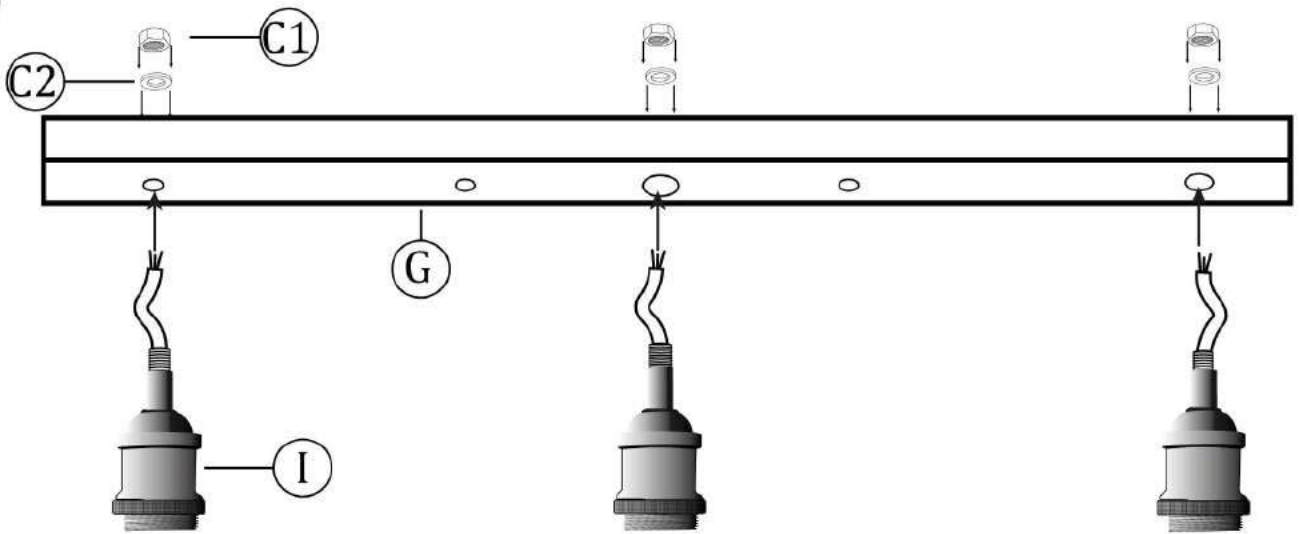

# ASSEMBLING INSTRUCTION

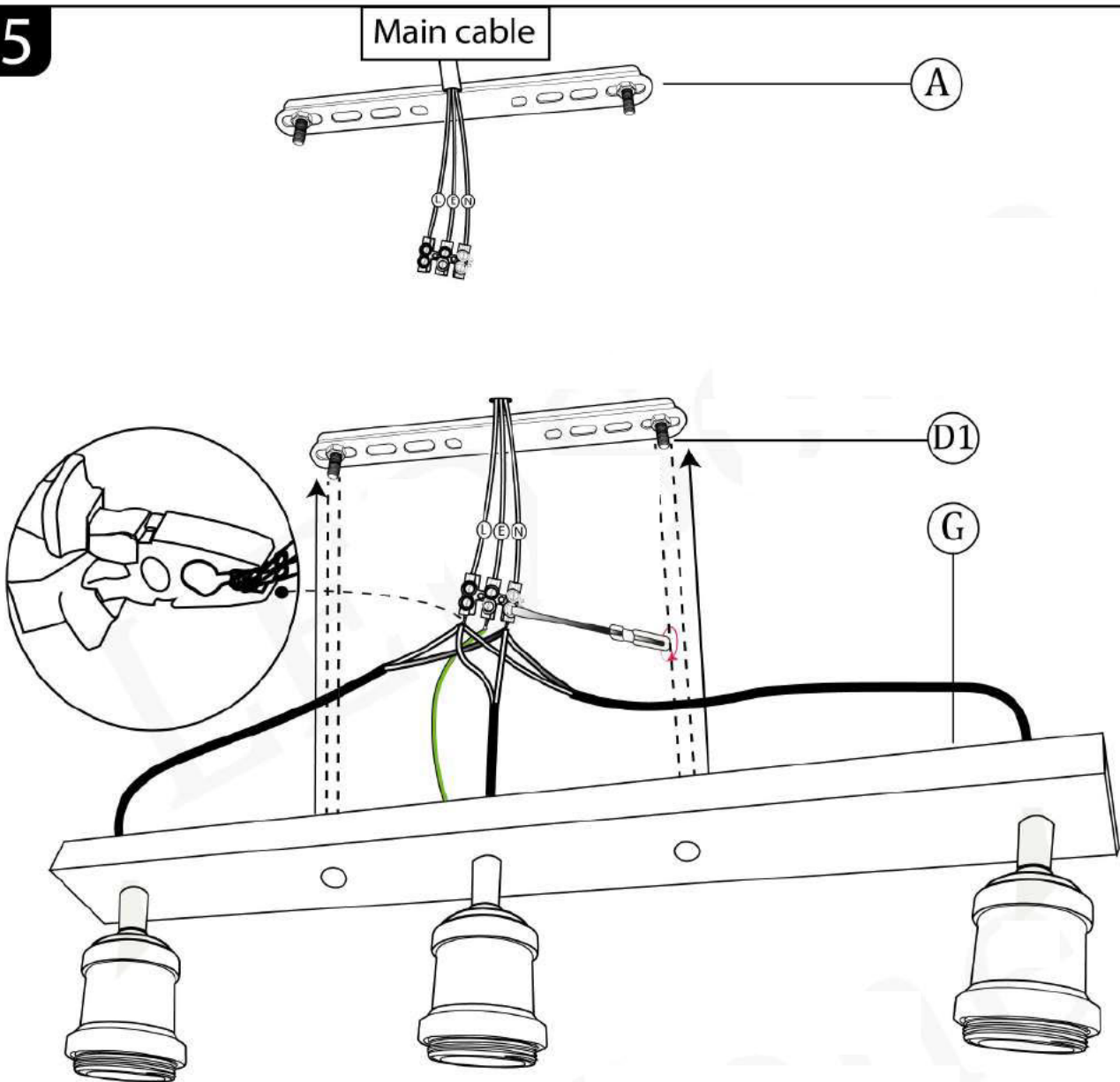
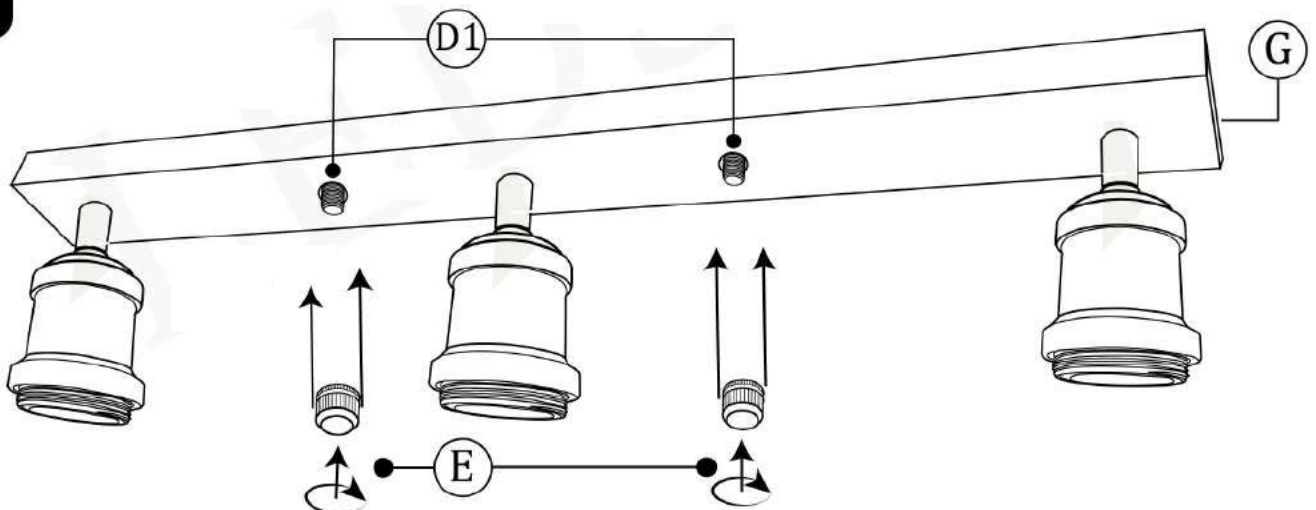
**5****6**

# ASSEMBLING INSTRUCTION

