



WARNING

ASSEMBLY INSTRUCTIONS

"IMPORTANT, RETAIN FOR FUTURE REFERENCE: READ CAREFULLY"

German: WICHTIG, FÜR SPÄTERE NACHSCHLAGE AUFBEWAHREN: SORGFÄLTIG LESEN

Spanish: IMPORTANTE, GUARDAR PARA REFERENCIA FUTURA: LEER ATENTAMENTE

Italian: IMPORTANTE, CONSERVARE PER RIFERIMENTI FUTURI: LEGGERE ATTENTAMENTE

French: IMPORTANT, À CONSERVER POUR RÉFÉRENCE FUTURE : LIRE ATTENTIVEMENT

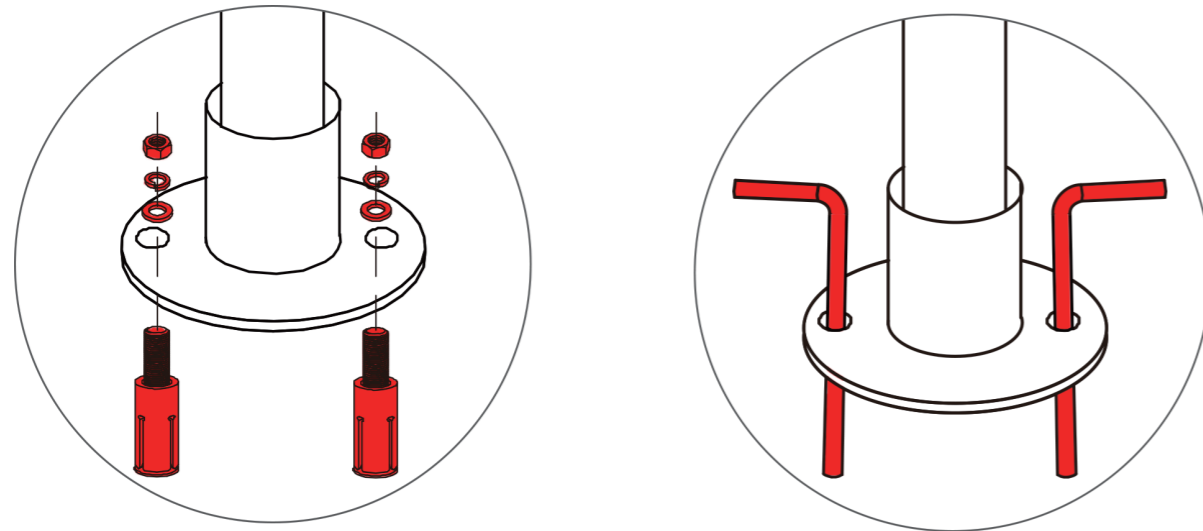

1. Must use ground nails, ropes, and expansions screws for whichever ground you install on for stability to avoid devastating injuries for people inside or nearby and property damage caused by a collapsing gazebo.

2. Do not use this gazebo in high winds, heavy snow, or inclement weather. It is not designed to withstand strong gusts of wind, heavy snow accumulation, or other inclement weather. Must take precautions when the wind speed exceeds 25Mph, and clear snow when it accumulates more than 2 inches.

3. Before use, thoroughly inspect the gazebo to make sure all bolts, nuts, and buckles have been completely tightened and securely fastened.

4. Warranty does not cover damages, losses, or injuries resulting from improper installation, misuse, not using stability accessories mentioned above, non snow cleaning, failure to take precautionary measures, etc.



1. Three or more people are required for the assembly.
2. A ladder is recommended during assembly.
3. Ensure you have all the required parts and organize them before assembling.
4. An electric drill is recommended for the assembly.
5. Do not use candles, matches or open flames of any kind inside or near a tent.
6. Professional installation is highly recommended.

Item no. Nr. N° d'article Articolo No. Artículo No.	Reference Image Referenzbild Image de référence Immagine di riferimento Imagen de referencia	Qty. Menge Qté. Qtà Cant.
1		X28
2		X2
3		X2
4		X10
5		X2
6		X2
7		X14
8		X7
9		X14
10		X12
A		X4
B		X2
C		X10
D		X5
E		X14
F	 M6X55mm	X14
G	 M6X16mm	X28
H		X4

Item no. Nr. N° d'article Articolo No. Artículo No.	Reference Image Referenzbild Image de référence Immagine di riferimento Imagen de referencia	Qty. Menge Qté. Qtà Cant.
a		X14
b	 M6X16mm	X16
e		X4
f	 Tent peg	X28
g		X138
h		X1
j		X2
k		X2
o		X4
p		X30

ASSEMBLY INSTRUCTIONS

ASSEMBLY INSTRUCTIONS

1

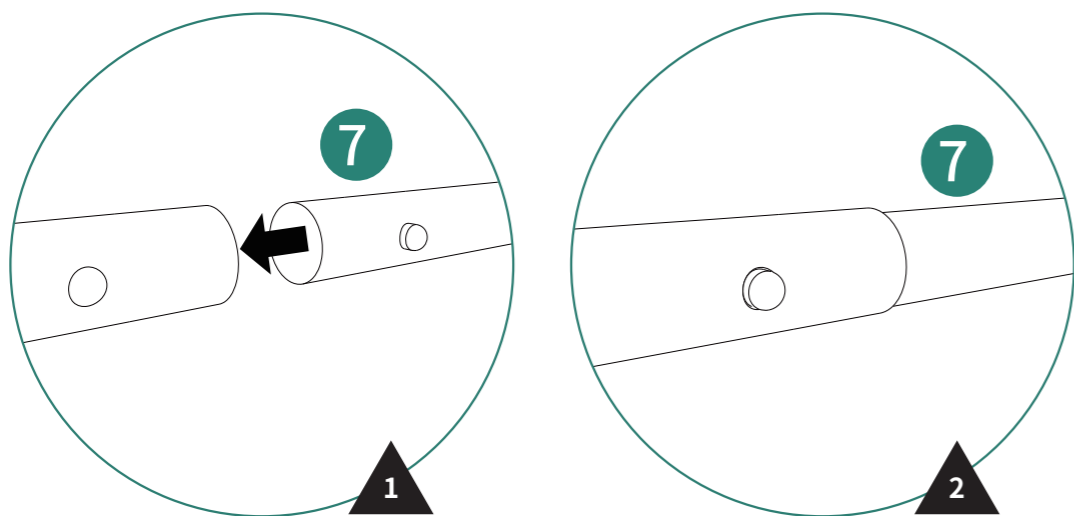
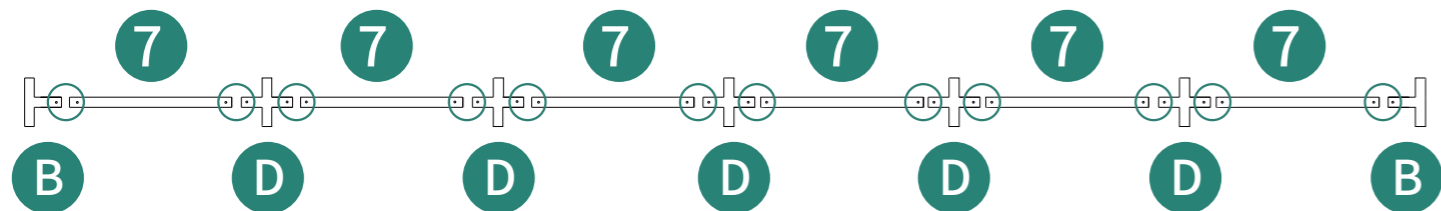
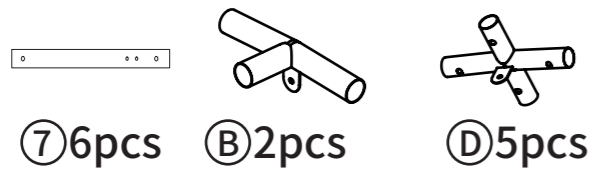

3

2

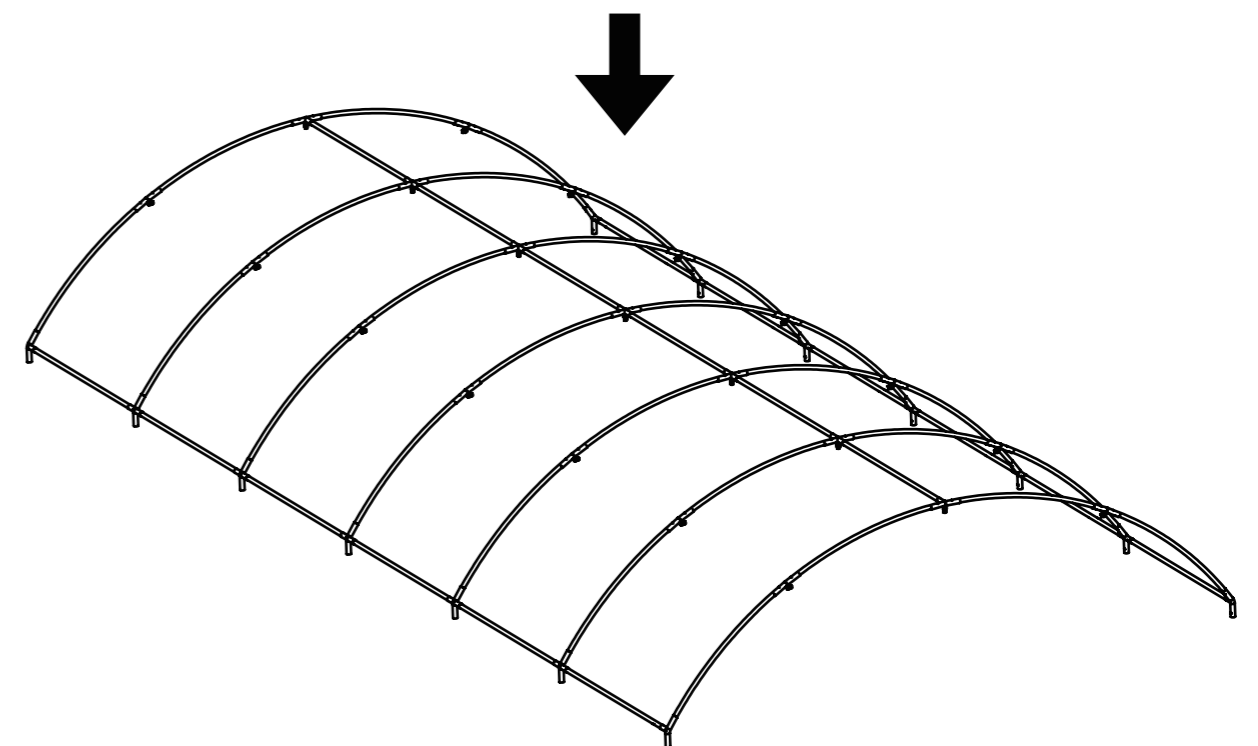
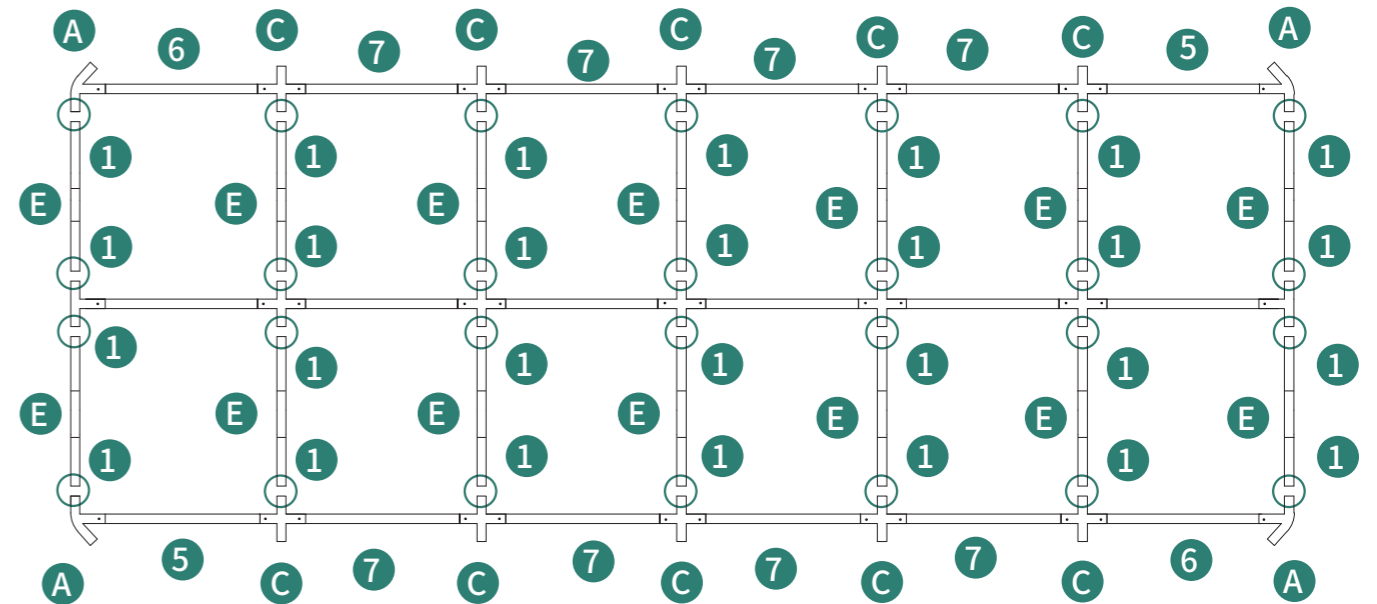
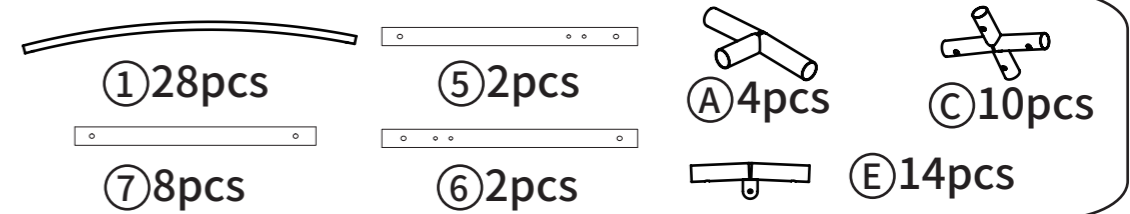

4

ASSEMBLY INSTRUCTIONS

ASSEMBLY INSTRUCTIONS

3

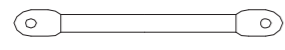

⑧7pcs

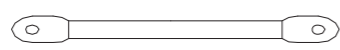

⑨14pcs



ⓐ28pcs

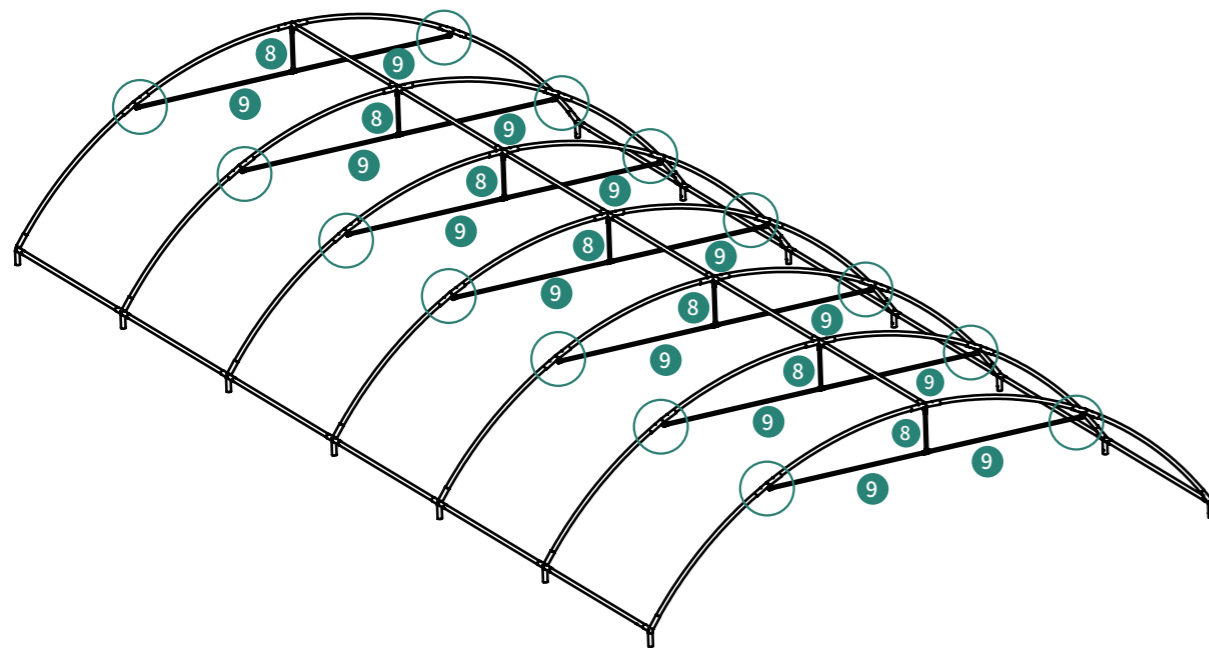

5

4

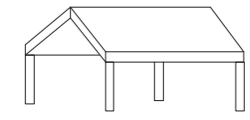

ⓗ1pcs



ⓖ80pcs

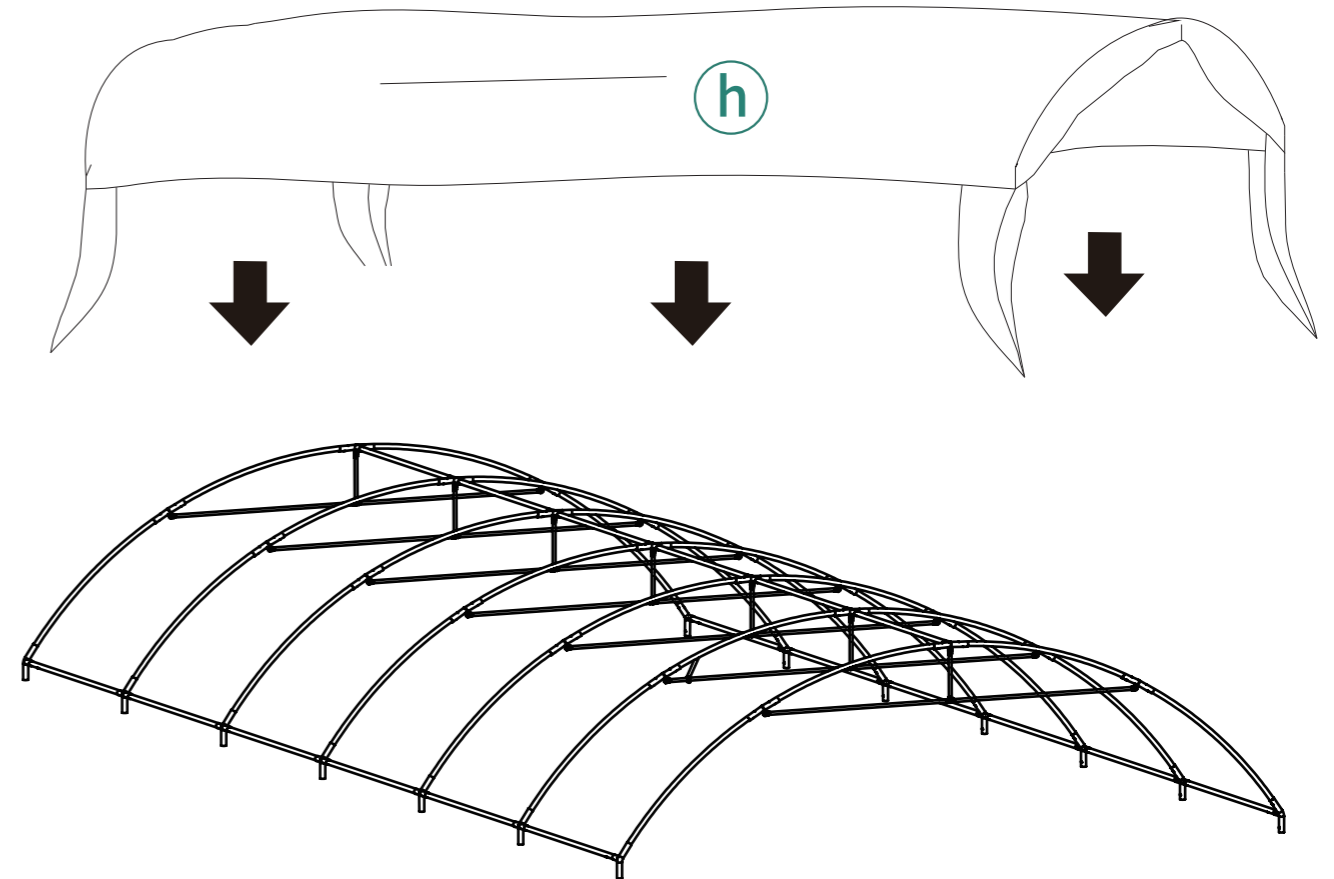

6

ASSEMBLY INSTRUCTIONS

5

- ② 2pcs
- ③ 2pcs
- ④ 10pcs
- Ⓜ 4pcs
- ⓑ 16pcs

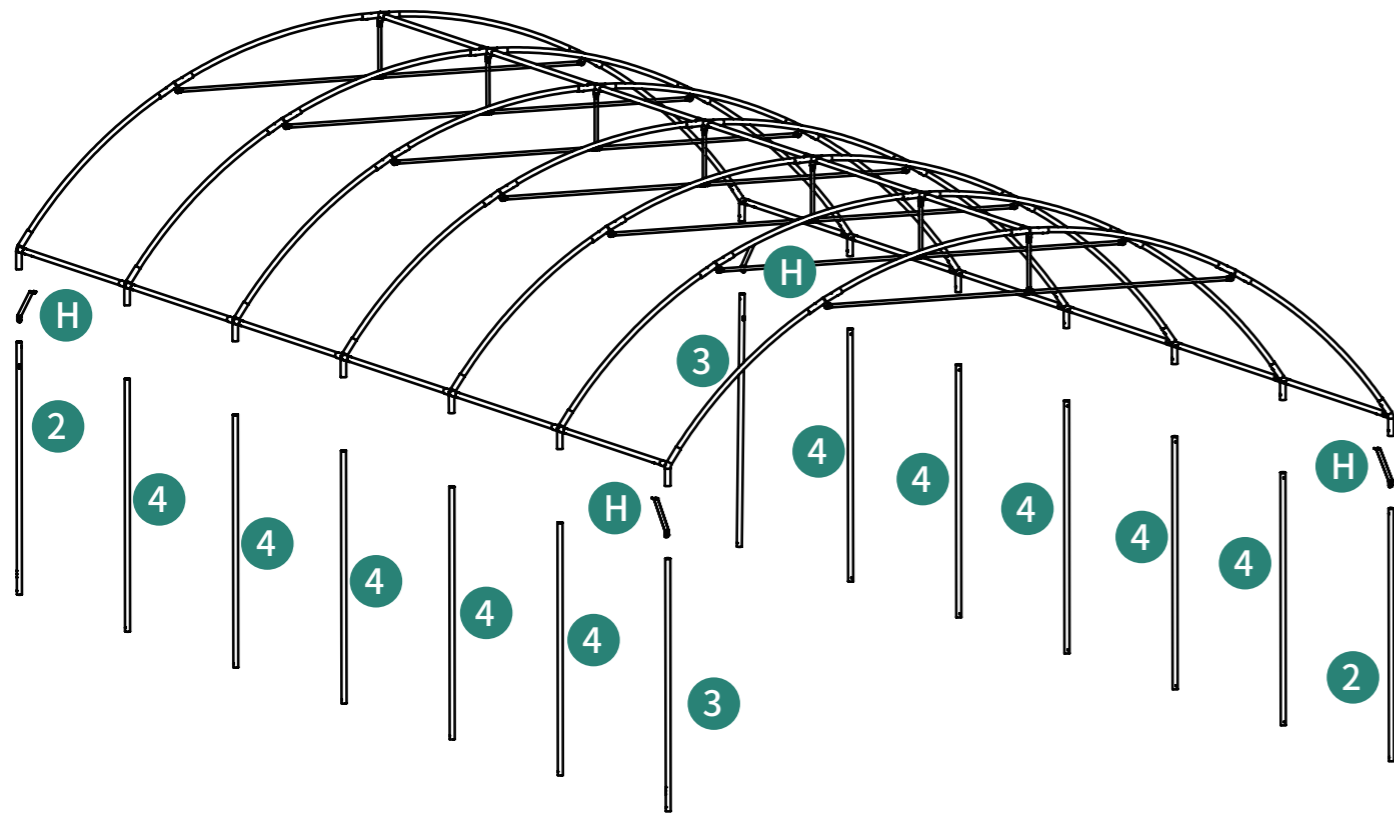

ASSEMBLY INSTRUCTIONS

6

- ⑩ 12pcs
- ⓐ 14pcs
- ⓕ 14pcs

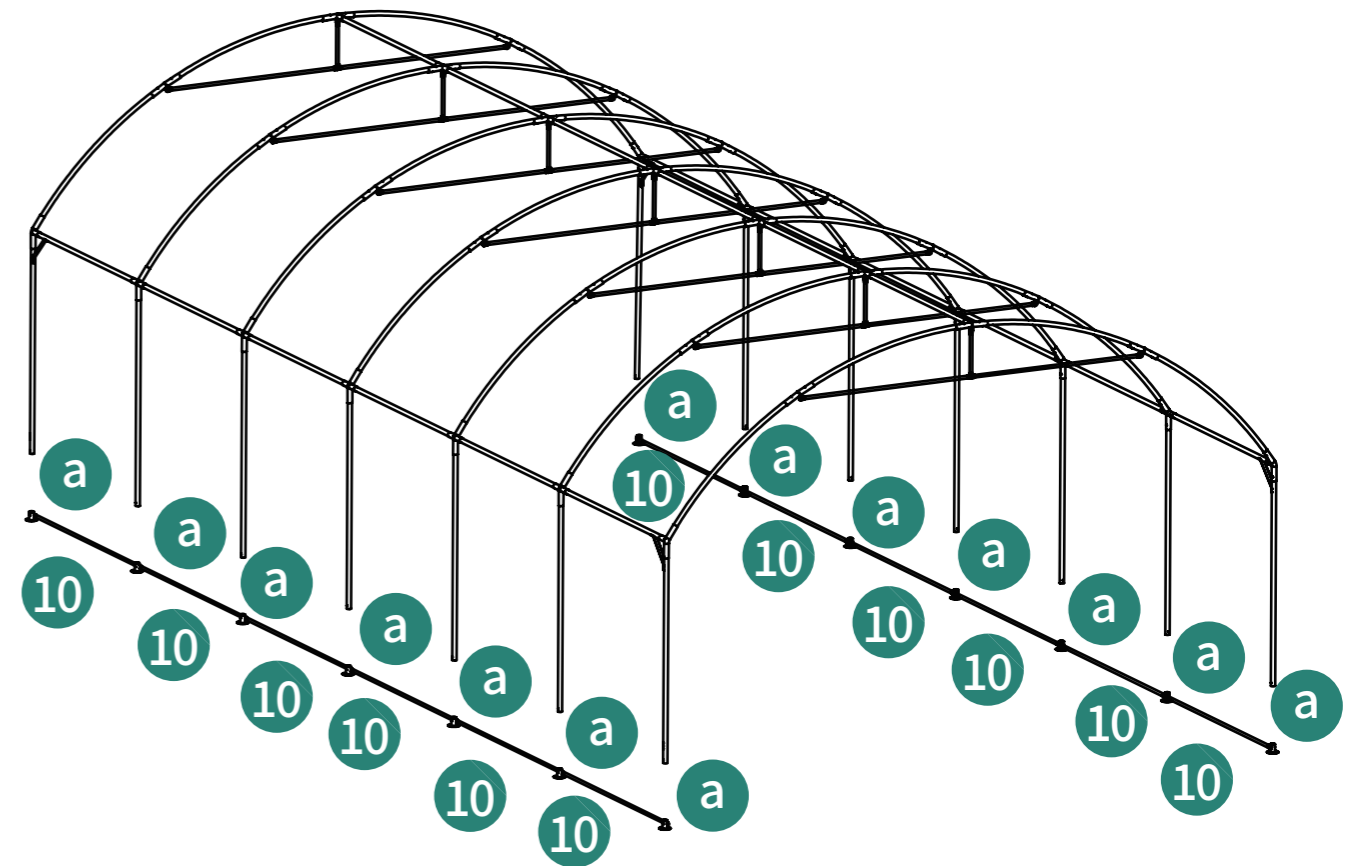

ASSEMBLY INSTRUCTIONS

ASSEMBLY INSTRUCTIONS

7

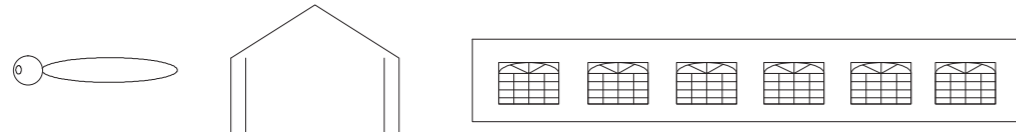

ⓖ 58pcs Ⓚ 2pcs Ⓣ 2pcs

8



φ3 φ6 e

ⓕ 28pcs Ⓞ 8pcs ⓔ 8pcs

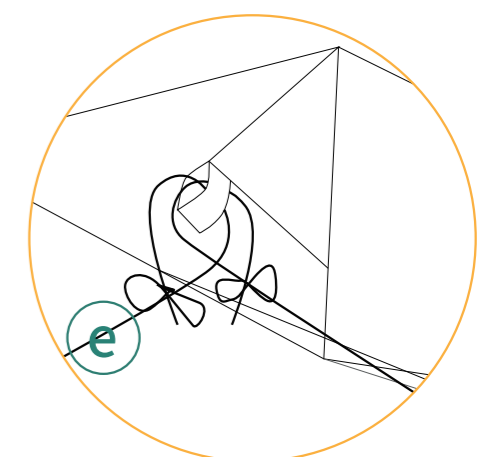
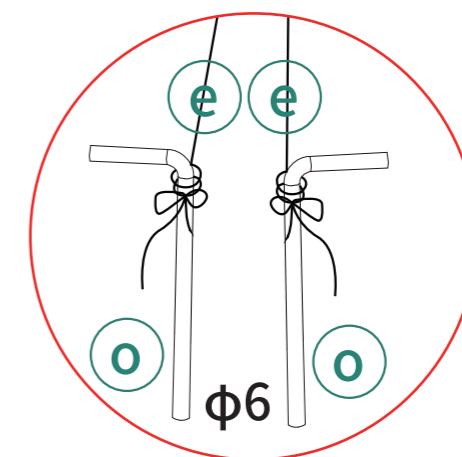
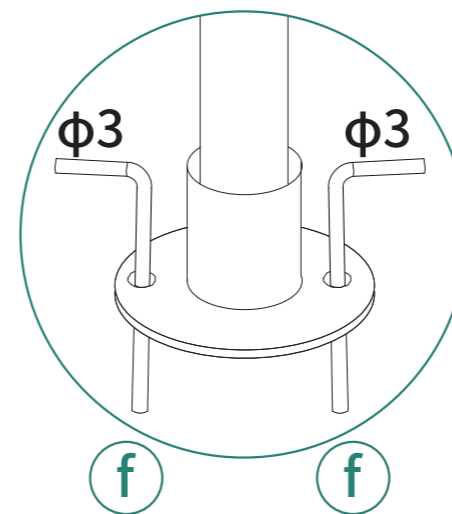
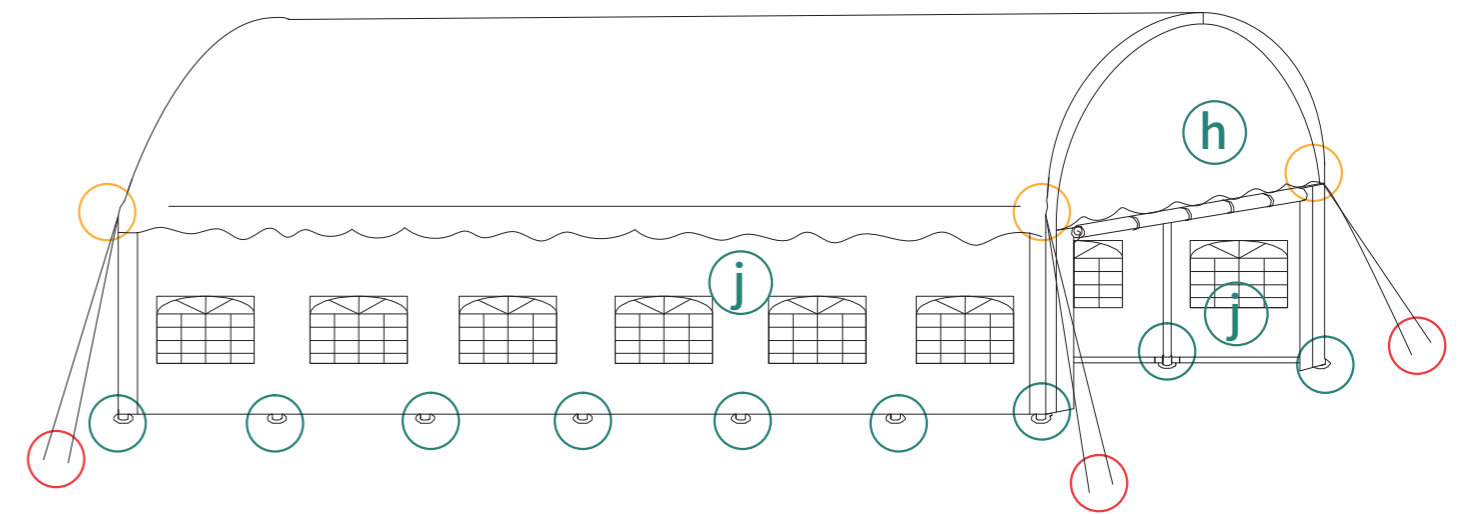
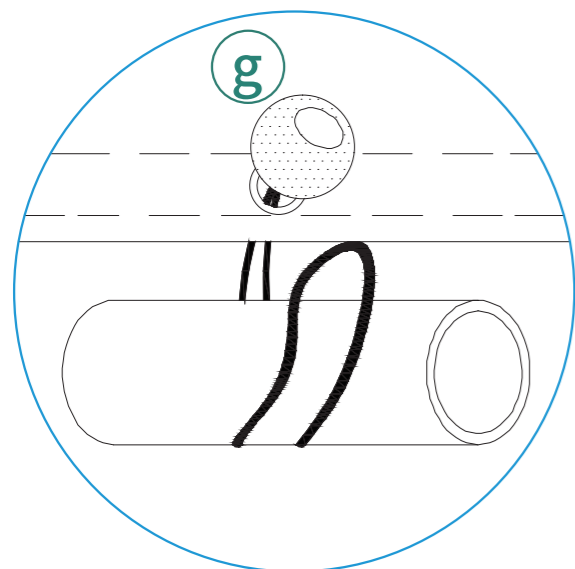
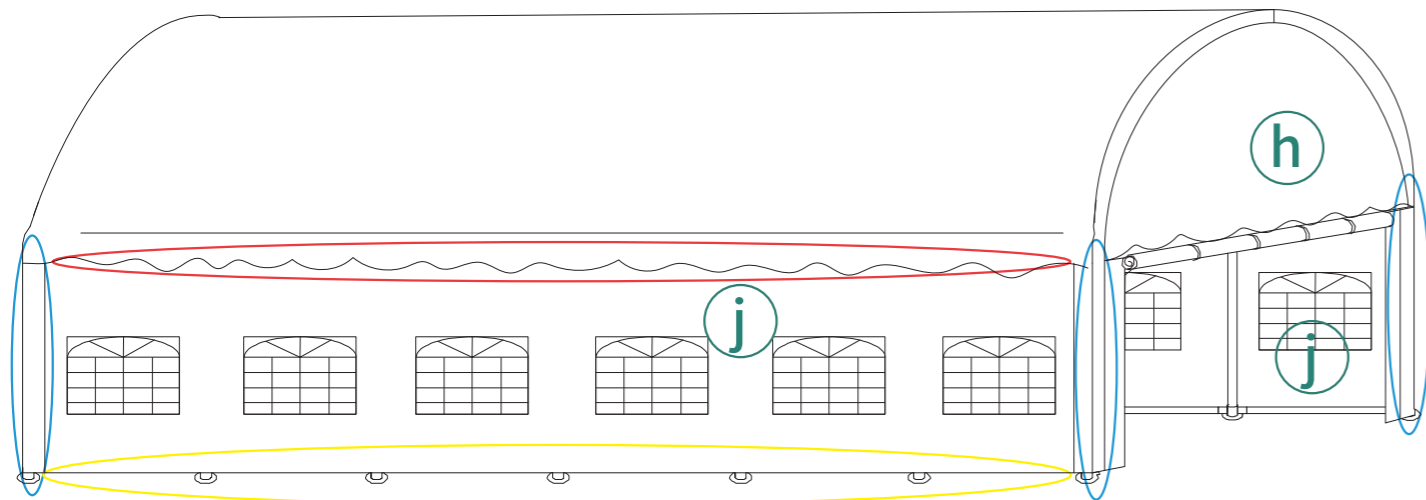

9

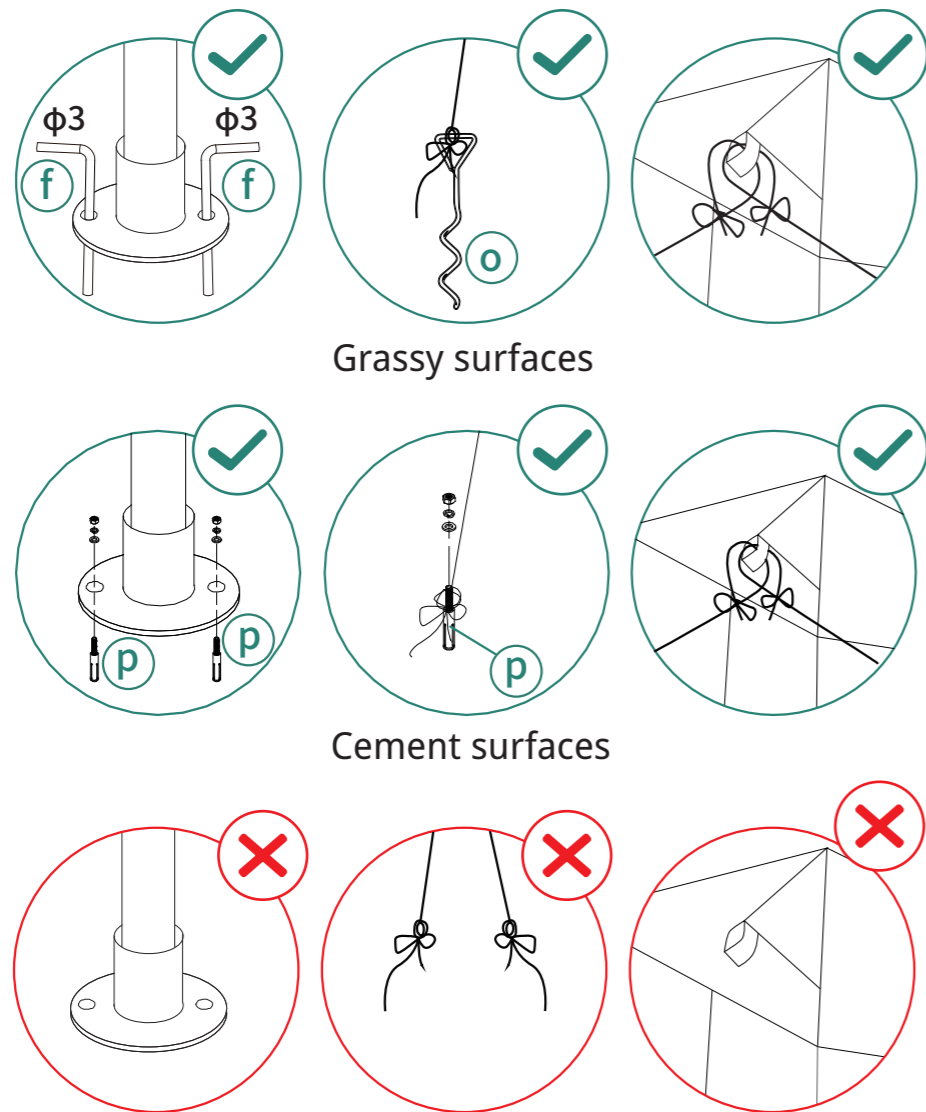

Grassy surfaces

Cement surfaces

To improve wind resistance,
be sure to complete this installation step. If expansion screws or ground nails are not installed, strong winds may topple the gazebo.
 Expansion screws are essential for stability on cement surfaces, and ground nails are for grassy surfaces.
 All are included in the accessories package.

10

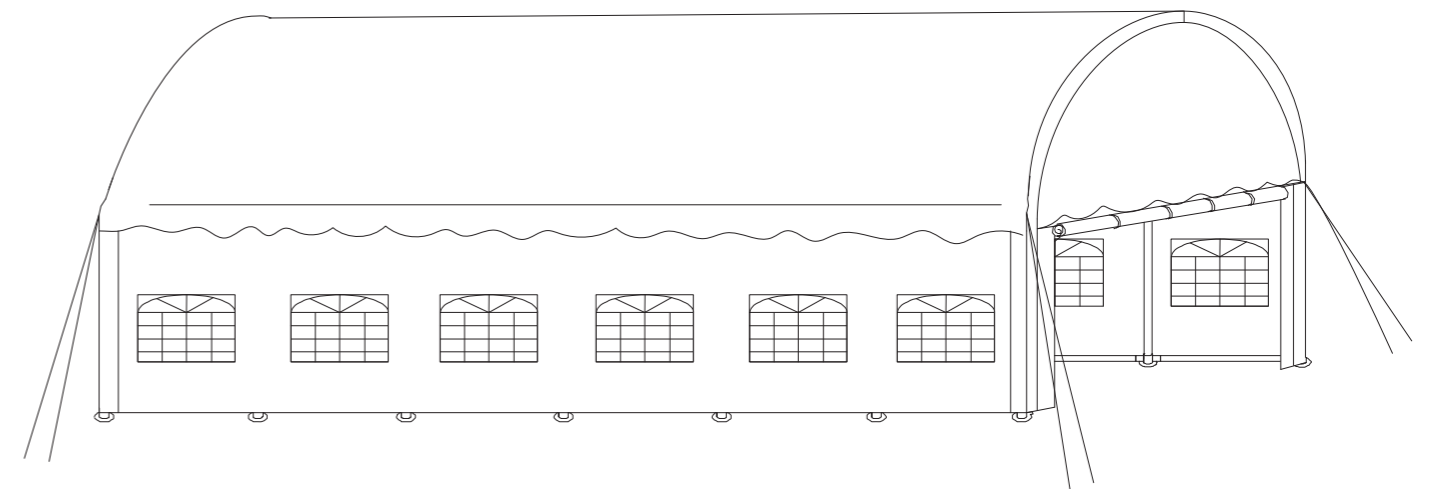

Installation Completed