











Assembly Instructions

Caution : You must read this before you proceed

Care & Maintenance

- ⊘  ● Not for commercial use. For residential use only.
 - ✓  ● Furniture may scratch floors. We recommend using furniture pads to protect your floors.
 - ⊘  ● Do not put hot items directly on furniture surface.
 - ⊘  ● Do not clean furniture with harsh cleansers or polish.
 - ⊘  ● Do not place furniture under direct sunlight.
 - ⊘  ● Do not place furniture near heating or cooling vents.
 - ⊘  ● Do not write on furniture without a padded barrier to protect the surface.
 - ⊘  ● Do not place furniture outside . For indoor use only.
 - ⊘  ● Stains may be removed with mild soap solution and damp cloth.
 - ⊘  ● Children should not climb or jump on the furniture.
- ✓  ● Dust and pick-up spills using a clean, non-colored, lint-free cloth.

BED

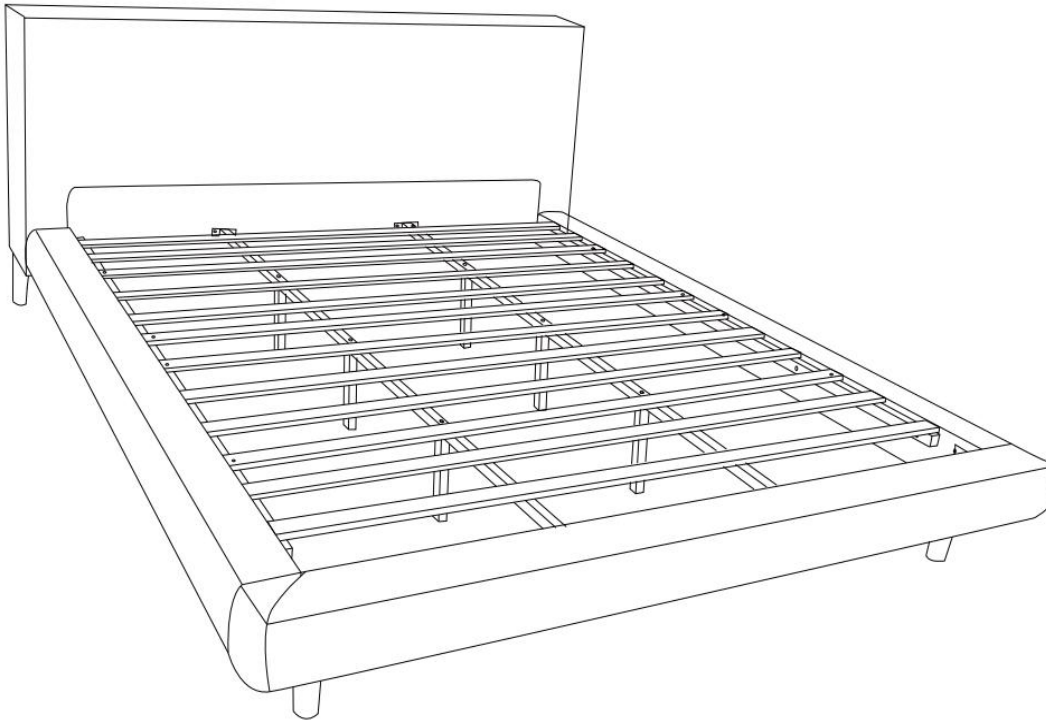









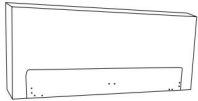

NOTE : This Bed is NOT a TOY.

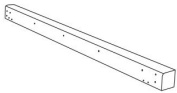
Keep your child / children at bay during the assembly process.





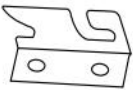

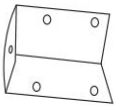
The Daybed is **HEAVY**.

To prevent injury to yourself or damage to the product a minimum of two adults are required whenever moving or lifting the product.

Parts List

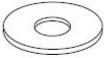
Label	Picture	Description	QTY
A		Headboard	1
B		Bed tailboard	1
C		Bed side panel	2
D		Bed legs	4
E		Bed slat	1
F		The rib support strips on the side panels of the bed	2
G		Headboard and footboard connecting rods	2
H		Connecting rod support foot	6
I		A hanging piece is connected to the right side of the bed and the head of the bed	1
J		A hanging piece is connected to the left side of the bed and the head of the bed	1
K		Reinforcement hardware for the head, tail and sides of the bed	4
L		Hardware hanging pieces at the end of the bed	2











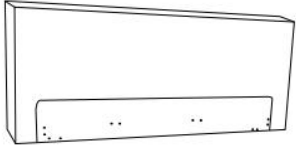
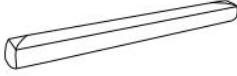
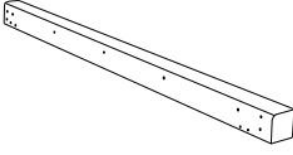

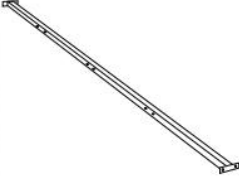

Hardware List

Label	Picture	Description	QTY
①		Bolt(M8 x20mm)	36
②		Bolt(M8 x40mm)	26
③		Flat Washer	10
④		Allen Key N6	1
⑤		Screw	8
⑥		Nut	12
⑦		Open-end wrench	1

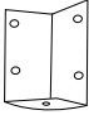
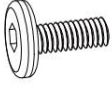
Assembly Preparation

Before
Beginning
Assembly:

N769P362092

<p>A</p>  <p>X1</p>	<p>B</p>  <p>X1</p>	<p>C</p>  <p>X2</p>	<p>D</p>  <p>X4</p>
<p>E</p>  <p>X1</p>	<p>F</p>  <p>X2</p>	<p>G</p>  <p>X2</p>	<p>H</p>  <p>X6</p>
<p>I</p>  <p>X1</p>	<p>J</p>  <p>X1</p>	<p>K</p>  <p>X4</p>	<p>L</p>  <p>X2</p>
<p>1</p>  <p>Bolts(M8x 20mm) X36</p>	<p>2</p>  <p>Bolts(M8x 45mm) X26</p>	<p>3</p>  <p>Flat Washer X10</p>	<p>4</p>  <p>X1</p>
<p>5</p>  <p>X8</p>	<p>6</p>  <p>X12</p>	<p>7</p>  <p>X1</p>	



- Read instructions, cover to cover-



- Have 2 adults on hand for assembly-



- Do not assemble on flooring or carpet-



- Assemble on a clean non-marring surface (packing foam)-



- Save all packaging until finished-

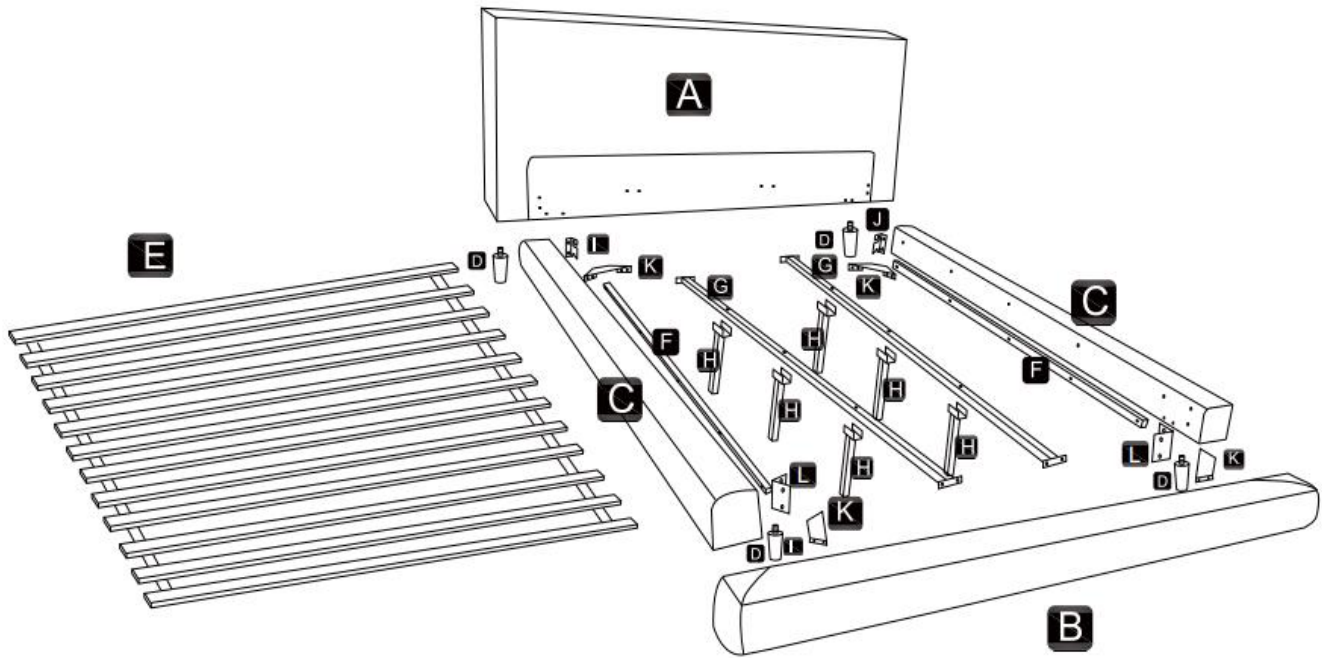

Overview



This Bed has multiple parts and may require up to 60 minutes to assemble.

To give you an overview of the Bed parts, the above picture is to help you put the various Bed parts into perspective. Please read through the instructions below to familiarise yourself with the parts and steps before assembly.

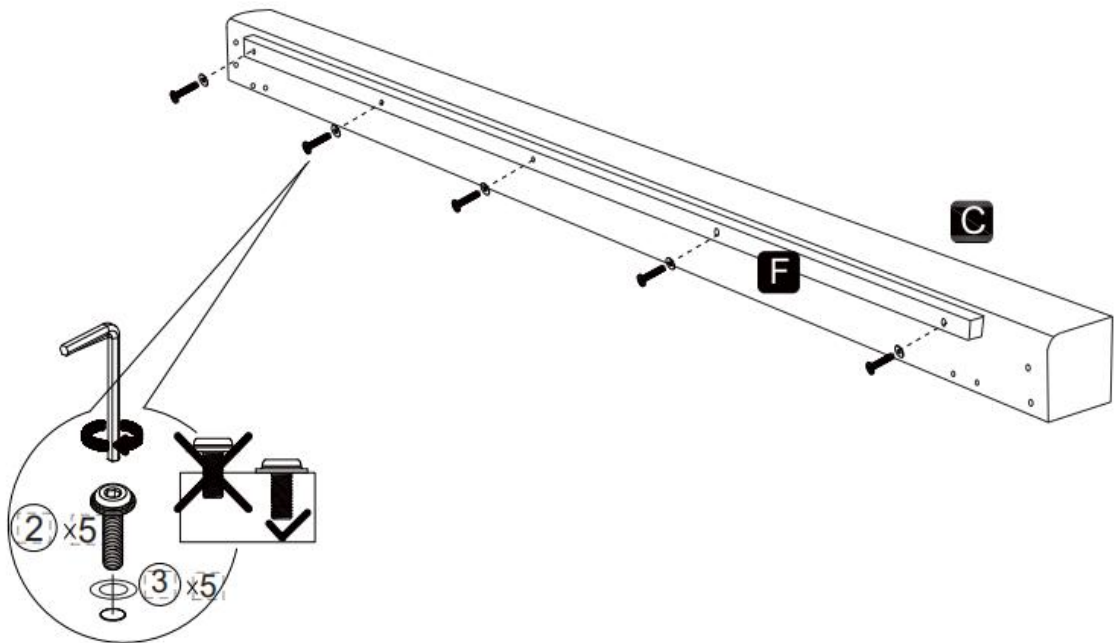

Step 1

2		x5
3		x5
4		x1



Install the rib support strip (F) on the bed side plate to the bed side plate (C) with bolts (2) and washers (3), and tighten it with an Allen wrench (4). Note: tighten the bolt completely.

Step 2

2		x5
3		x5
4		x1

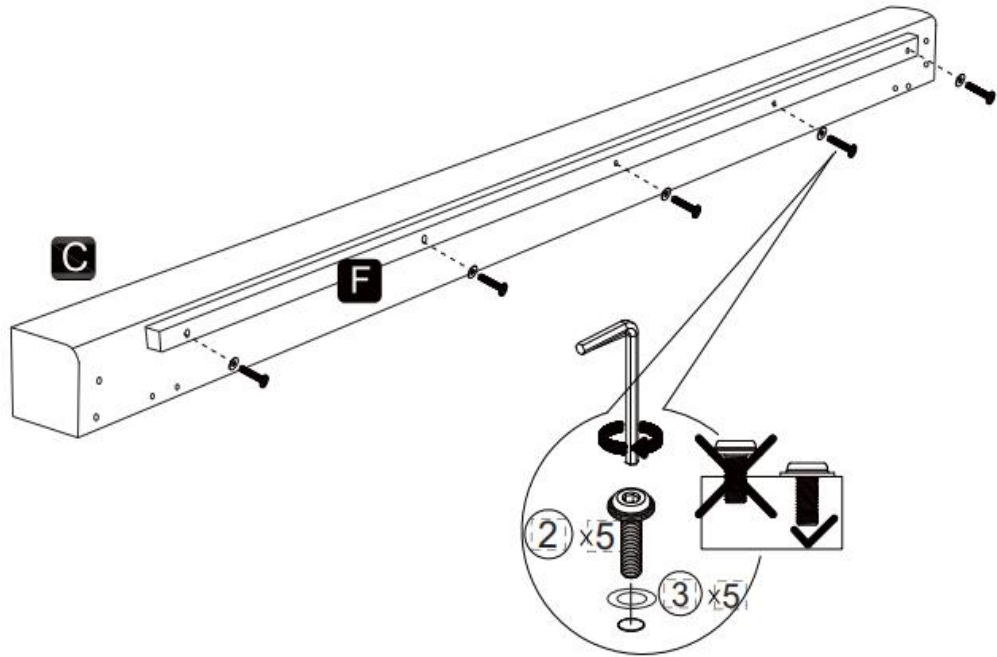

Install the rib support strip (F) on the bed side plate to the bed side plate (C) with bolts (2) and washers (3), and tighten it with an Allen wrench (4). Note: tighten the bolt completely.

Step 3

1		x4
4		x1

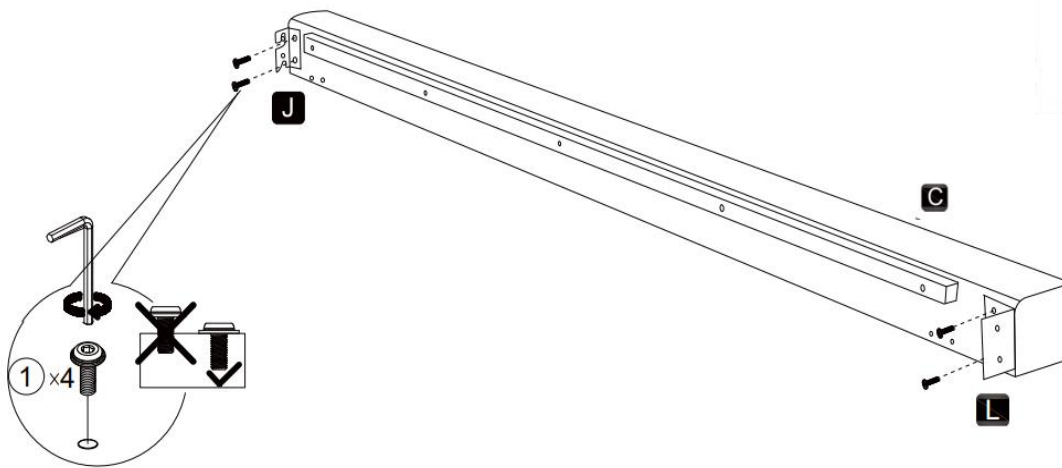

Use bolts (1) to install the left bed side and headboard connection plate (J) and the bed tail foot hanging plate (L) onto both ends of the bed side plate (C), and then tighten them with an Allen wrench (4). Note: Do not tighten the bolt completely.

Step 4

- | | | |
|---|---|----|
| 1 |  | x4 |
| 4 |  | x1 |

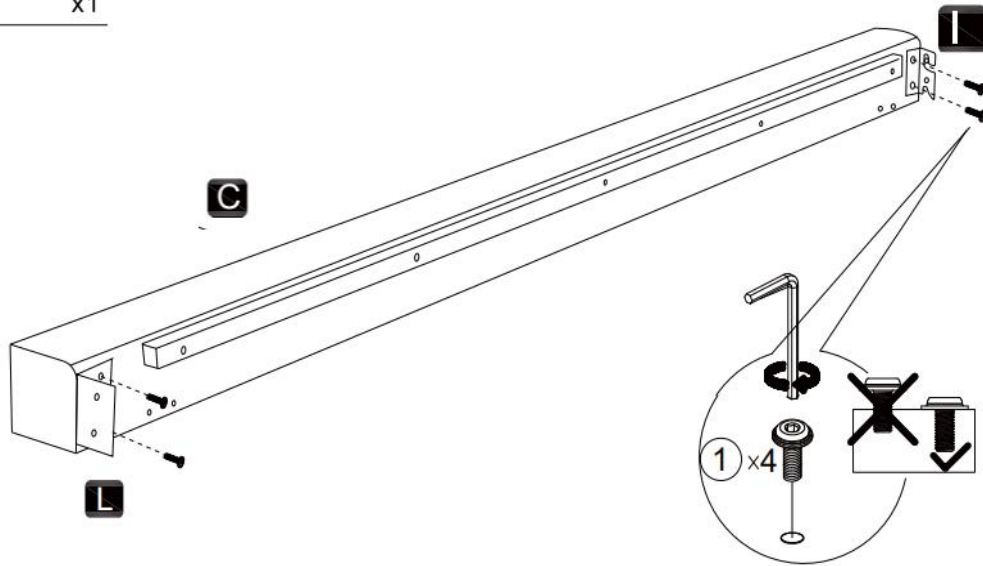

Use bolts (1) to install the left bed side and headboard connection plate (J) and the bed tail foot hanging plate (L) onto both ends of the bed side plate (C), and then tighten them with an Allen wrench (4). Note: Do not tighten the bolt completely.

Step 5

- | | | |
|---|---|-----|
| 1 |  | x12 |
| 4 |  | x1 |

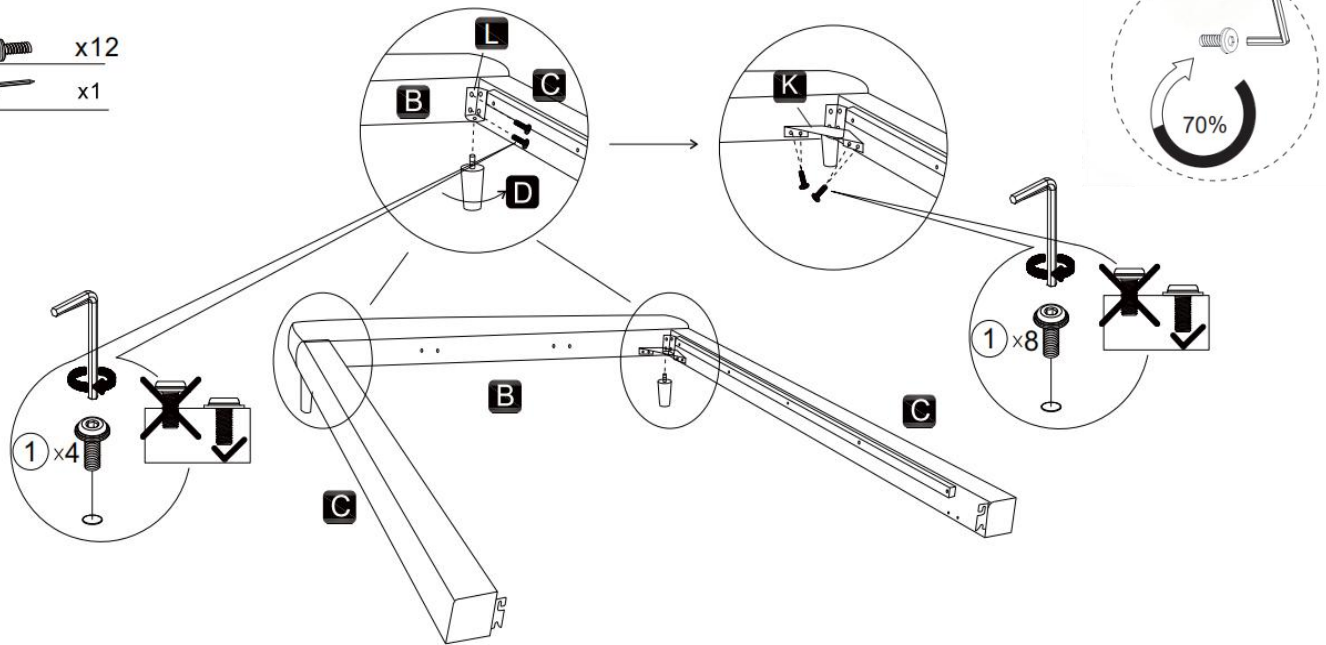

Use bolts (1) to install the two bed side plates (C) onto the bed tail plate (B), and also use bolts (1) to install the bed head, bed tail and bed side reinforcement hardware (K) at the connection points of the bed side and bed tail. Fix the two bed feet (D) onto the bed tail foot hanging plate (L), and tighten them with an Allen wrench (4). Note: Do not tighten the bolt completely.

Step 6

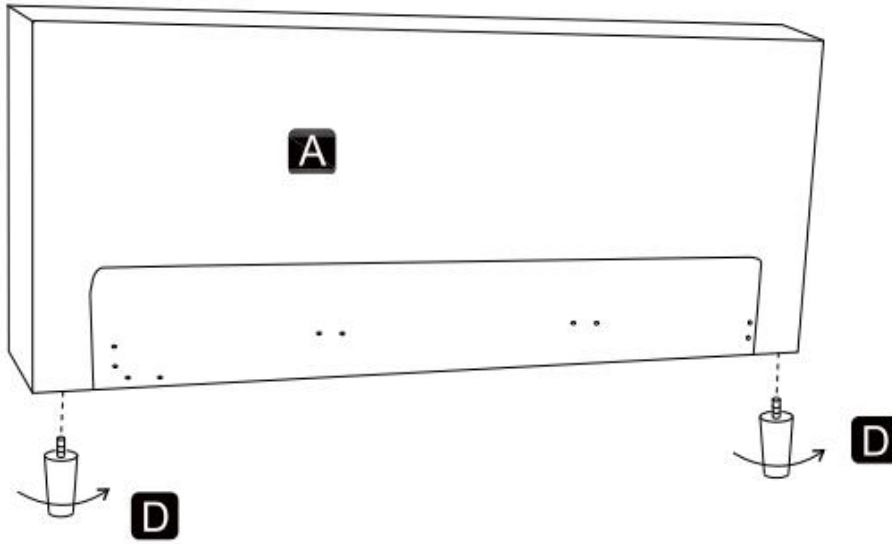

Fix the two bed legs (D) to the head of the bed (A)

Step 7

1		x8
4		x1
2		x4

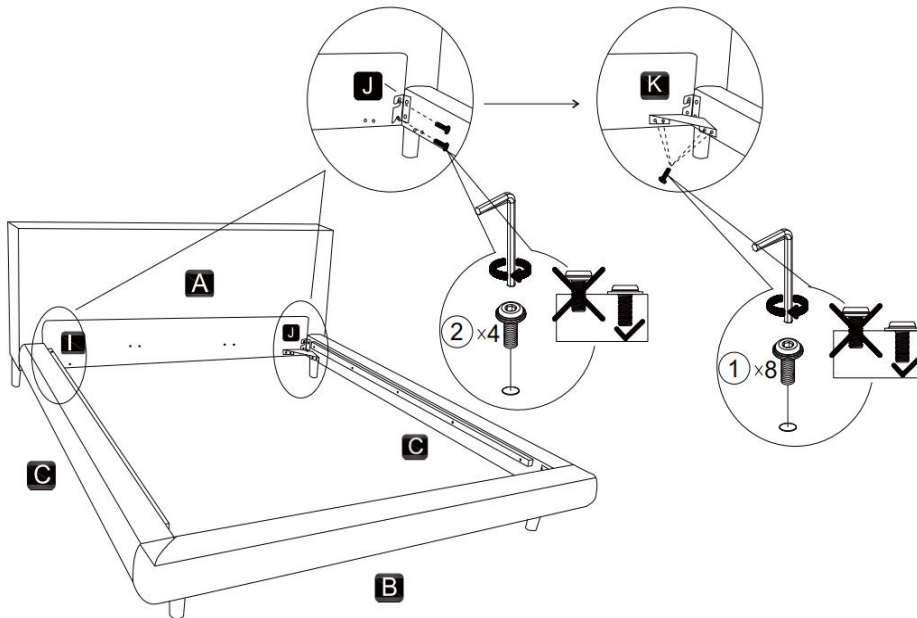

Use bolts (2) to install the two bed side plates (C) onto the headboard (A), and also use bolts (1) to install the headboard, footboard and side reinforcement hardware (K) at the connection points of the bedside and footboard W tail. Fix the two bed feet (D) onto the headboard foot hanging plate (L), and tighten them with an Allen wrench (4). Note: Do not tighten the bolt completely



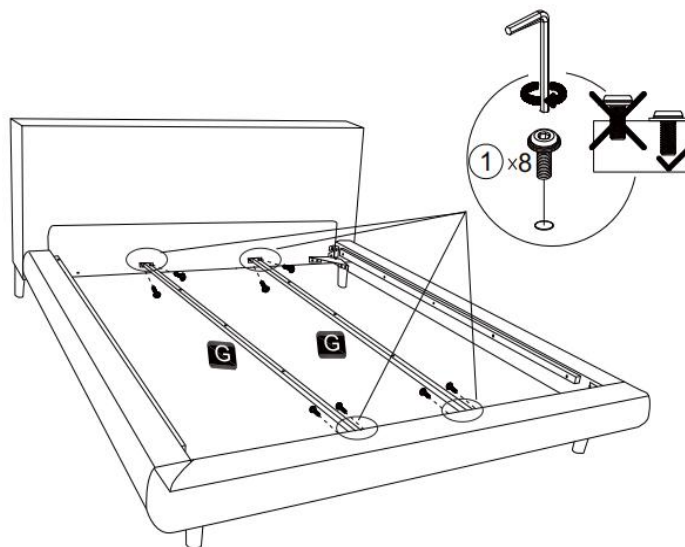

Step 8

1		x8
4		x1



Install the headboard and footboard connecting rod (G) to the middle position between the headboard and footboard with a bolt (1), and tighten it with an Allen wrench (11). Note: Do not tighten the bolt completely.

Step 9

2		x12
4		x1
6		x12
7		x1

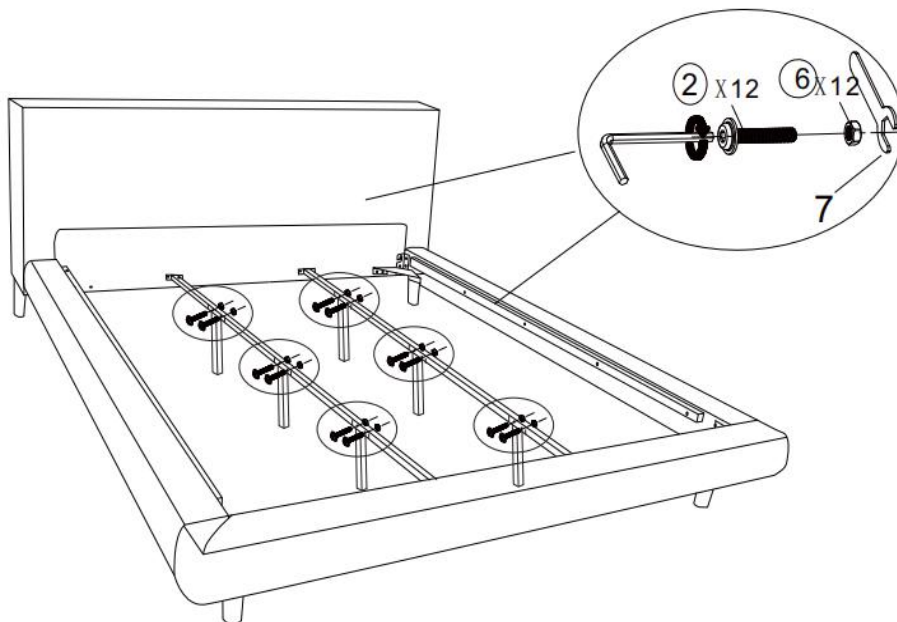

Mount the connection rod support foot (H) to the connection rod (G) between the headboard and footboard using the screw (2), and secure it with the nut (6). Tighten the screw (2) and nut (6) using an internal hexagonal wrench (4) and an open-end wrench (7).

Step 10

5		x8
4		x1

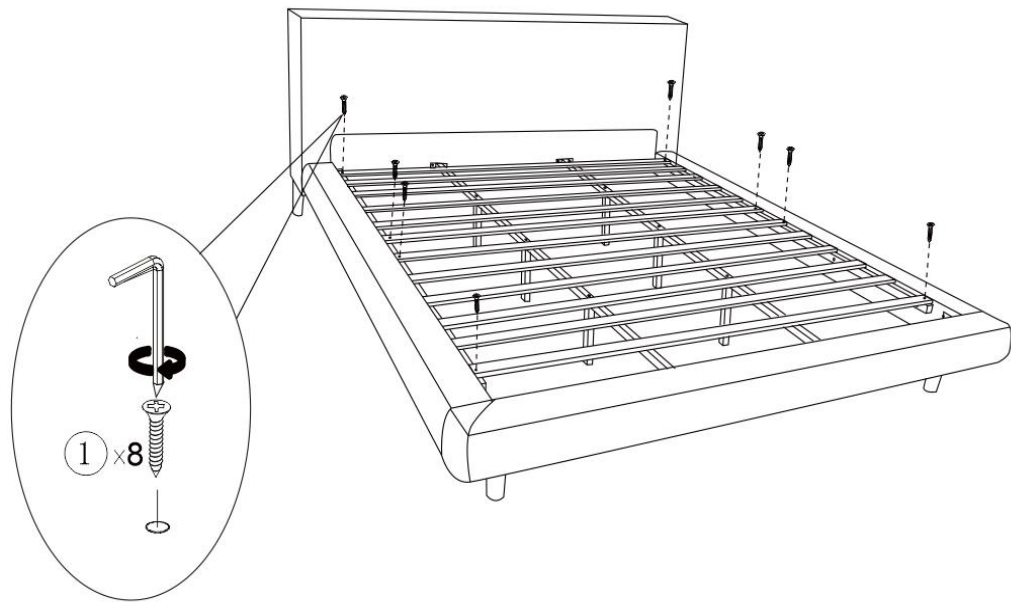

Install the bed board strip (E) onto the rib support strip (F) on the bed side panel with screws (5), and tighten it with an Allen wrench (4)

Step 11

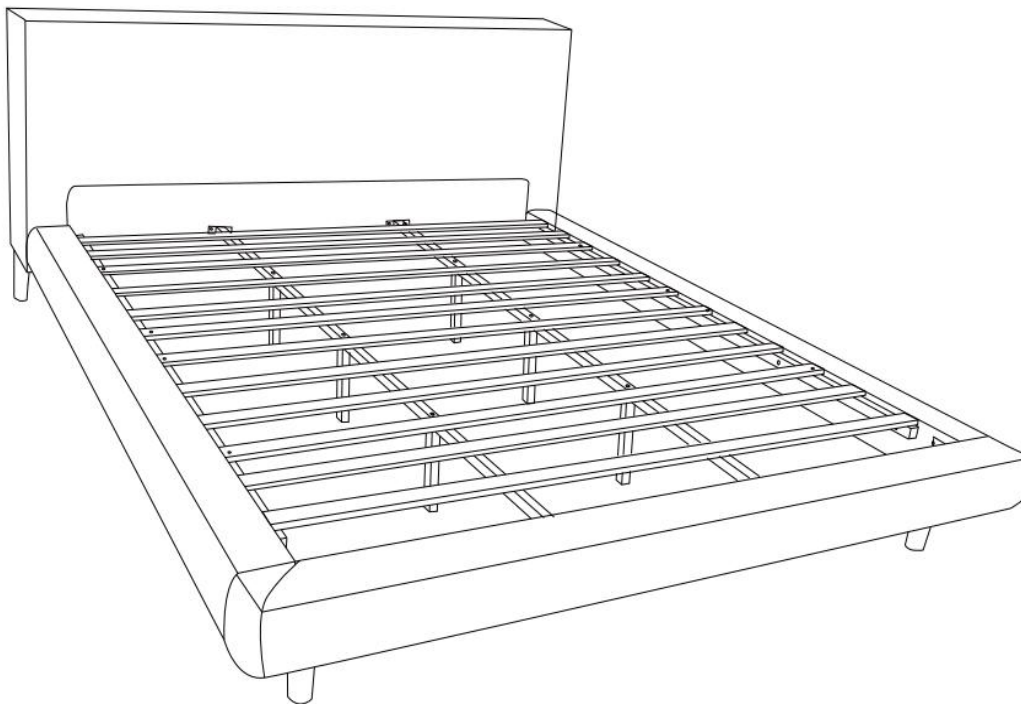

Your bed is ready for use.

Note: After assembly, please tighten all screws. Before using the bed, please check that all components are properly connected and securely fastened.