

Bidet Toilet Seat

User Manual

Enjoy a Spa · Healthy Life

Thank you for choosing us



If you encounter any problems with installation or use, please contact us.

Tips : Please check the accessories included before install.
Actual product may not be same as the drawing

CONTENT

1. User's Guide

1.1 Product Overview	01
1.2 Read First	02
1.3 Specification	03
1.4 Safe Precaution	04
1.5 Disclaimer	05

2. Installation

2.1 Parts and Accessories	06
2.2 Tools for Installation	07
2.3 Installation Steps	08

3. Function Introduce

3.1 Remote Control Description	13
3.2 Knob Description	15
3.3 Indicator Light Description	16

4. Maintenance Instruction

4.1 Notice	17
4.2 Cleaning and Maintenance of Plastic Parts	18
4.3 Cleaning and Maintenance Method of Nozzle	19
4.4 Winter Prevention from Freeze	20

5. Trouble Shooting

6. Warranty

6.1 General Warranty Terms and Conditions	22
6.2 Exemption from Warranty Obligations	24
6.3 About 30days Return Service	25

1. User's Guide

1.1 Product Overview

The pictures in this manual is only for reference, please refer to the actual product.

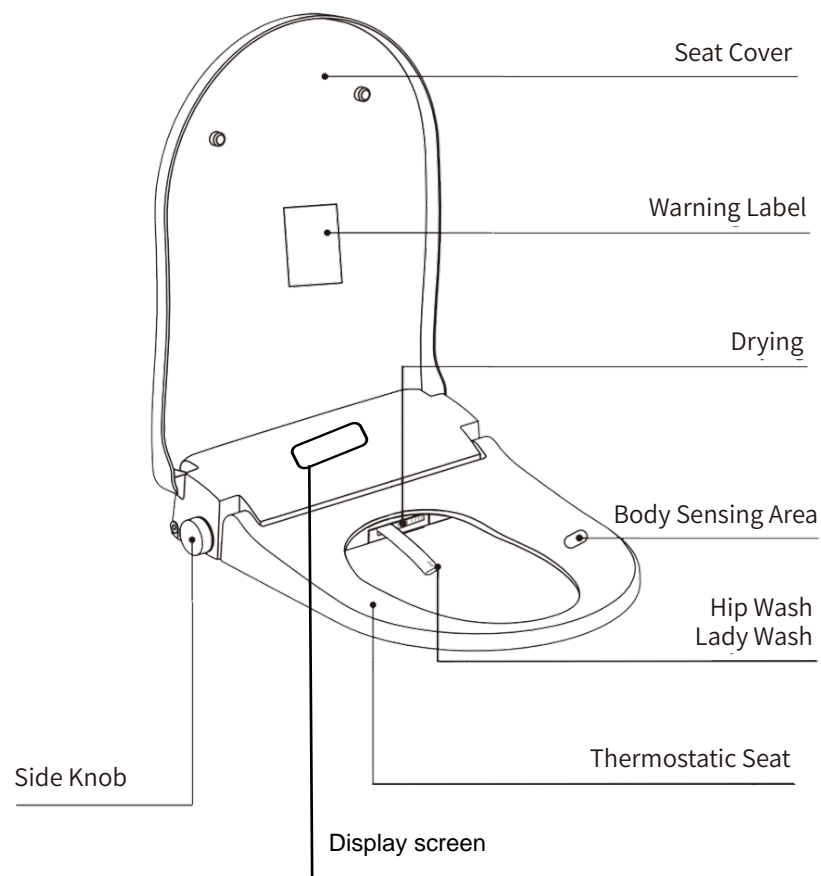

1.2 Read First

Please read the manual thoroughly before installation and use.

- Refer to the actual product appearance for reference.
- The final appearance of the bidet toilet seat may vary based on your home's installation environment.
- Be sure to follow the manual for installation and usage to prevent injury or accidents.

1.3 Specification

Rated Voltage		AC 110V
Rated Frequency		60HZ
Rated Power		1050W (inlet water temperature 15°C, 0.2MPa)
Temperature of the Environment		4°C-40°C
Inlet Water Temperature		5°C-35°C
Water Supply		Angle valve quick coupling
Toilet Type		Floor/wall-mounted
Water Supply Pressure	Lowest Water Pressure	0.015 MPa
	Highest Water Pressure	0.75 MPa
Cleaning	Water Temperature Heating	Instant heating
	Heating Power	600-1800W +7%
	Hip Cleaning Water volume	350-650ml/min
	Lady Cleaning water Volume	350-650ml/min
	Warm Water Temp	34°C-40°C (±2°C)
	Safety Device	Water temperature sensor+temperature fuse
Dryer	Warm Air Temperature	40°C-50°C (±5°C)
	Heat Power	Average about 210W(maximum about 360W)
	Air Speed	>4m/s
	Safety Device	Bimetal fuse switch + thermal fuse
Seat	Seat of Temperature	34°C-40°C(±2°C)
	Heat Power	About 45W
	Safety Device	Seat temp sensor/temperature
Remote Control	Size	7.8(L) x 2.3(W) x 1(H) inches
	Power	Two AAA 1.5 V alkaline batteries
Deodorizer		Silicone pure deodorization (specify configuration)
Night Light Setting		Remote control
Lid		Silent slow fall/automatic flip/manual flip
Power Cord Length		Active length ≥25.4 in
Product size		(L)20.3x(W)15.2x(H)3.9 in
Product weight		About 8 LB

1.4 Safe Precaution



Warnings

- Please unplug the Power Plug when there is thunder.
- Please do not put the product in the water or position it may easily fall into water.
- Do not operate the product which has fallen into or soaked in water, and unplug the Power Plug immediately.
- Socket location should be installed in the water is not easy to get the place, the recommended use of waterproof socket. It is recommended to place the plug on the wall.
- Please do not connect the water pipe with the outlet pipe of the water heater. Please ensure that the water inlet temperature is between 37.4°F-95°F.
- Do not let the sunlight directly irradiate the product, to avoid the product discoloration or bums caused by temperature instability.
- Please do not use industrial water, wastewater, seawater, water and other water sources, otherwise it may cause skin inflammation and other diseases.
- Warnings Do not use banana water, gasoline, potions and detergents, pesticides and hard brush cleaning this product, toilet cleaner, only ceramic body use.
- Please do not use this product in the room with humidity over 90% Rh, the use environment needs to be dry and wet separation.
- The newly decorated house because of residual mud, sand and other damage to the pipeline and human health, before the installation, please, the sewage in the pipeline discharge.
- Please do not exert force or impact on the product, do not stand on the seat ring, toilet cover, do not place heavy objects, do not press, pressure or lean on the toilet cover, so as not to damage the product.



Observe

- Do not allow children to play with this product. · Product should be installed away from heat and ignition sources. Do not supply product with water or power before installation is complete. · The plug should be installed in place. The insert must not be exposed to the air.
- When it is not in use for a long time, please pull out the plug, and drain the water in the filter and product.
- Make sure to unplug the power and close the water valve when in installation, disassembly, repairing and maintenance.
- The new hose assembly included should be used when installing, and the old ones must not be reused.
- If the power cord is damaged, it must be replaced by the manufacturer's repair department or similar professionals to avoid risk.
- The grounding wire of this product must comply with the specified construction method, and the three-level.
- Observe grounding structure must be reliably grounded, otherwise it's forbidden to use this product.
- Persons with physical, perceptual or intellectual impairments or lack of experience and common sense, including children, require the presence of a guardian to use this product.
- This product uses AC110V/60HZpower. To ensure safe use, the socket and the connecting wires must be able to withstand currents of more than 10A.
- After product scrapped, please hand it over to a qualified professional recycling company or institution. Should not be discarded arbitrarily so as not to harm the environment.
- To prevent damage caused by freezing, please keep warm. If the room temperature is lower than 0 Please drain the water to prevent freezing cracking inside the product.



Prohibit

- Prohibit to touch the plug with wet hand, otherwise may cause electric shock.
- Forbid to place the electrified product on its side or upside down, as this may cause fire or burnout.
- Prohibit to disassemble, repair or mod fiction, otherwise may cause fire or get an electric shock.
- Forbid to put lit cigarettes and other incendiary substances into the toilet, as this may cause fire.
- Prohibit to use when the seat or upper cover is not fully opened or closed.
- Forbid to use the power extension or unstable loose outlet, otherwise may cause fire or get an electric shock.
- Prohibit to put fingers or other objects into or blocking warm wind outlet, otherwise may cause scald, electric shock or bum.
- Poured water, detergent or any other liquid is forbidden in the fuselage or power plug, as it may cause fire or get an electric shock.

1.5 Disclaimer

Users must strictly adhere to this Product Installation and Use Manual. Any incidents resulting from incorrect installation or unauthorized operation of the bidet seat will void product liability.

2. Installation

2.1 Parts and Accessories

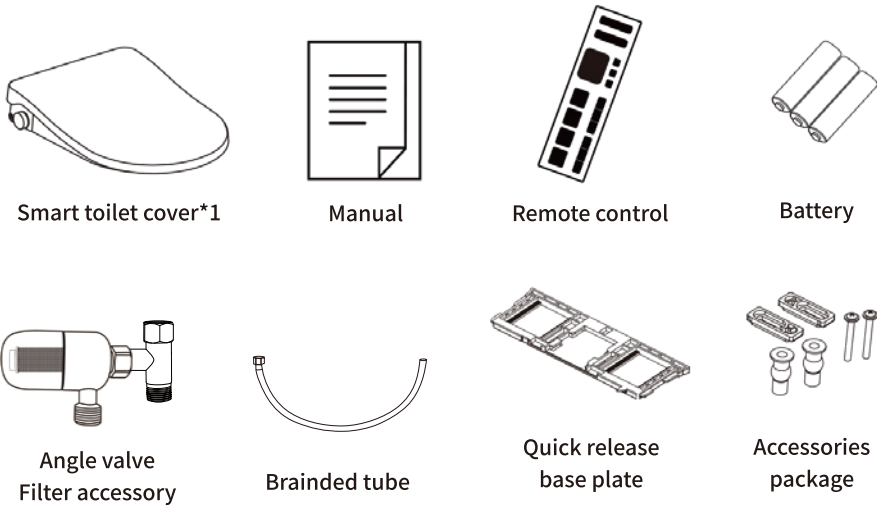

2.2 Tools for Installation

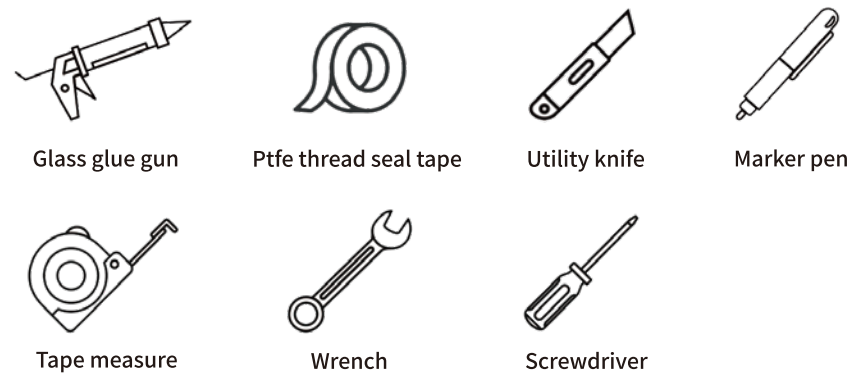

- A. Check the package and prepare all the necessary tools.
- B. Check all kits and components to ensure that nothing has been damaged or missed.
- C. Read the manual carefully before installation, any incorrect installation may cause malfunction.
- D. Choose suitable location and space to install the bidet seat.
 - Avoid bleach, gasoline, and other flammable and explosive materials.
 - Choose an appropriate location for installation.
 - Ensure to shut the water supply valve before install.

2.3 Installation Steps

2.3.1 Install the water inlet assembly.

Step1: Close the angle valve and empty the water tank. Disconnect the water supply line.

Step2: Install the filtering component.

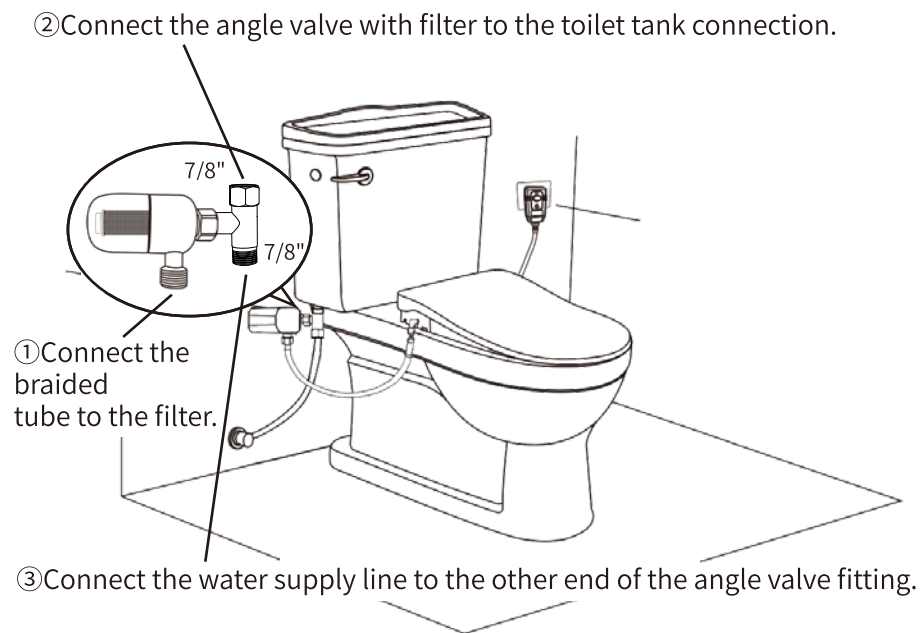

2.3.2 Install the bottom plate.

Step1: Remove the old toilet seat.

Step2: Install the quick installation of the bottom plate.

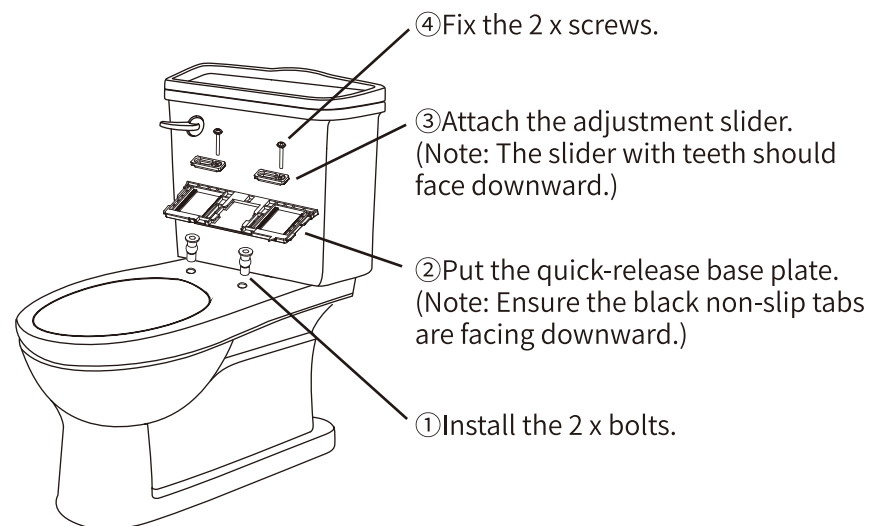

2.3.3 Install the bidet toilet seat.

Step1: Align the slots of the quick-release base plate.

Step2: Push the toilet seat into the mounting slots of the base plate.

(Notice: If you need to adjust the mounting position, press the release button and pull out the bidet seat.)

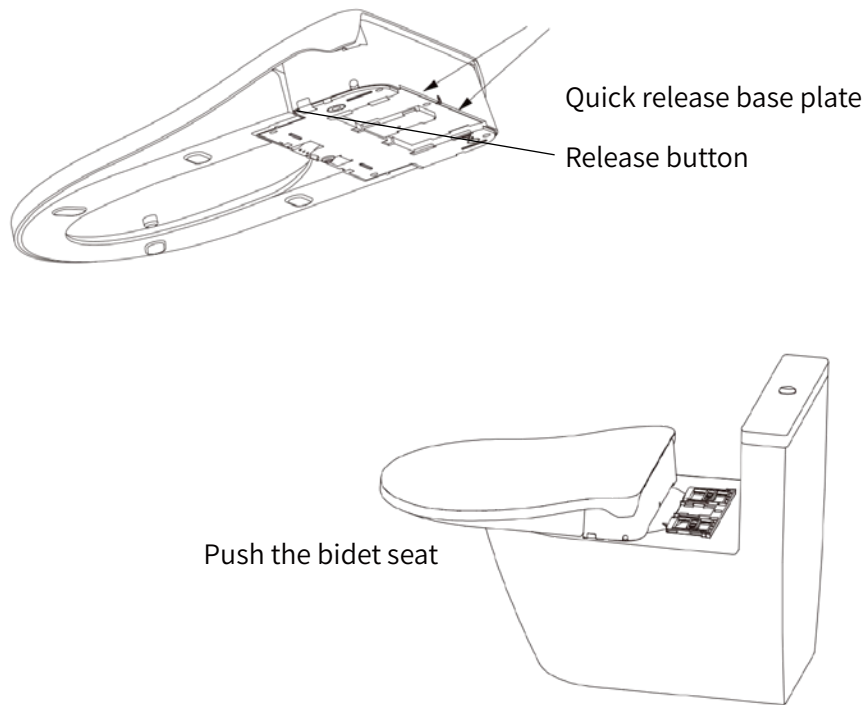

2.3.4 Connect the braided tube.

Step1: Connect the other end of the filter braid tube to the toilet.

Step2: Open the angle valve and check the each connections for leaks.

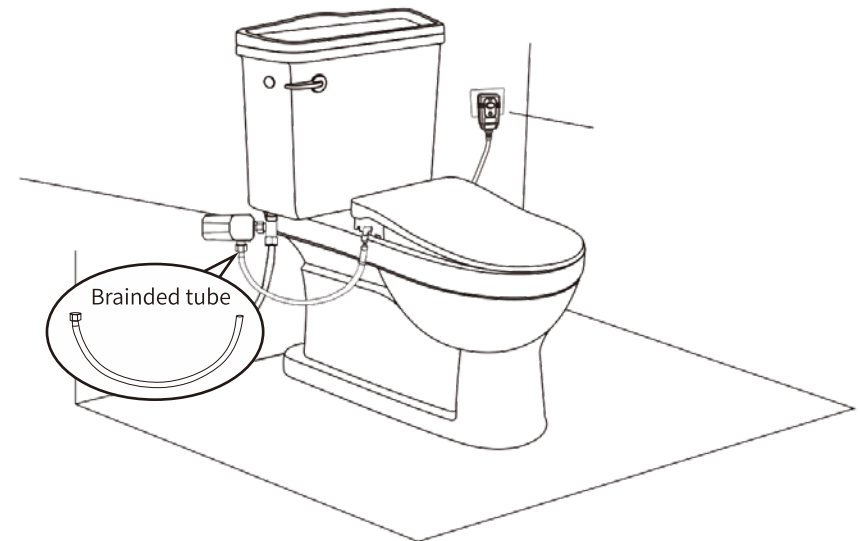

2.3.5 Turn on the power and run the machine.

Connect the power supply and activate the leakage protection switch.

(Notice: After connecting the power, the bidet toilet seat will enter a self-test state. After 30 seconds, the knob indicator will stop flashing and the seat will transition to standby mode.)

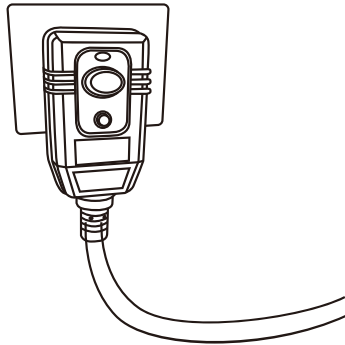

3、Function Introduce

3.1 Remote Control Description

3.1.1 Remote Matching

If the remote control does not operate when batteries are installed, re-match the remote control to the bidet toilet seat.





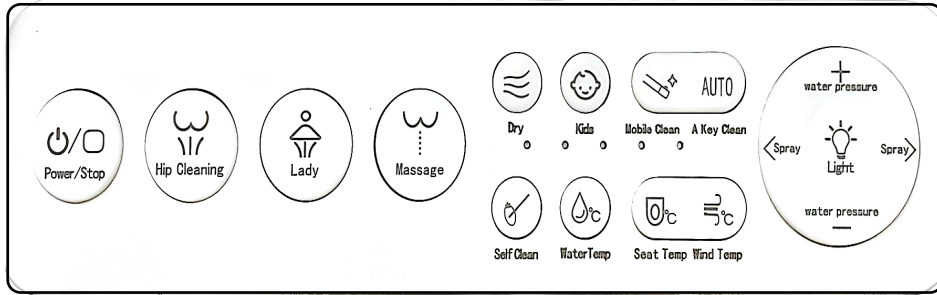

Press and hold the knob for 3 seconds until a beep sounds, and press the stop button on the remote control twice at the same time. You will hear a beep, indicating that the pairing was successful.







3.1.2 Description of Remote Control



Description of Remote Control

Entering the seat state: Seated means that the human body has to enter the seat to the product seat sensor identification area, and the indicator light switch light colorful to yellow, for the state of the seat.

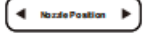
 Power/Stop	Stop the current running command or shut down.
 Hip Cleaning	Hip cleaning / Mobile hip cleaning.
 Lady Cleaning	Lady cleaning / Mobile lady cleaning.
 Massage	Tap to Activate Massage Function.
 Self-Clean	Self-Clean: Cleaning the nozzle.
 Dry	Drying function.
 Light	Toilet interior illumination.

 Kids Mode	Kids: This mode provides lower than water pressure. More suitable for the children use, the knob indicator lights blue.
 Water Temperature	Level 1- Room temperature; Level 2 - 34°C; Level 3 - 37 °C, Level 4 - 40°C
 Seat Temperature	Level 1- Room temperature; Level 2 - 34°C; Level 3 - 37 °C, Level 4 - 40°C
 Wind Temperature	Level 1- Room temperature; Level 2 - 40°C; Level 3 - 45 °C, Level 4 - 50°C
 Nozzle Position	Adjustable for 4 levels
 Water Pressure	Adjustable for 4 levels
AUTO	Sit on the toilet seat and press the auto button on the remote to wash and dry.
Mobile cleaning	Mobile cleaning function for hips.

3.2 Knob Description

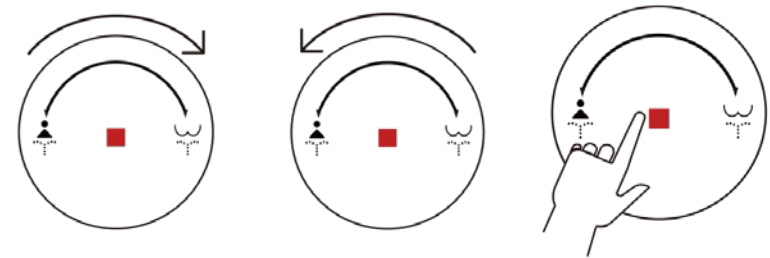

Hip clean

Lady clean

Stop/drying

3.3 Indicator Light Description

- Light blue: Standby
- Yellow: Seated or Children wash
- Dark blue: Lady wash
- Green: Hip clean or Massage
- Red: Drying

4、Maintenance Instruction

4.1 Notice

- To ensure the proper functioning of the product, please clean and maintain it regularly. Before performing maintenance, make sure to turn off the water supply and close the angle valve.
- During maintenance, it is strictly prohibited to flush the product with water.

4.2 Cleaning and Maintenance of Plastic Parts

- When dust or dirt accumulates on the product, wipe it clean with a soft, damp cloth.
- Do not use harsh cleaning agents (e.g., concentrated sulfuric acid, concentrated nitric acid, glacial acetic acid, carbon tetrachloride, chloroform, acetone, butanone, benzene, toluene, cresol, dimethylformamide, methyl ether, soybean oil, 40% nitric acid, concentrated hydrochloric acid, 95% alcohol, gasoline, kerosene, brake fluid, etc.).

4.3 Cleaning and Maintenance Method of Nozzle

With the power on and the seat off, gently pull the nozzle out. If there is dirt in the nozzle hole, use one hand to hold the cleaner while cleaning the nozzle with a toothbrush in the other hand.

*Avoid applying too much force, as this may damage the nozzle.

4.4 Winter Prevention from Freeze

When the product will not be used for an extended period, such as during business trips or travel, please follow these steps:

- Turn off the water supply angle valve and unplug the power supply.

- Disconnect the PE pipe from the water inlet and drain any excess water.

In cold winter conditions, when the product is transported over long distances or stored for an extended period, any remaining water inside may freeze. To prevent damage from freezing, please take the following precautions: Allow the product to sit in a warm room for 30 minutes to naturally defrost before turning the water back on.

5. Trouble Shooting

Phenomenon	Analysis	Treatment
The product do not work	Check that the product is electrified Check if the product socket is loose	Please check the circuit
	Check that the product is in the standby state Check the product for leakage	Press the on/off button of the remote control
	The light of the leakage protection plug is not lighted	Pull the power plug from the socket, plug again later, and press the reset switch of the plug. If it still cannot un please unplug the power plug and.
No water coming out of nozzle	Check if the water is stopped	The water supply will be restored
	Check if the angle valve is closed	Open the angle valve
	Check for blockages in the inlet filter	Clean the filter screen or replace the filter
	Check if the water inlet pipe is bent	Exclude that inlet pipe bends
The spray nozzle is disorderly out of water	Abnormal operation	Re-energize after one minute of unplugging
Cleaning intensity is insufficient	Check if cleaning water pressure is too low	Adjust the water pressure
The cleaning function cannot be used normally	Check that the inlet water filter is blocked	Clean the filter screen or replace the filter
	Check there is a hard object stuck under the seat	Remove hard objects
	Seat human body induction failure	Ask the professionals to repair it
The washer is abnormally dripping	Solenoid valve failure	Ask the professionals to repair it
The water temperature is low	Check if the water temperature is set in the lowest temperture	Adjust the water temperature
Hub temperature is too low/ not heated	Check the temperature is in the closed gear	Adjust the seat temperature
Remote control failure	Check the remote control for water intake	Wipe off the droplets with a dry cloth
The seat cover/ring is falling to fast	Damped slow drop function fails	Ask the professionals to repair it

6. Warranty

6.1 General Warranty Terms and Conditions

This limited warranty applies only to the original purchaser and covers only items supplied by the manufacturer that are found to be defective in materials, workmanship, or factory preparation. It covers parts only; labor costs for removal, replacement, installation, adjustment, maintenance, and repair are not included. This includes any non-manufacturer labor needed for repairs. For services purchased through our website, we offer one-year limited manufacturer's warranty starting from the purchase date. We will replace or repair any part found defective within the warranty period.

The warranty begins on the date of purchase. We will replace or repair any part of the product that we find to be defective in material or workmanship within the warranty period from the date of the original purchase of any part of the product that we find to be the result of a defect in material or workmanship.

6.2 Exemption from warranty obligations

1. Accessories for product are out of warranty and cannot provide a valid invoice for market products.
2. Issues from user neglect of the technical manual, incorrect pin delivery, or improper maintenance.
3. Product failures or damages caused by installation or maintenance by non-company technicians or dealers.
4. Failures or damages due to external factors or user mishandling (eg. misuse, collisions).
5. Damage from natural disasters or force majeure events (eg. fire) affecting the original product.

6.3 30 Days Return Policy

Unused and Unopened Items: A full refund will be issued upon receipt and check of your return.

Defective Items: A full refund will be provided after we confirm the item is defective. Items purchased directly from our website must be returned to us for a refund. We accept returns within 30 days, and products outside this window may still be eligible if they meet specifications. Items within the warranty period may also be covered, but the warranty is non-transferable.