

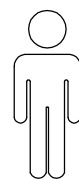



30'



1

P1	P2	P3	P4	H1	H2
					
x 1	x 1	x 4	x 2	x 1	M6 x 40 x 4

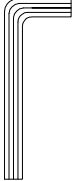
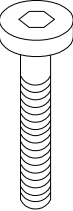
P1

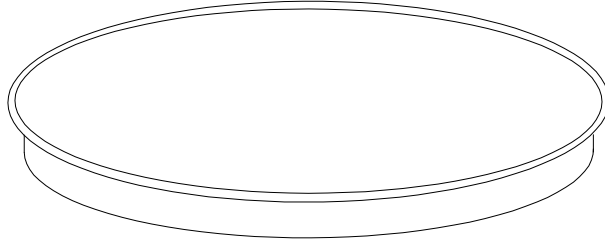

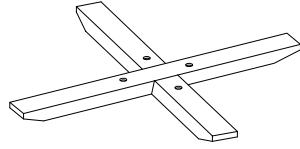

P4 x 2

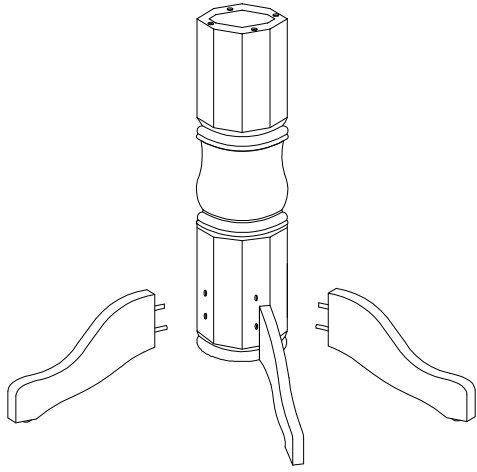

P2

P3 x 4

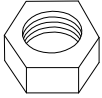

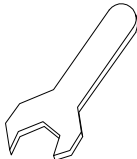
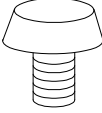
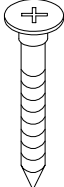

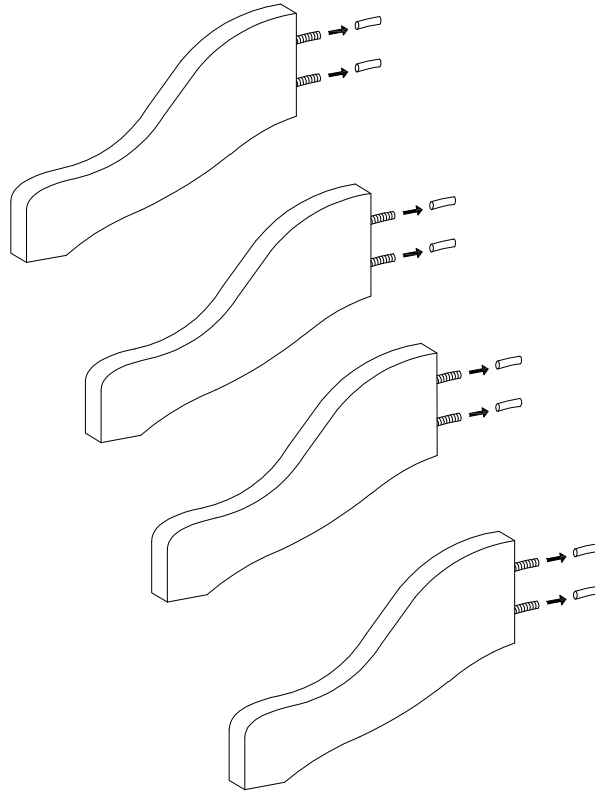

H3	H4	H5	H6	H7	H8
					
x 8	x 8	x 8	x 1	x 4	4 x 32 x 12

!

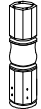

1

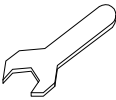
P2  x 1	P3  x 4	H3  x 8	H4  x 8	H5  x 8	H6  x 1
---	---	---	--	---	---

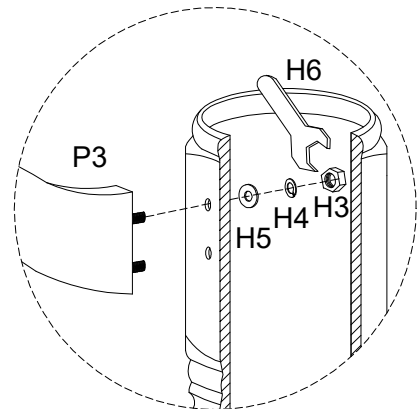
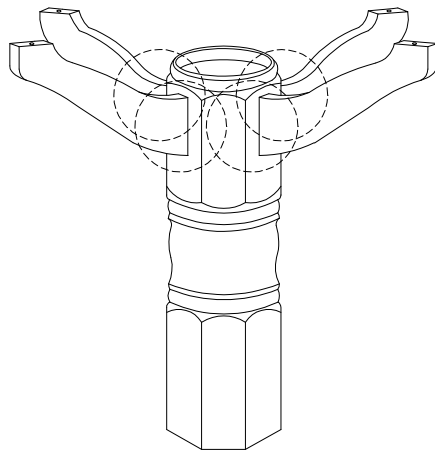

2

H7



x 4

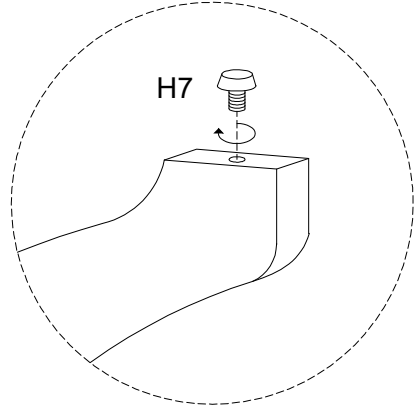
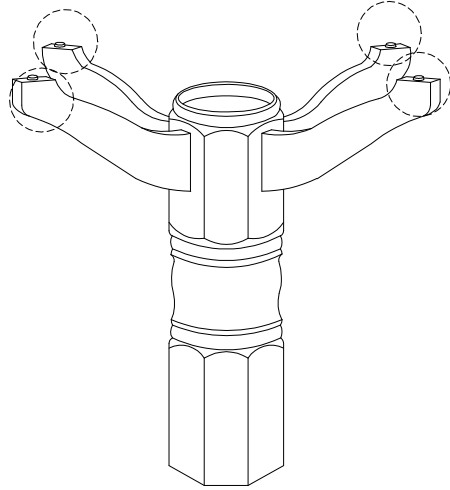

3

P4

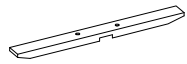

x 2

H1

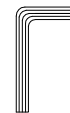

x 1

H2

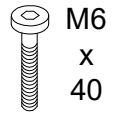

x 4

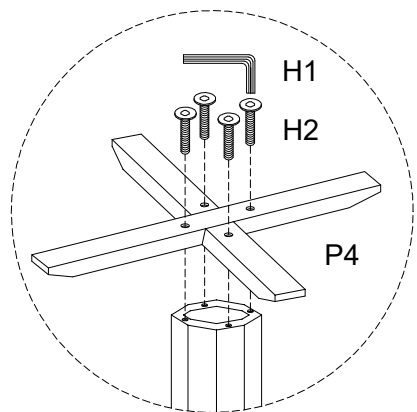
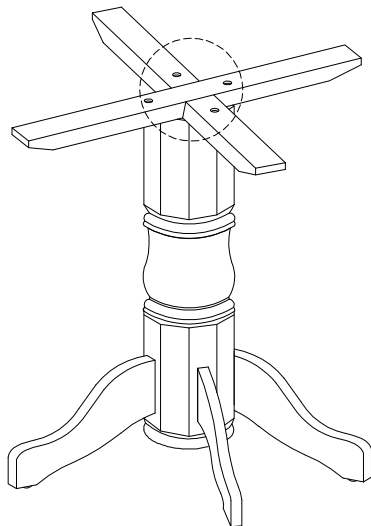

4

P1



x 1

H8

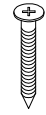

4
x
32
x 12

