











LEXINGTON®

H O M E B R A N D S

ASSEMBLY INSTRUCTIONS

708-883 Side Chair

Part	Hardware List	Quantity
A	 8mm diam. x 100mm Bolt	4 pcs
B	 8mm diam. x 75mm Bolt	4 pcs
C	 8mm diam. x 50mm Bolt	3 pcs
D	 Allen Bolt x 40mm	2 pcs
E	 Screw 5mm x 52mm	6 pcs
F	 Lock Washer o/d 10.5mm	2 pcs
G	 Flat Washer o/d 17 mm	11 pcs
H	 Lock Washer o/d 14mm	11 pcs
I	 Wrench	1 pc
J	 Allen Wrench	1 pc

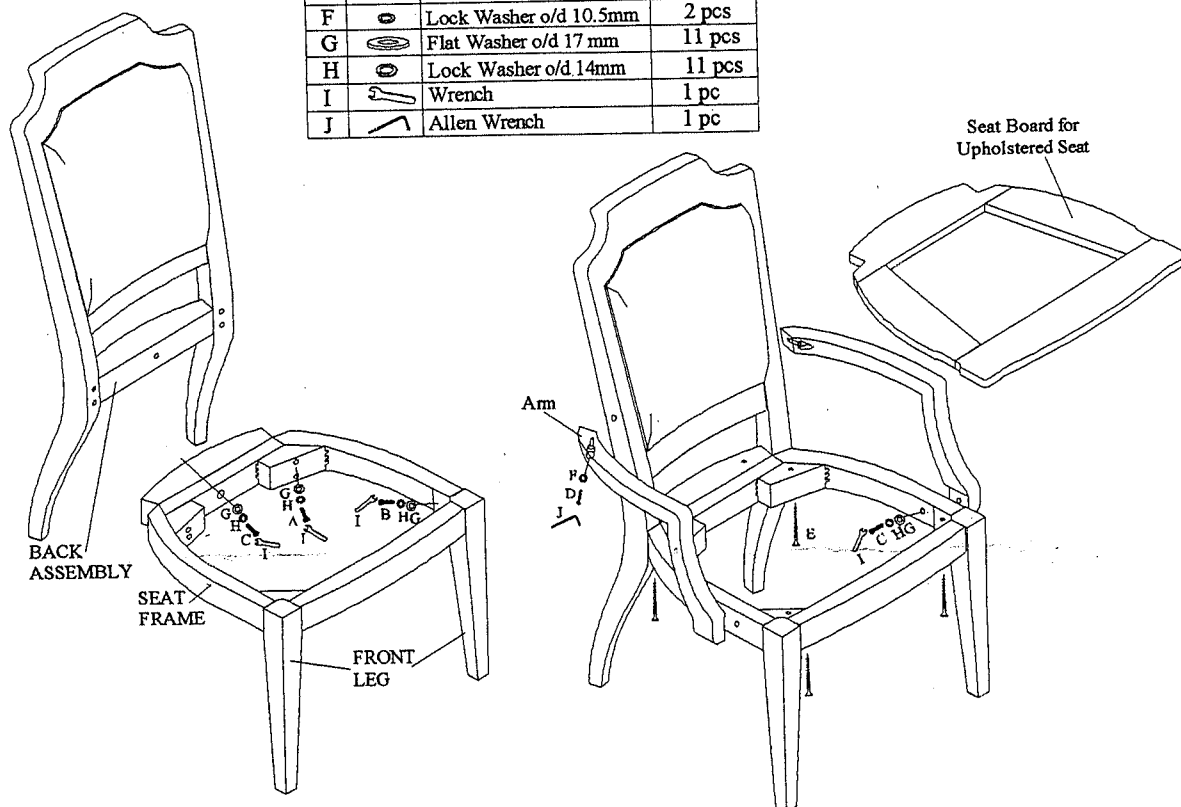

1. Place seat cushion on a clean surface or table.
2. Place Back Assembly front-side up on a non-marring surface. Use locator dowels to align hole in center of Seat Frame back rail with hole in center rail of Back Assembly. Use Spanner Wrench (I) to assemble Back Assembly to Seat Frame with (1) of each: 50 mm Bolt (C), Flat Washer (G), and Lock Washer (H).
3. Use Wrench (G) to attach rear corner blocks of Seat Frame to back legs of Back Assembly with (2) of each: 100 mm Bolts (A), Flat Washers (G), and Lock Washers (H).
4. Insert Front Leg into Seat Frame so that holes in leg align with holes in front corner block. Use Wrench (I) to assemble Front Leg to Seat Frame with (2) of each: 75 mm Bolts (B), Flat Washers (G), and Lock Washers (H). Do not fully tighten bolts. Repeat for other Front Leg.
5. Position arm so that hole at back of arm aligns with back of chair and hole on arm stump aligns with seat frame. Use Allen Wrench (J) to attach arm to chair with (1) Lock Washer 10.5mm (F) and (1) Allen Bolt 40mm (D) at back of chair. Do not fully tighten bolt. Use Spanner Wrench (I) to attach arm stump to chair with (1) of each: Flat Washer (G), Lock Washer (H), and 50mm Bolt (C). Repeat for other arm and then tighten all bolts.
6. After making sure all bolts are attached and hand tightened, place chair in upright position.
7. Level chair by following "Chair Leveling Instructions" on separate sheet.
8. Make sure chair is level and then tighten all bolts completely using supplied wrench.
9. Remove plastic cover on upholstered seat cushion. Use a Phillips screwdriver to install seat on frame with (1) Screw (E) through bottom of each corner block and into Seat Board of upholstered seat.