











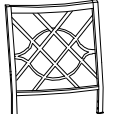
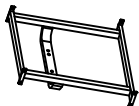

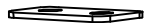

F13BN132

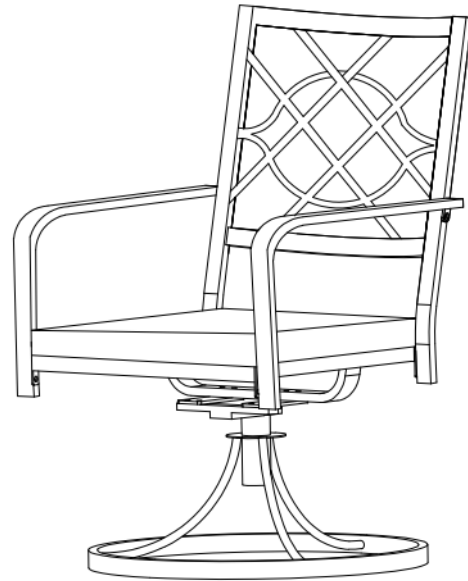
CHAIR

DO THIS TWO TIMES

A		Left Arm Rest	1PC
B		Right Arm Rest	1PC
C		Seat Back	1PC
D		Seat Base	1PC
E		Leg Base	1PC
F		Plate	2PCS
G	 M6*12	M6*12 Screw	10PCS
H	 M8*35	M8*35 Screw	4PCS
I	 M6	M6 Washer	10PCS



J	 M8	M8 Washer	4PCS
K		Spring Washer	4PCS
L		Nut	4PCS
M	 M6	Allen Key	1PC
N	 M8	Wrench	1PC
O		Cushion	1PC

- ① Attach seat base (D) to leg base (E) using M8*35 screw (H) with M8 washer (J), plate (F), spring washer (K) and nut (L).

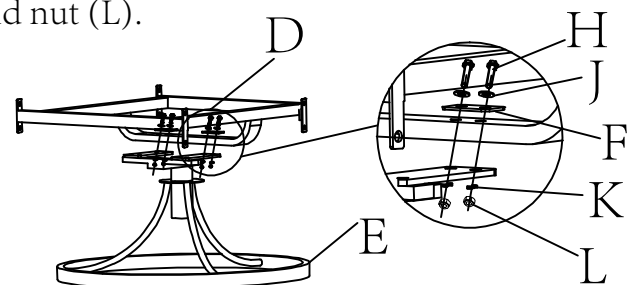

Loose attach all connections at the beginning, adjust alignments then fully tighten all joints

F13BN132

CHAIR

DO THIS TWO TIMES

- ② Attach right arm rest (B) to seat base (D) using M6*12 screw(G) and M6 washer (I) as shown.

Attach left arm rest (A) to seat base (D) using M6*12 screw(G) and M6 washer (I) as shown.

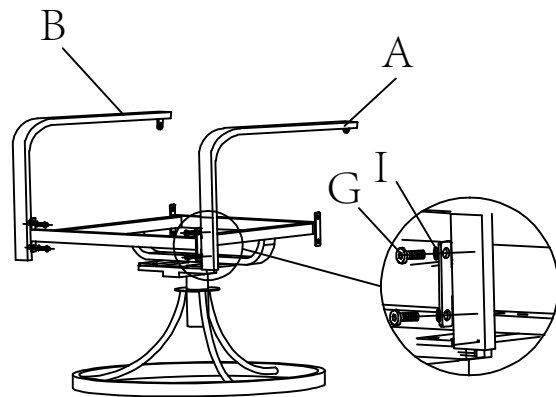

- ③ Attach right arm rest (B) to seat back (C) using M6*12 screw (G) and M6 washer (I) as shown
 Attach left arm rest (A) to seat back (C) using M6*12 screw (G) and M6 washer(I) as shown.

Attach seat back (C) to seat base(D) using M6*12 screw (G) and M6 washer (I) as shown.

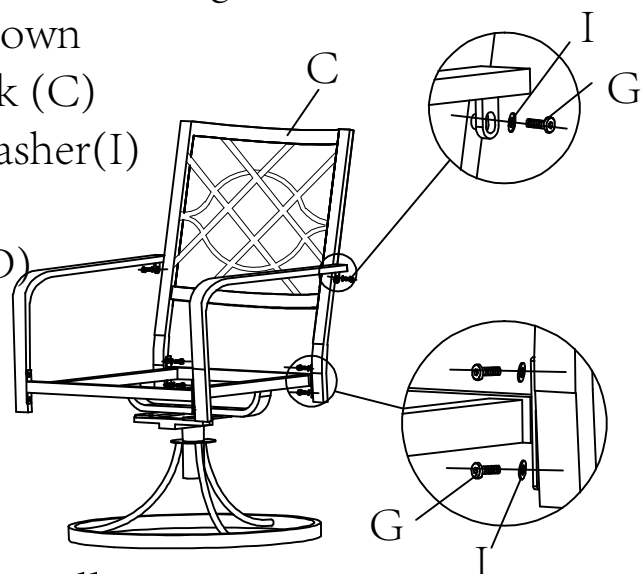

- ④ Checking all screw and tighten all screws.

Then put on cushion.

Enjoy your chair!

