

# ASSEMBLY INSTRUCTIONS

---

## TOOLS REQUIRED

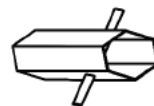

Socket Wrench

(Included)

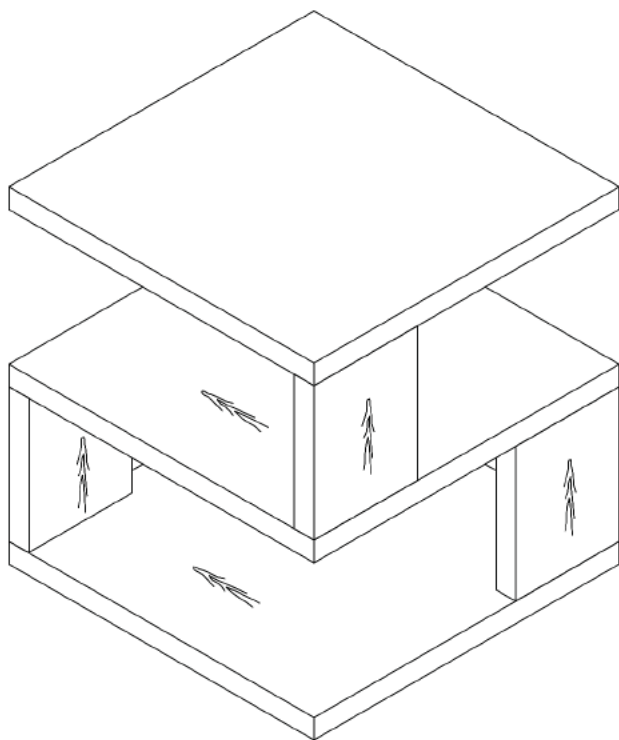

2 - Persons  
Recommended

## ASSEMBLY RATING



EASY ————— DIFFICULT

The Assembly Rating is a 5-point system showing the level of effort needed to assemble a specific product.



## **CHECK BEFORE STARTING**

### **Are you missing anything?**

Double-check all parts, hardware and accessories listed on Page 6 are accounted for.

### **Check out our Quick Tips!**

We recommend reviewing the pre-assembly handouts. Even experts need a refresher now and then!

### **Should we send any replacements?**

Are there any irregularities or flaws in the parts? We can send replacements!

### **Prep Time!**

Please review the assembly instructions and all diagrams prior to assembling. Arrange parts as recommended on Page 7 and group identical hardware together to make assembling easier.

# PRE ASSEMBLY INTRODUCTION

We understand building ready-to-assemble furniture can be a challenging experience for some. To help avoid confusion, we have provided some helpful tips that may speed up the process.

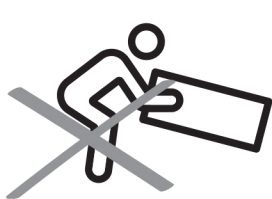

## Teamwork

ALWAYS have at least two people to help with transporting and assembling the product to avoid potential injury and/or damage.



## Suitable Location

Assembling near the area of the intended location is highly recommended.



## Sufficient Space

Make sure you have enough space to move around during the assembly.



## Avoid Scratches

Use cardboard, blankets or a carpeted area while assembling furniture to prevent scratches.



## Flat Surface

Make sure the furniture rests on a flat and level surface with each leg evenly touching the floor.

# ASSEMBLY AND CARE ADVICE



**FAILURE TO FOLLOW THE GUIDELINES BELOW MAY  
RESULT IN INJURY AND/OR PROPERTY DAMAGE.**



Position each part correctly  
and insert screws or bolts into  
their respective holes.

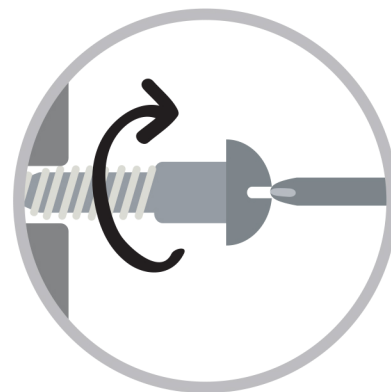

Turn clockwise to tighten and  
only tighten when step is  
completed or when instructed  
to do so.



Use the appropriate hand tools  
or power tools for assembly.  
Select steps, such as tightening  
screws and/or bolts, may require  
hand tools to avoid causing  
damage during assembly.



Save the instructions and store  
any supplied tools for later  
maintenance.



After two weeks, check and  
tighten any loose hardware and  
repeat again every six months  
thereafter.

**IT IS THE USER'S RESPONSIBILITY TO MAINTAIN THE FURNITURE. THE HARDWARE MAY LOOSEN OVER TIME AND MAY CAUSE THE FURNITURE TO BE WOBBLY AND UNABLE TO SUPPORT ITS INTENDED WEIGHT CAPACITY. THIS MAY LEAD TO COLLAPSE AND MAY CAUSE SERIOUS INJURY.**

# END TABLE



- Please keep instructions for future reference.
- Check the quantity and irregularity of parts and hardware before you start.

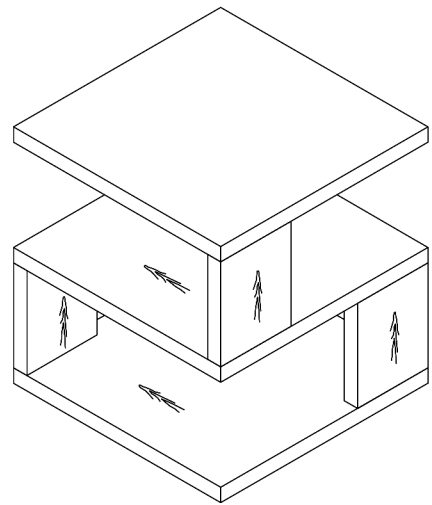

## PARTS

#1 1pc

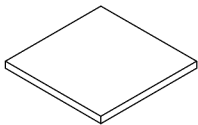

Wooden Top

#2 1pc

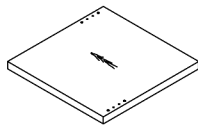

Mid board

#3 1pc

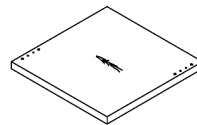

bottom board

#4 4pcs



Post board

## HARDWARE

#A 8pcs



Rod 1/4"x11-3/4"

#B 16pcs



Set Screw  $\varnothing 6 \times 30$

#C 8pcs



Nut M6

#D 8pcs



Flat Washer

#E 1pc

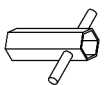

Socket Wrench M6

#F 4pcs

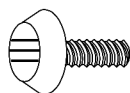

Adjustable Foot  
M6 x 16

# ASSEMBLY INSTRUCTIONS

1

Exploded View

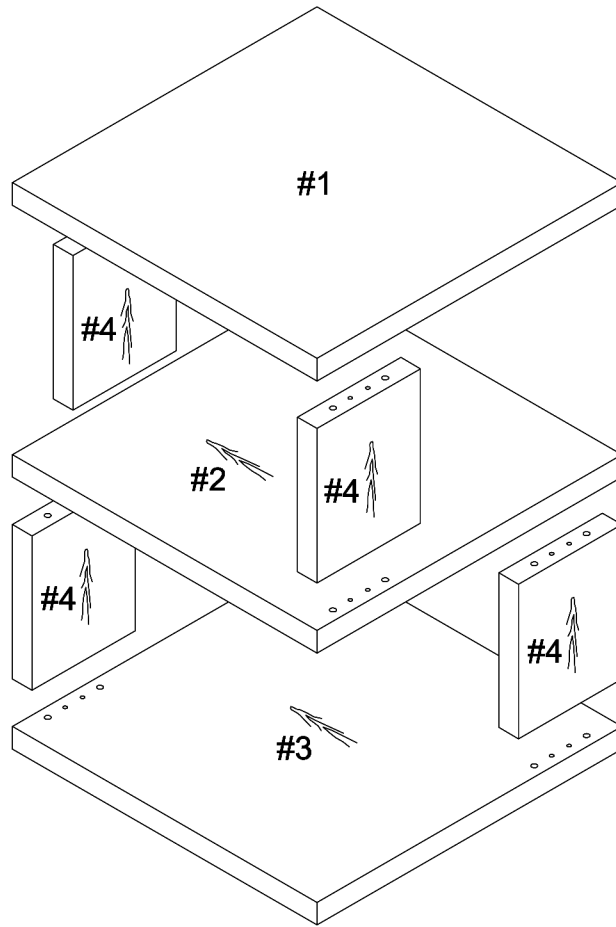

2

Part #1 x 1pc

Part #4 x 2pcs

Hardware #A x 4pcs

Hardware #B x 4pcs

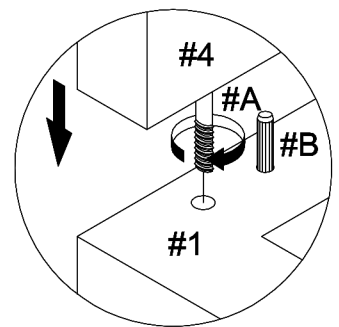
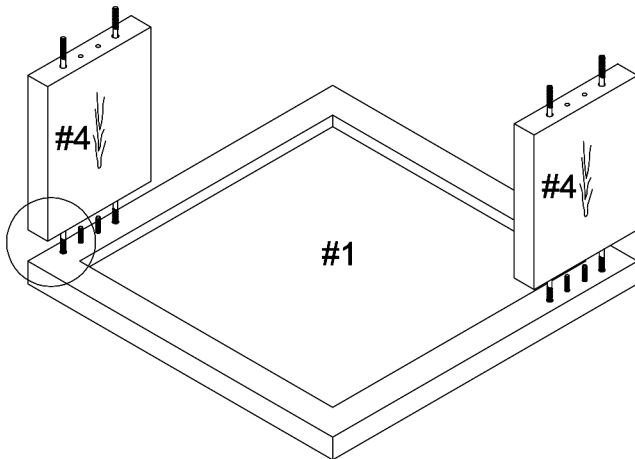

Attach dowels (#B) and rods (#A) to top (#1), then align post boards (#4) to top (#1).

# ASSEMBLY INSTRUCTIONS

## 3

- Part #2 x 1pc
- Part #4 x 2pcs
- Hardware #B x 4pcs
- Hardware #C x 4pcs
- Hardware #D x 4pcs

Insert dowels (#B) to post boards (#4), then align mid board (#2) to post boards (#4). Secure by using hex nuts (#C) with washers (#D).

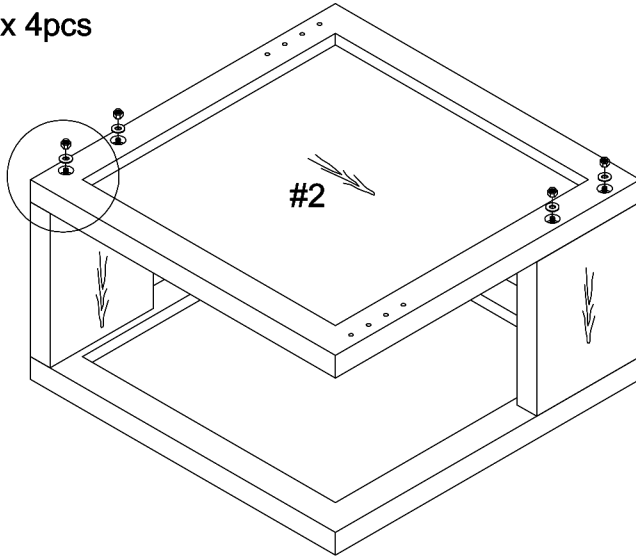

3-1

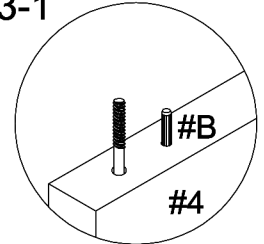

3-2

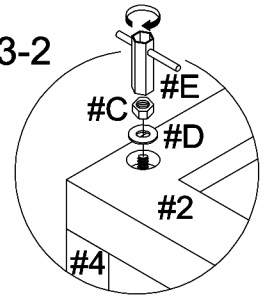

## 4

- Part #2 x 1pc
- Part #4 x 2pcs
- Hardware #A x 4pcs
- Hardware #B x 4pcs

Attach rods (#A) and dowels (#B) to mid board (#2), then align post boards (#4) to the mid board (#2).

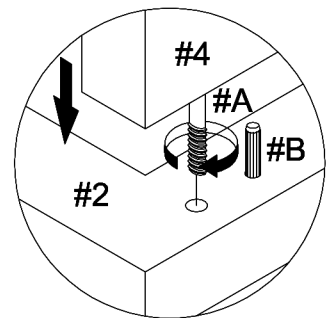
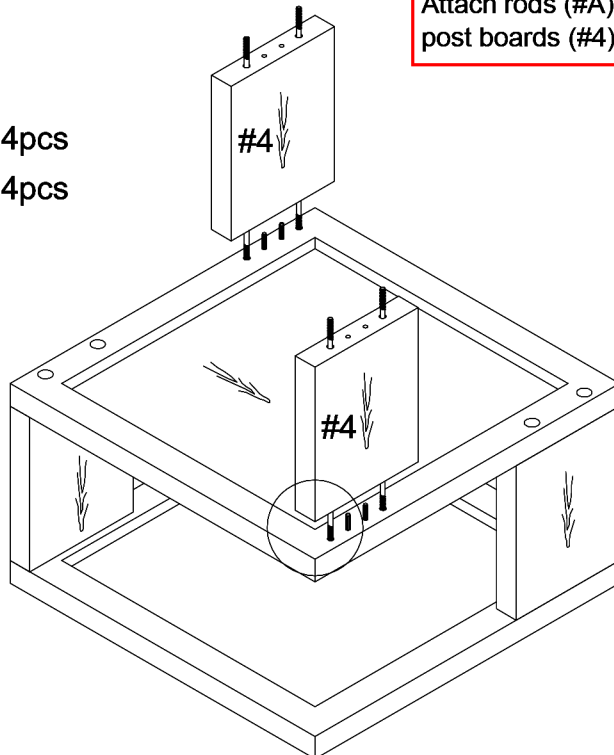

# ASSEMBLY INSTRUCTIONS

Insert dowels (#B) to the post boards (#4), then align bottom board (#3) to post boards (#4). Secure by using hex nuts (#C) with washers (#D). Attach and adjust adjustable feet (#F) to bottom board (#3).

## 5

- Part #3 x 1pc
- Part #4 x 2pcs
- Hardware #B x 4pcs
- Hardware #C x 4pcs
- Hardware #D x 4pcs
- Hardware #F x 4pcs

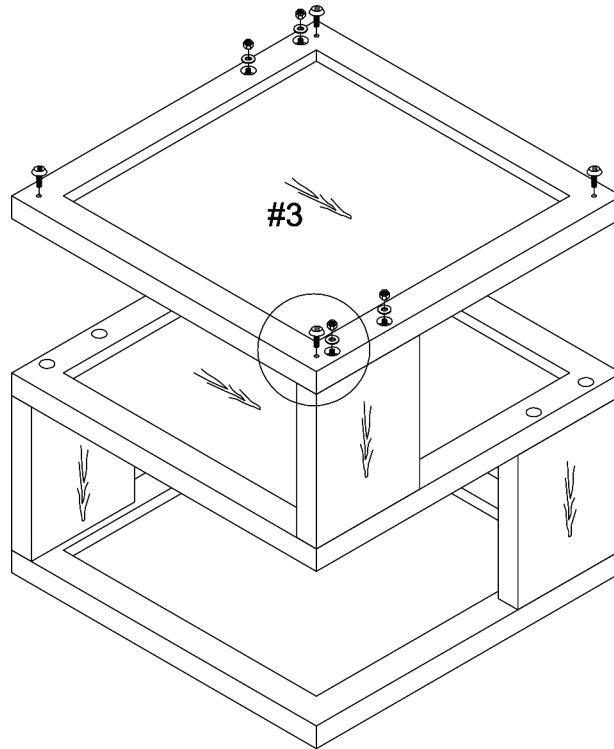

### 5-1

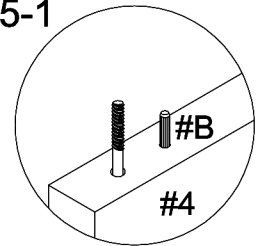

### 5-2

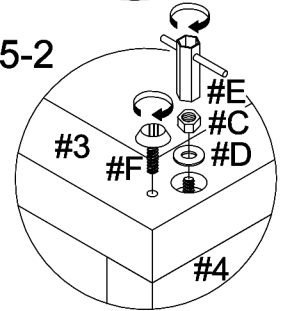

## 6

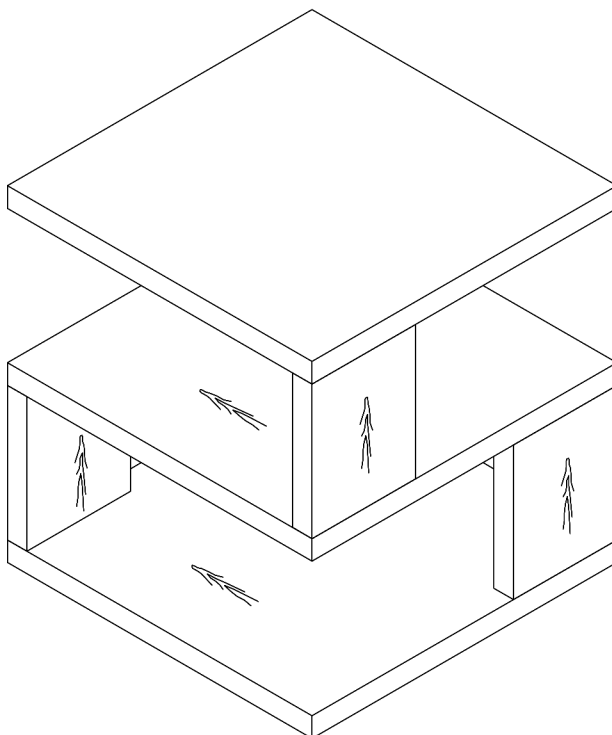

## ASSEMBLY COMPLETED



Please ensure the furniture rests on an even and flat surface. If the product wobbles or feels loose, double-check all bolts and/or screws are properly tightened and secured.



### Keep this handy!

Please retain this instruction manual and any order-related information for future reference.