

SKU:W00391

THE BED ASSEMBLY INSTRUCTIONS

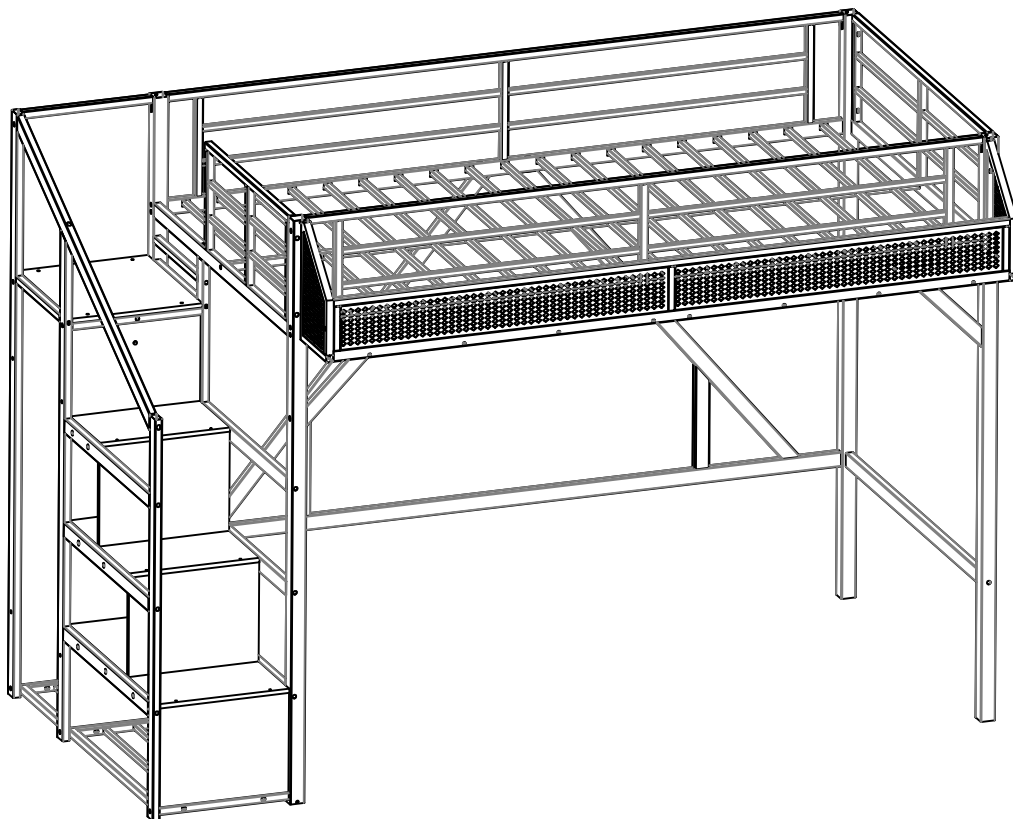

Please use the screws correctly according to the instructions. Thank you.

SAFETY WARNINGS AND GENERAL NOTES:







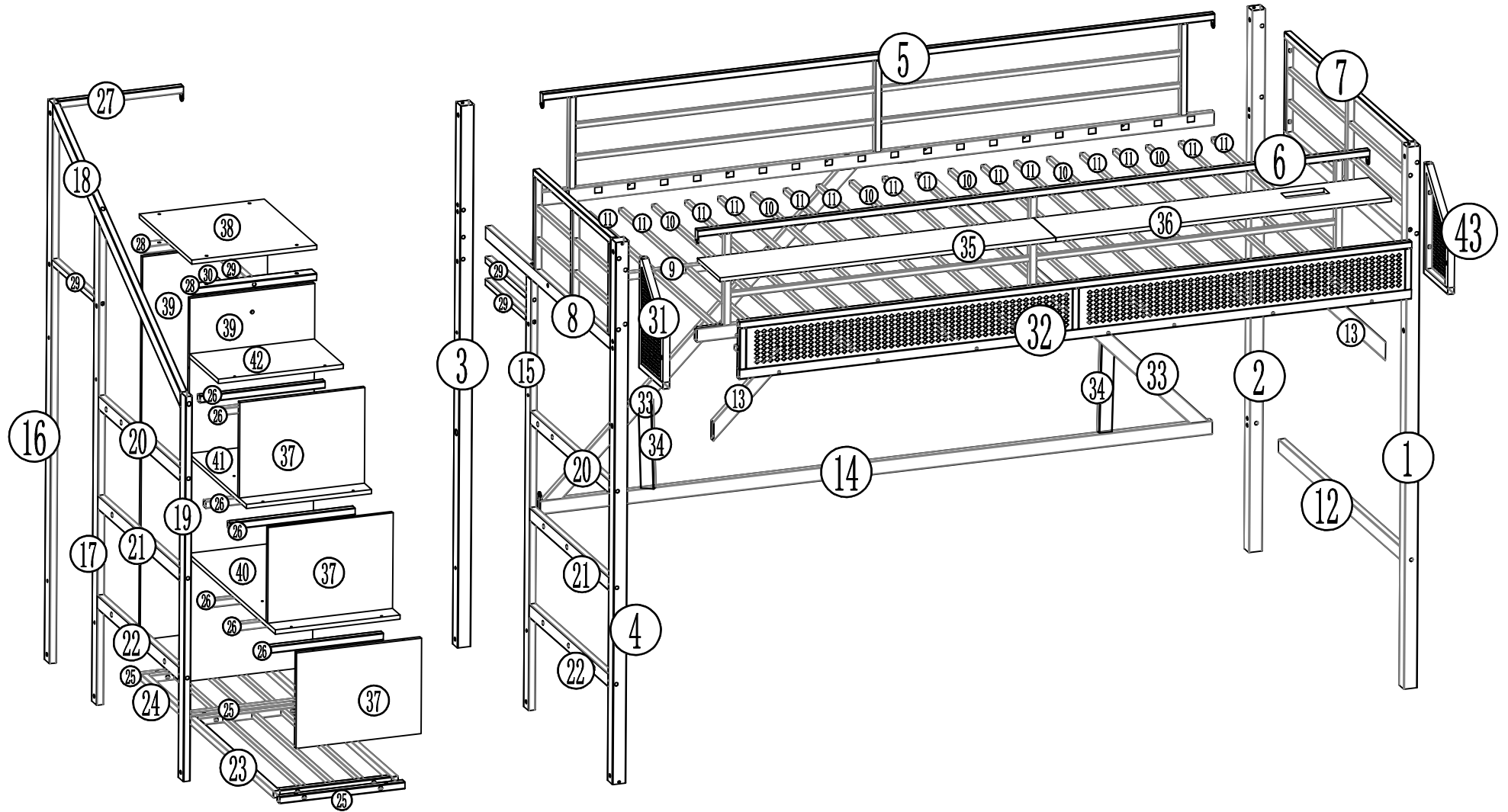



























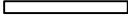



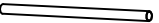

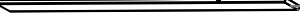
1. Follow the information on the warnings on the bunk bed end structure and on the carton. Do not remove the warning label from the bed.
2. Always use the recommended size mattress on mattress support, or both, to help prevent the likelihood of entrapment or falls.
3. Do not allow children under 6 years of age to use the upper bunk.
4. Periodically check and ensure the guardrail, ladder and other components are in their proper position, free from damage, and all connectors are tight.
5. Do not allow horseplay on or under beds.
6. Always prohibit jumping on the bed.
7. Prohibit more than one person on upper bunk.
8. Always use the ladder for entering and leaving the upper bunk.
9. Do not use substitute parts. Contact the manufacturer or dealer for replacement parts.
10. Use of a night-tight may provide added safety precaution for a child using the upper bunk.
11. Always use guardrails on both long sides of the upper bunk.
12. If the bunk bed will be placed next to a wall, the guardrail that runs the full length of the bed should be placed against the wall to prevent entrapment between the bed and the wall.
The use of water or sleep flotation mattresses is prohibited.
13. **STRANGULATION HAZARD**-Never attach or hang items to any part of the bunk bed that are not designed for use with the bed; for example, but not limited to, hooks, belts and jump ropes.
14. Keep these instructions for future reference.
15. We recommend assembling your bunk bed on the shipping carton to protect your floor or carpet.
16. Be certain all staples are out of the box before beginning assembly on the shipping carton.
17. USE ONLY MATTRESSES WHICH ARE AS THE TABLE BELOW ON UPPER AND ON LOWER BUNKS.
Up bed (bunk bed and tribed included)

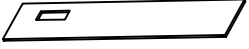
Mattress size	Length	Width	Thickness
TWIN Standard	74"-75"	38"-39"	6"max
18. SURFACE OF MATTRESS MUST BE AT LEAST 5"(127MM) BELOW THE UPPER EDGE OF GUARDRAILS.
19. Replacement Parts:
Replacement Parts, including additional guardrails, may be obtained from any of our (Shenzhen Yuefeng Zhiqi Technology Co., Ltd) dealers.



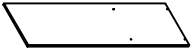
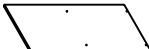







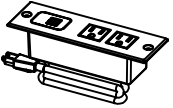





Bed parts view

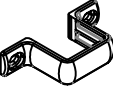

Part List

 1-1pcs	 2-1pcs	 3-1pcs	 4-1pcs	 5-1pcs	 6-1pcs		
 7-1pcs	 8-1pcs	 9-1pcs	 10-6pcs	 11-13pcs	 12-1pcs		
 13-2pcs	 14-1pcs	 15-1pcs	 16-1pcs	 17-1pcs	 18-1pcs		
 19-1pcs	 20-2pcs	 21-2pcs	 22-2pcs	 23-1pcs	 24-1pcs		
 25-3pcs	 26-7pcs	 27-1pcs	 28-2pcs	 29-4pcs	 30-1pcs		
 31-1pcs	 32-1pcs	 33-2pcs	 34-2pcs	 35-1pcs	 36-1pcs		
 37-3pcs	 38-1pcs	 39-2pcs	 40-1pcs	 41-1pcs	 42-1pcs	 43-1pcs	 44-8pcs

Hardware List

 P Socket 1pcs	 A	 B	 C	 D	 E	 F	 G 4*35-22PCS	 H 4*50-6PCS	 O	 M	 K 38PCS	 U 2PCS
 Q Light strips 1pcs	4*10 2PCS	8*15 3PCS	8*35 35PCS	8*55 64PCS	6*30 28PCS	8*15-23PCS				 L=4MM		 T 4PCS
										 L=5MM		

Step 1

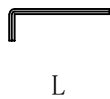
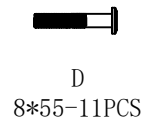
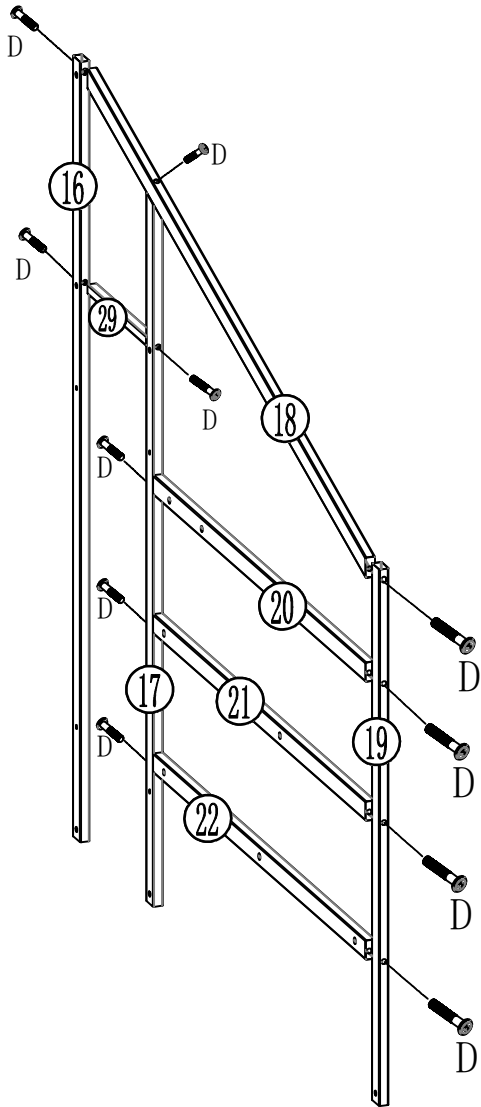

Step 2

Pay attention to the installation position of this hole

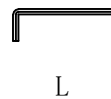
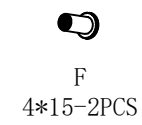
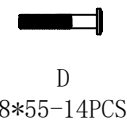
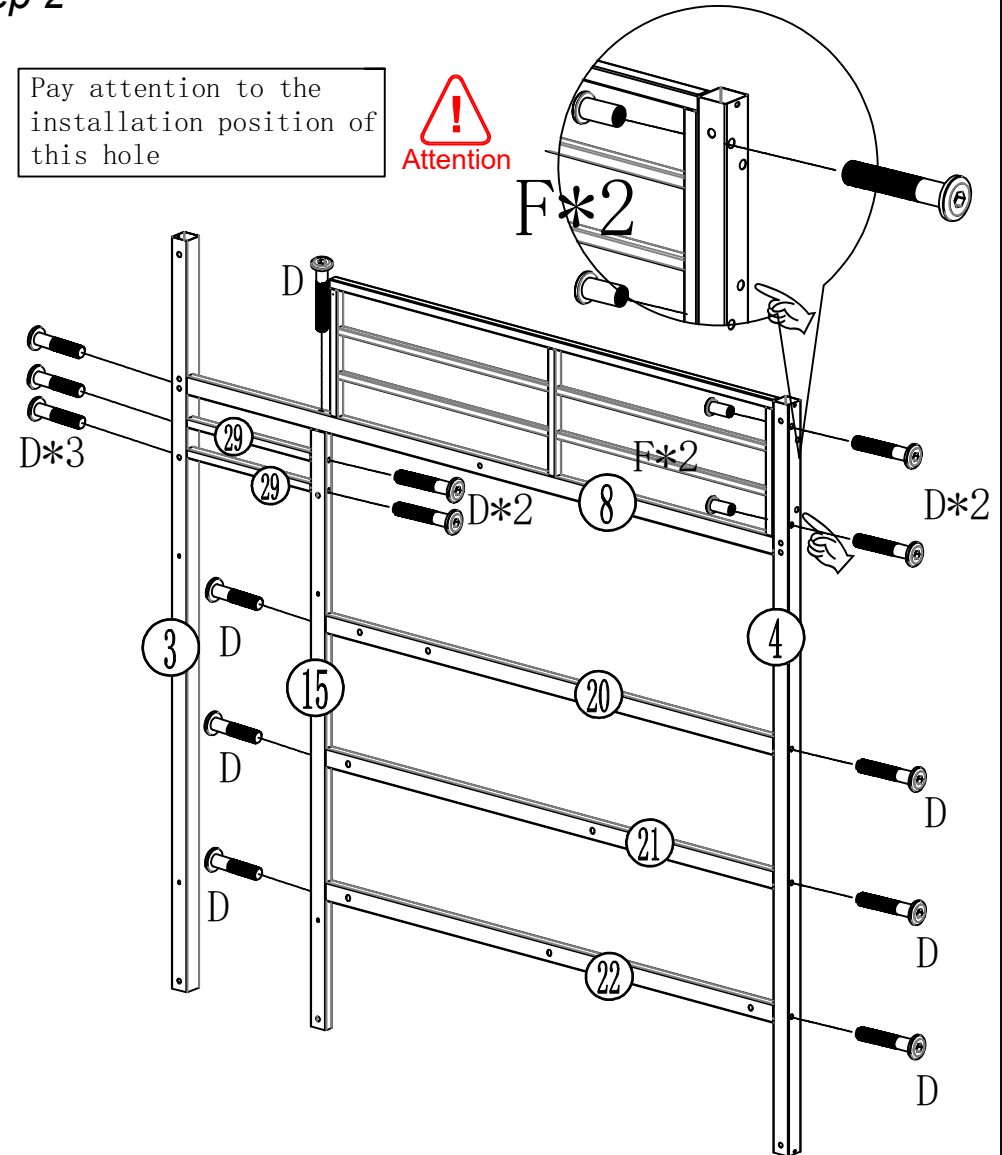

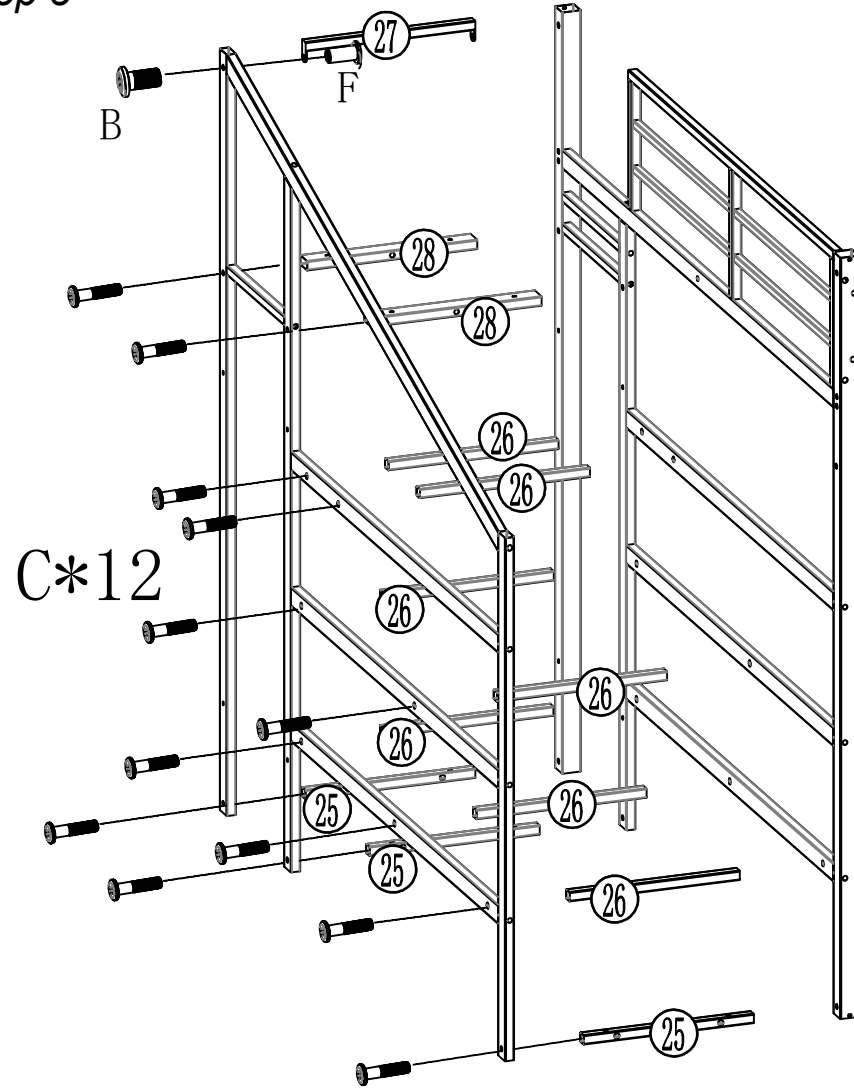

Step 3



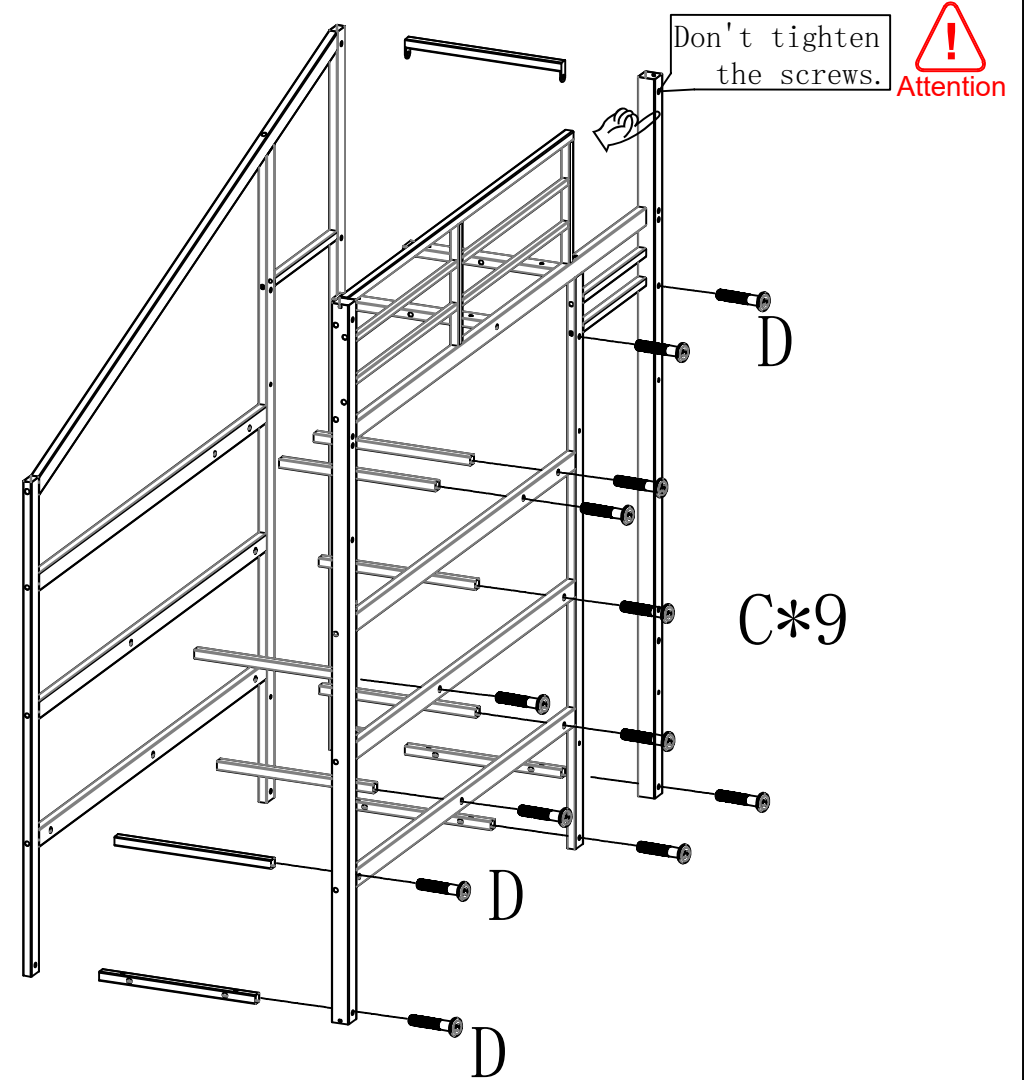

Step 4





F
4*15-1PCS



C
8*35
12PCS

B
8*15-1PCS



L

C
8*35
9PCS

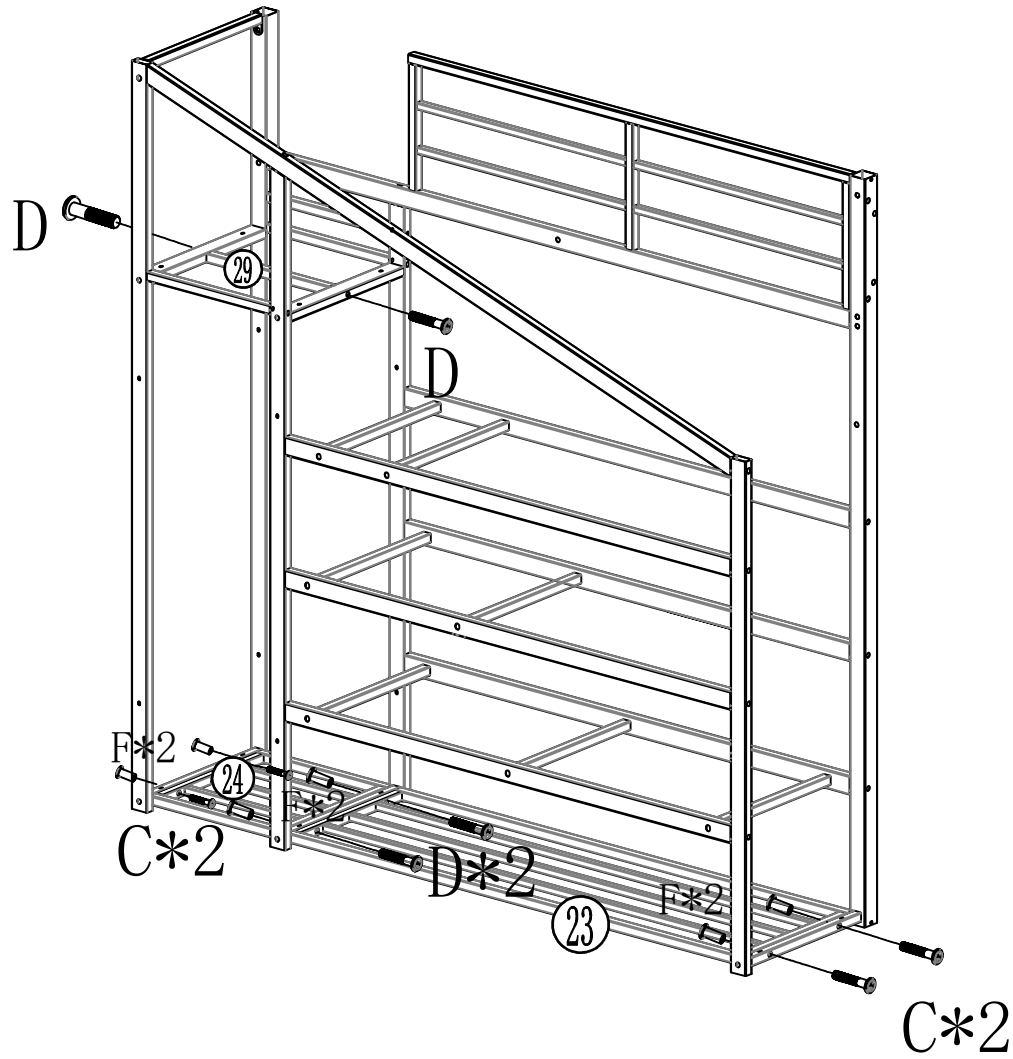

D
8*55-3PCS

L

Step 5

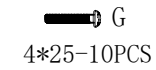
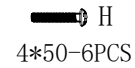
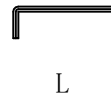
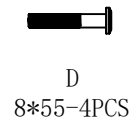
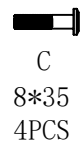
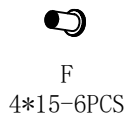
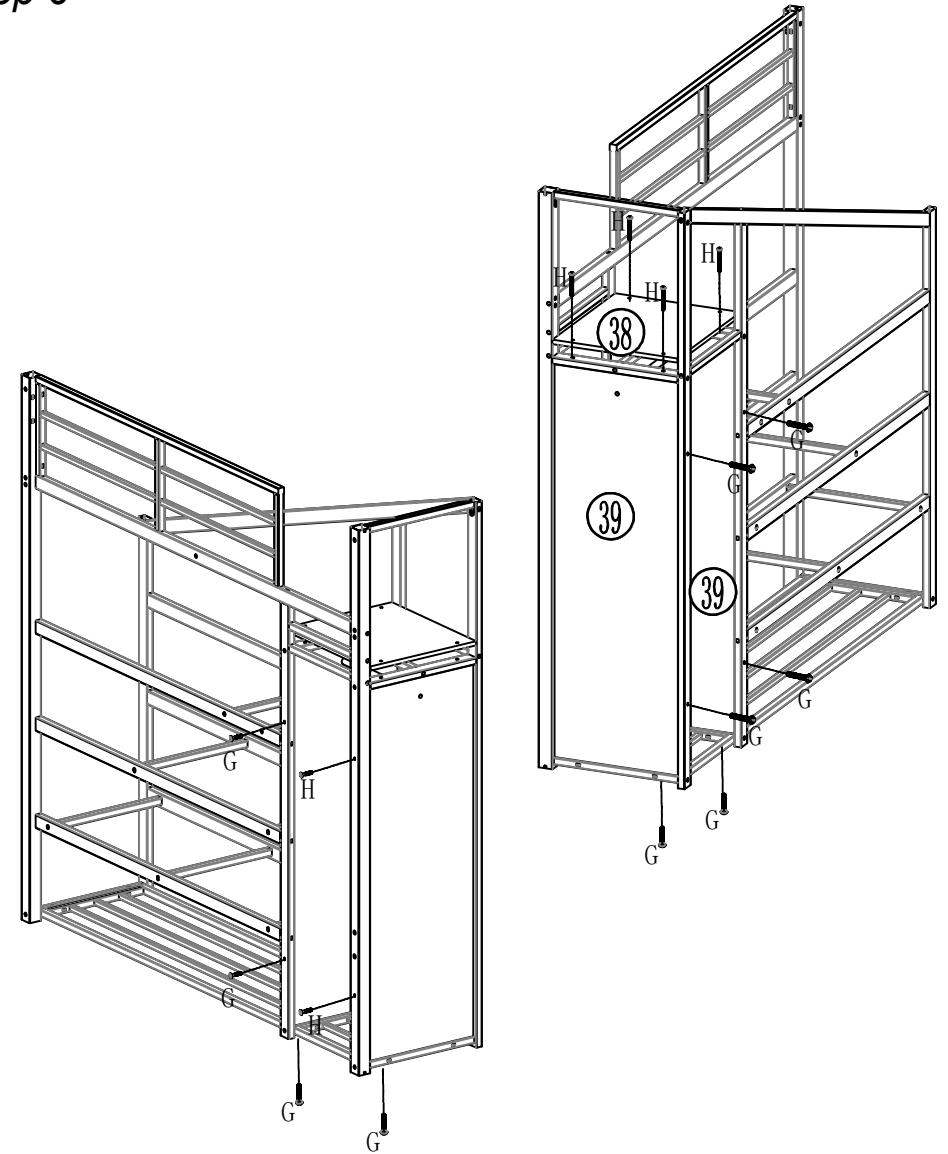

Step 6



Step 7

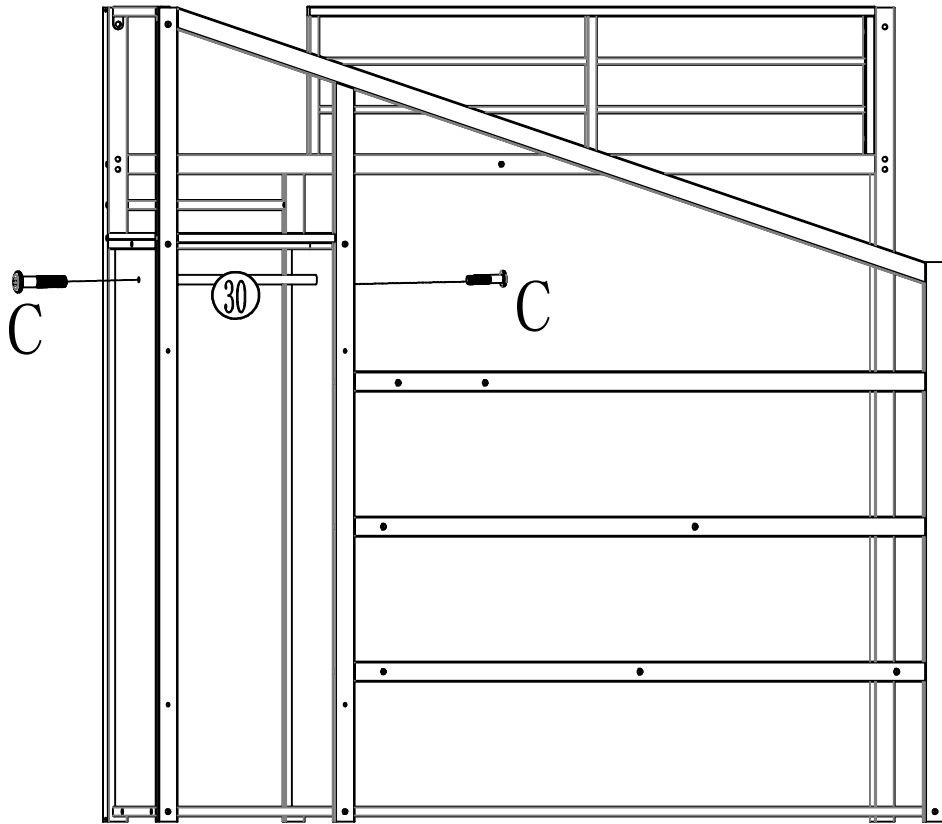

C
8*35
2PCS



L

Step 8

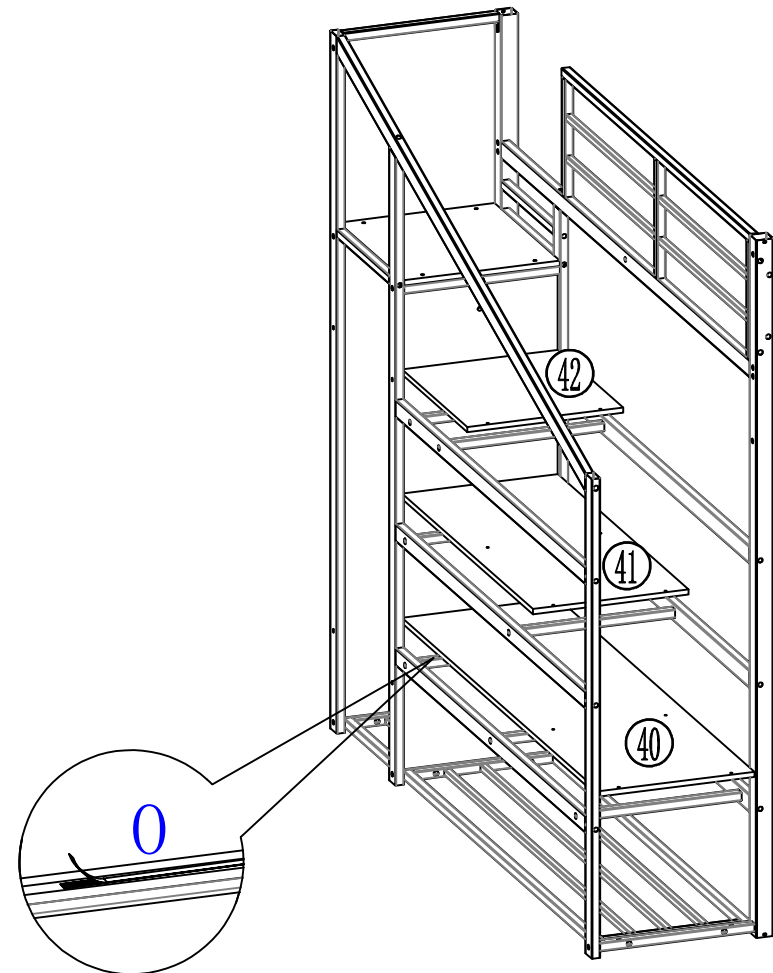



Please secure with double-sided tape O

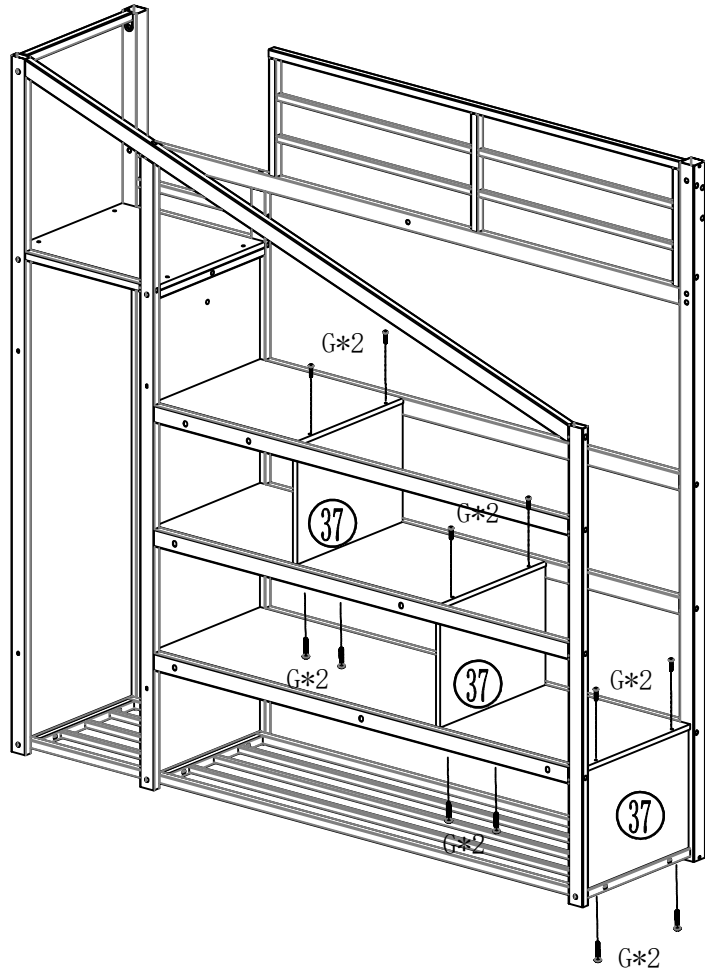

O

Step 9



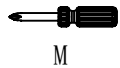

 G
4*25-12PCS

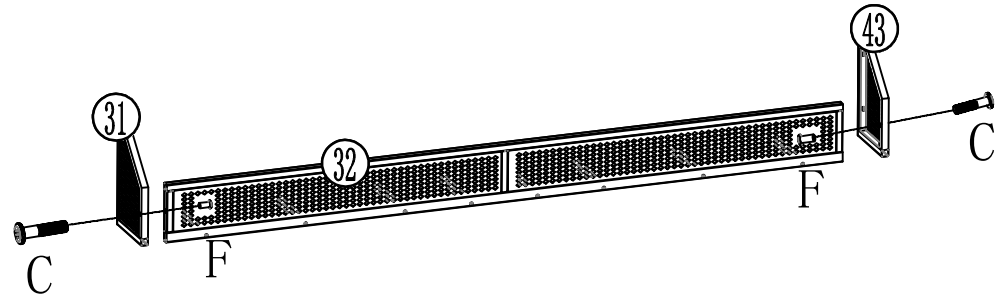

Step 10

Assemble and keep ready.



 F
4*15-2PCS

 C
8*35
2PCS



Step 11

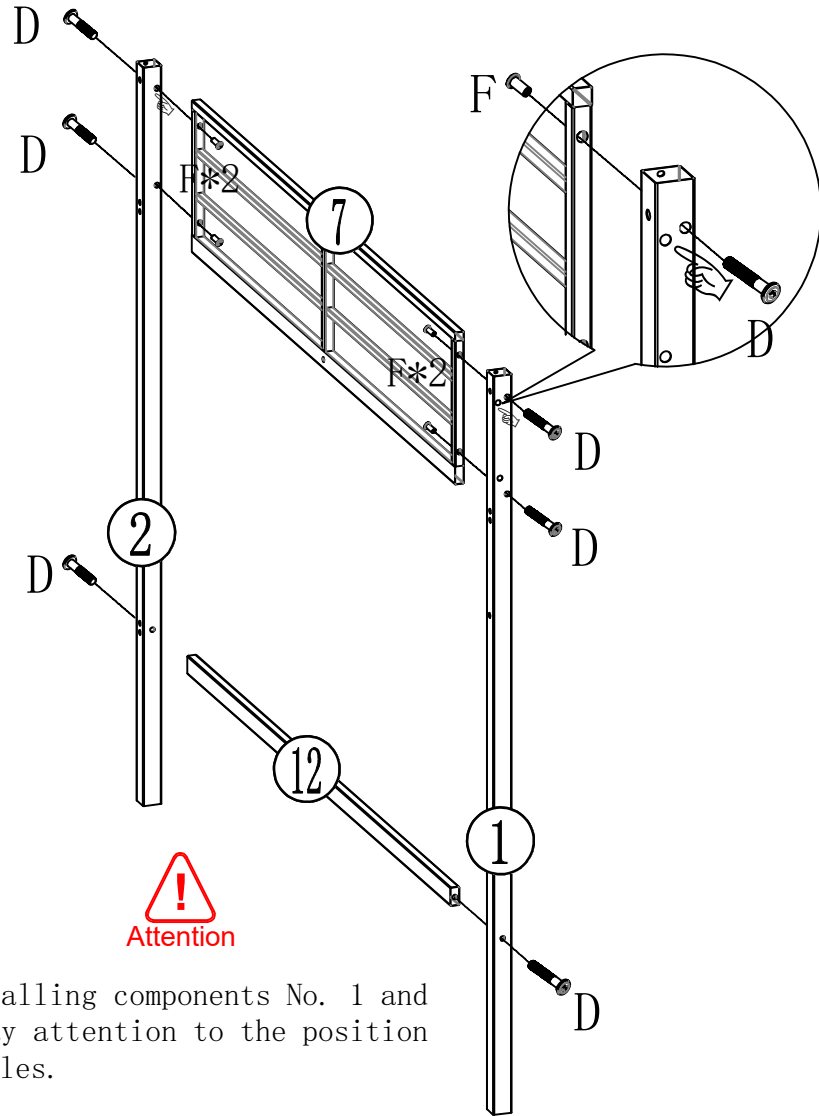

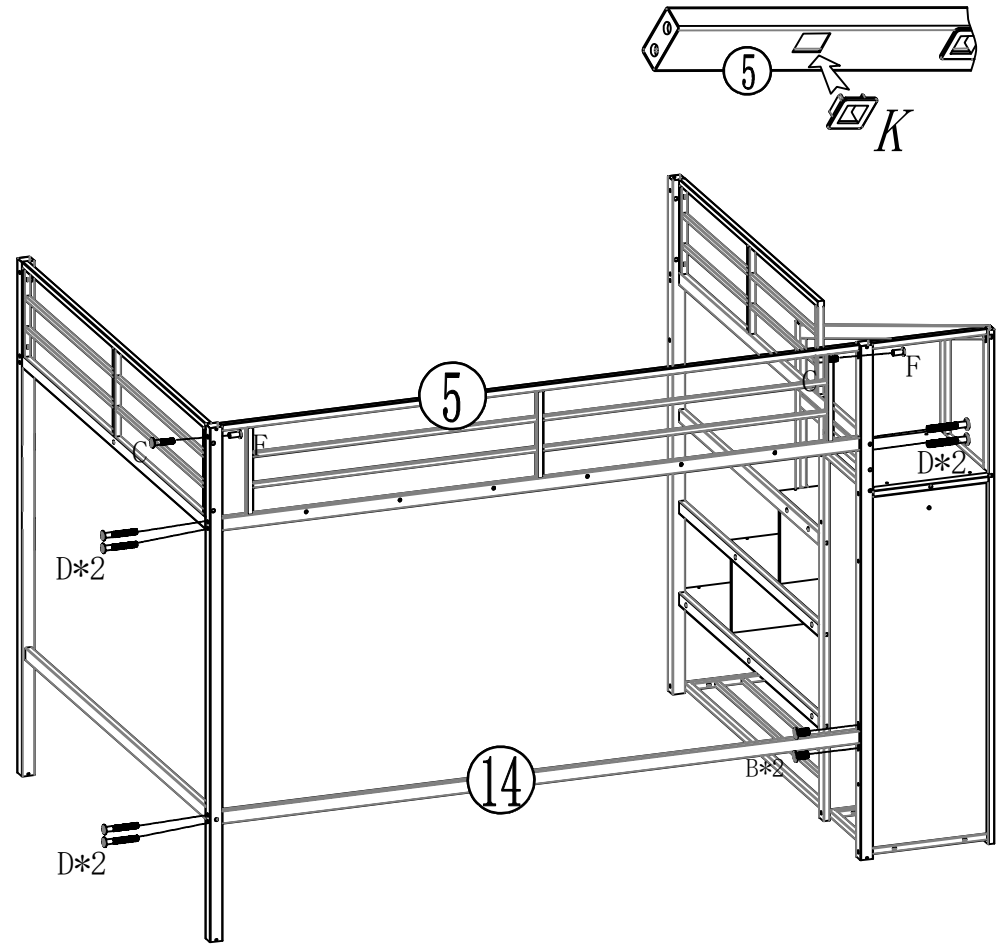

When installing components No. 1 and No. 2, pay attention to the position of the holes.

Step 12





F
4*15-4PCS



D
8*55-6PCS



L

D
8*55-6PCS



F
4*15-2PCS

B
8*15-2PCS

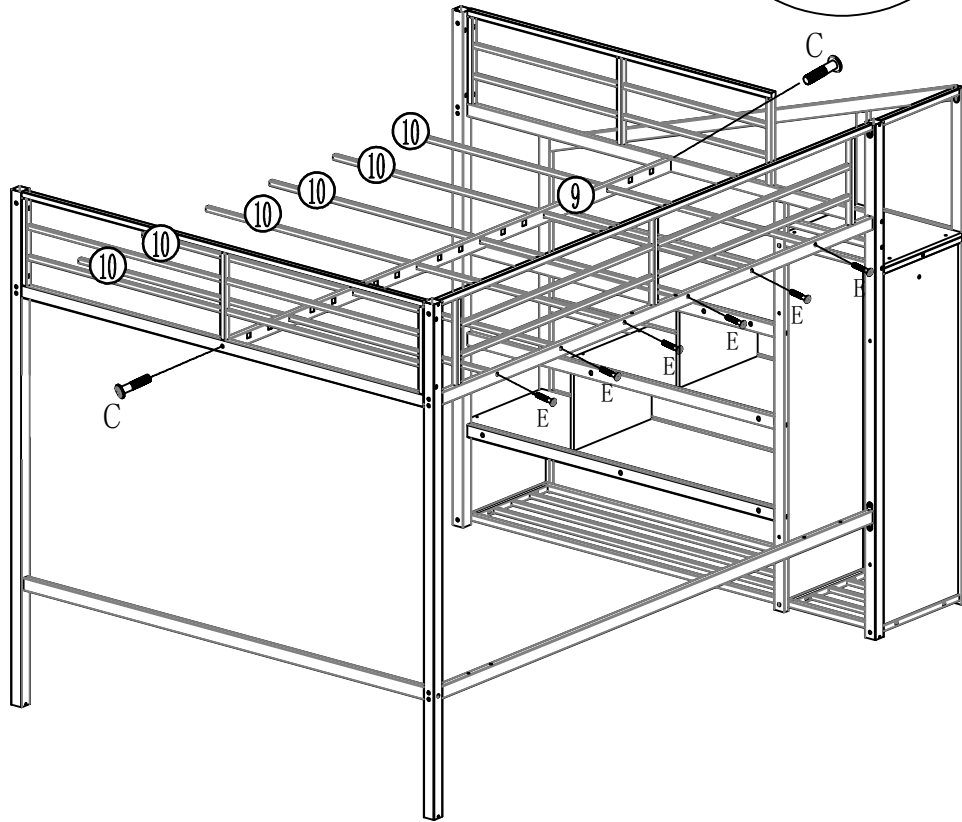
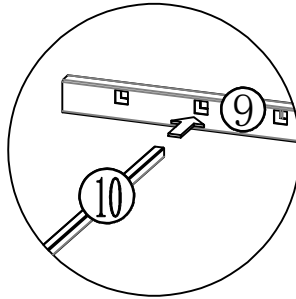
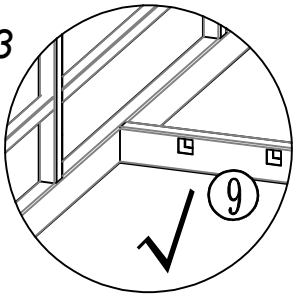

C
8*35
2PCS

L

Step 13

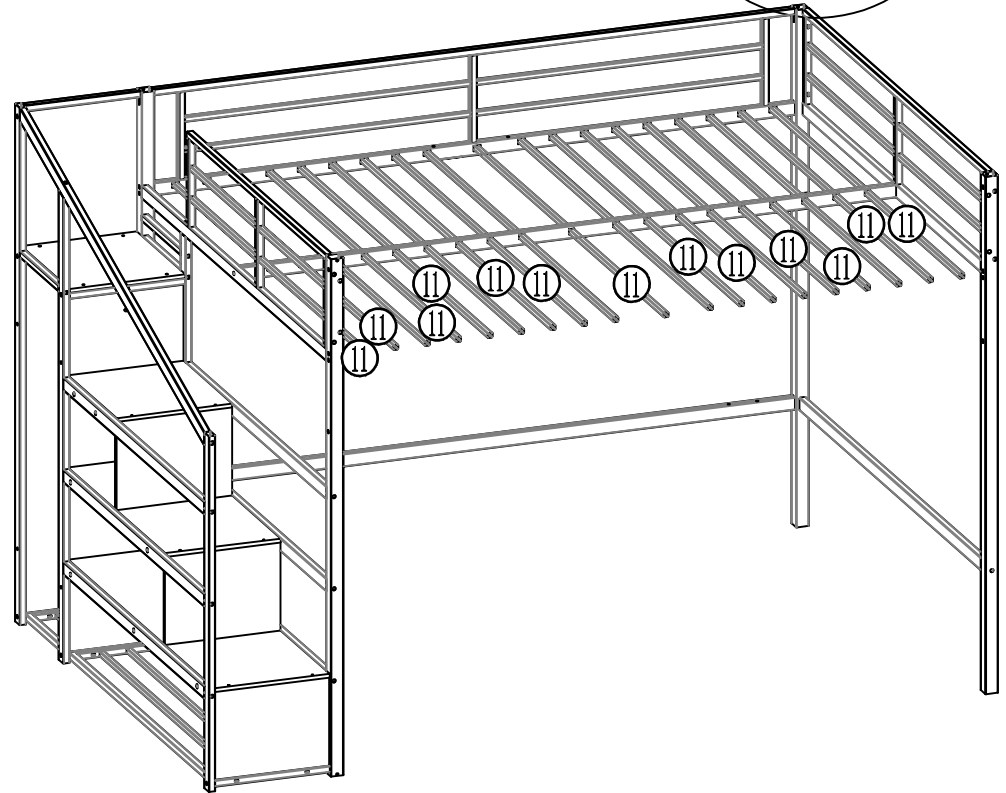
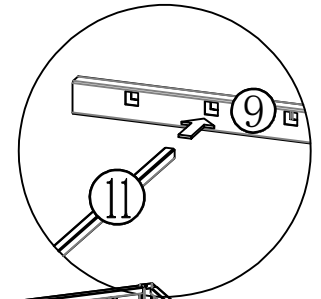

Step 14



C
8*35
2PCS

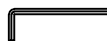

L



E
6*30-6PCS

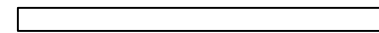

#11
13PCS

Step 15

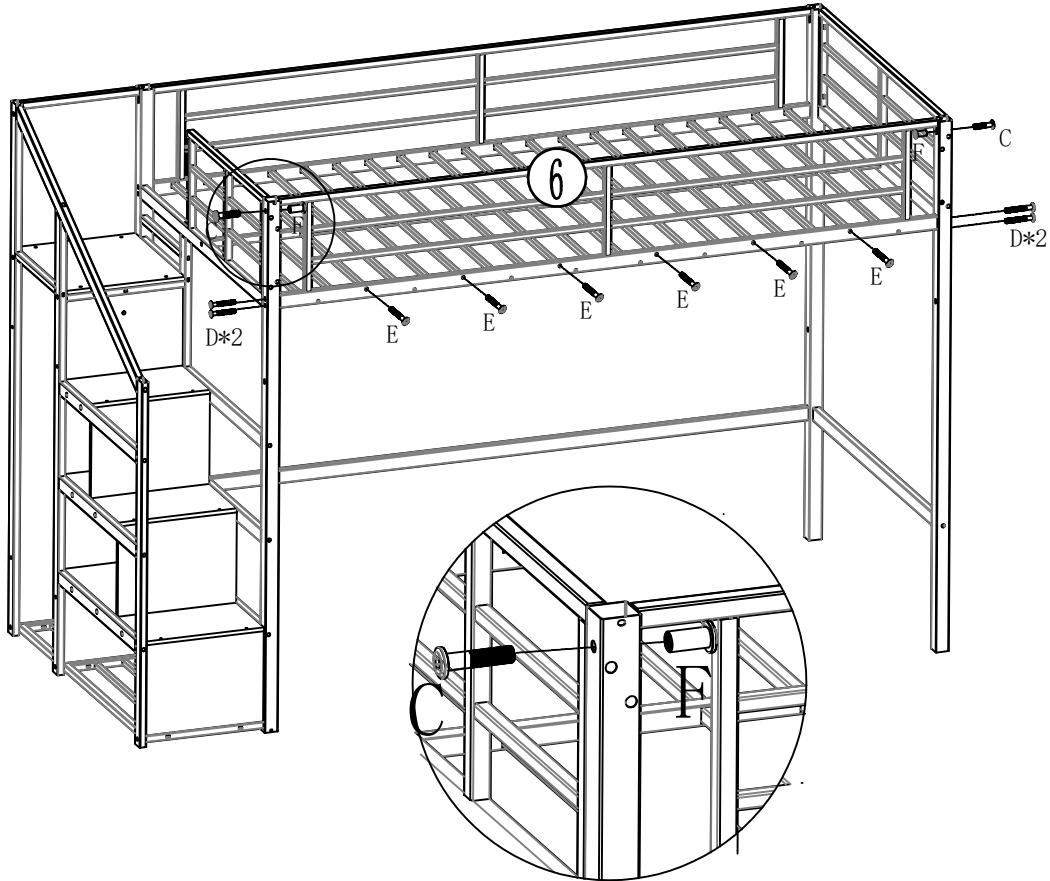
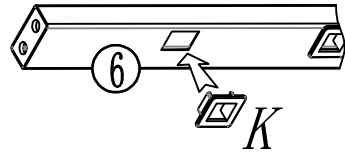

Step 16

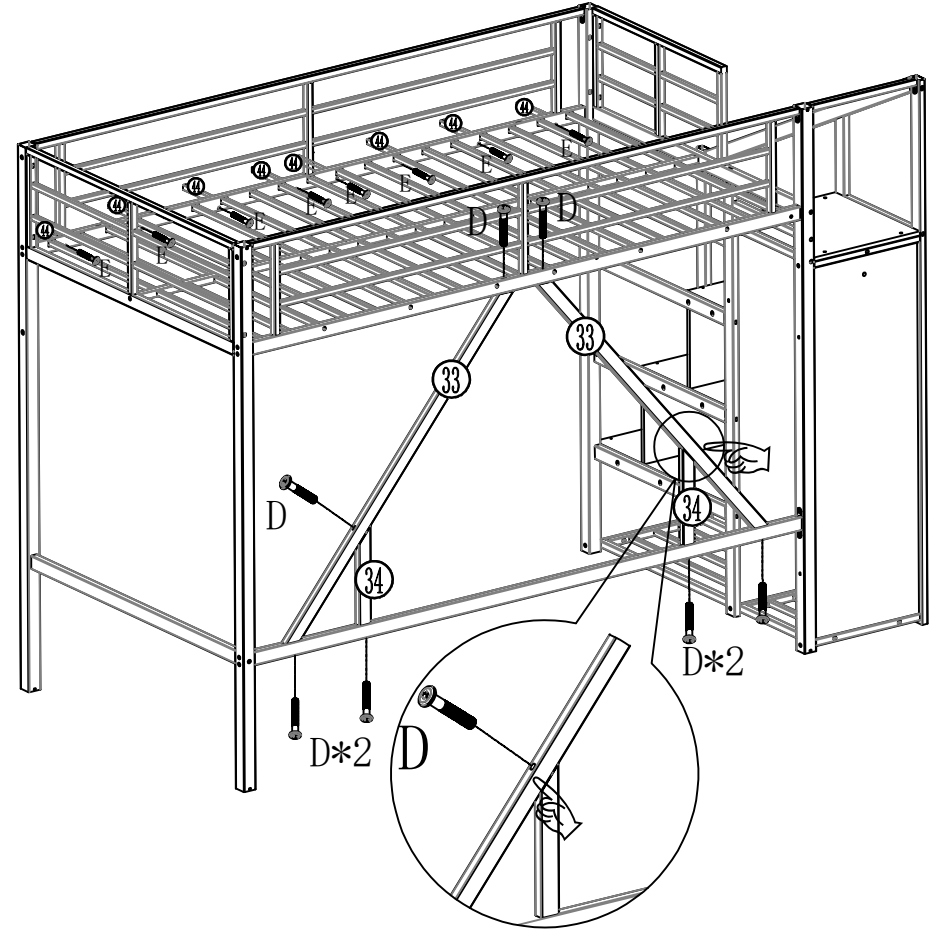

D
8*55-4PCS



L



E
6*30-6PCS



F
4*15-2PCS



C
8*35
2PCS



D
8*55-8PCS





E
6*30-8PCS

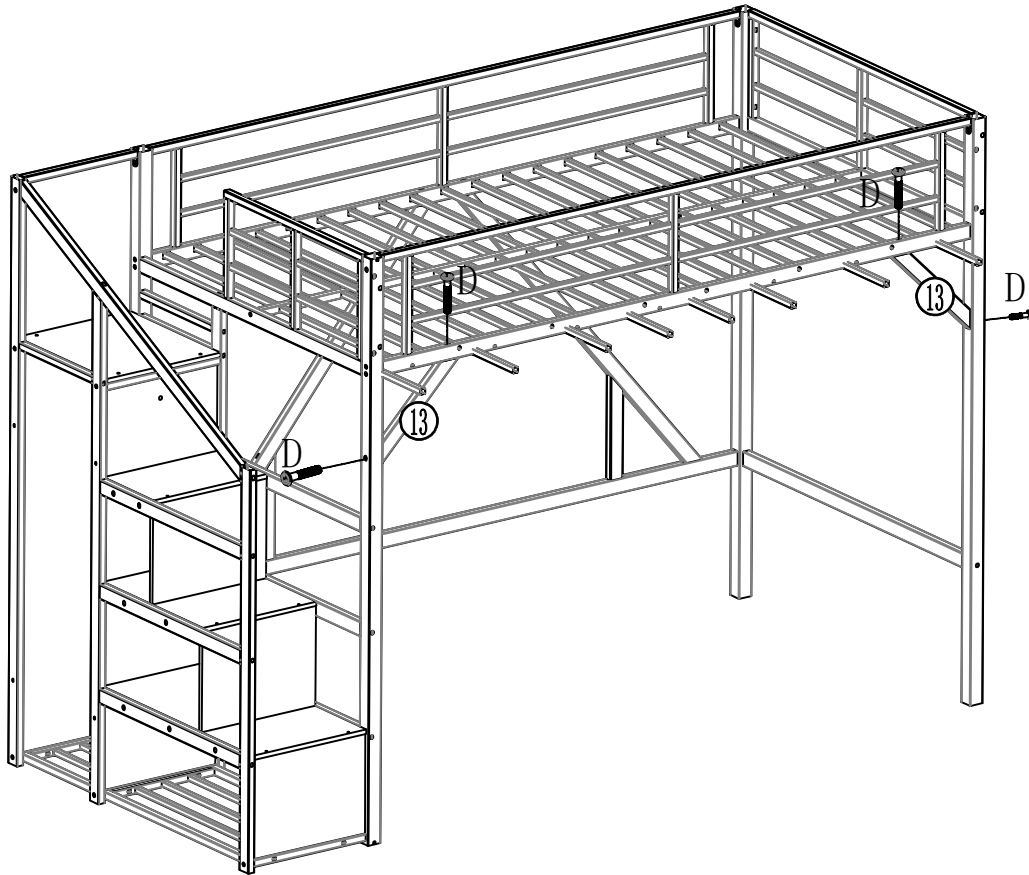

L

Step 17





D
8*55-4PCS

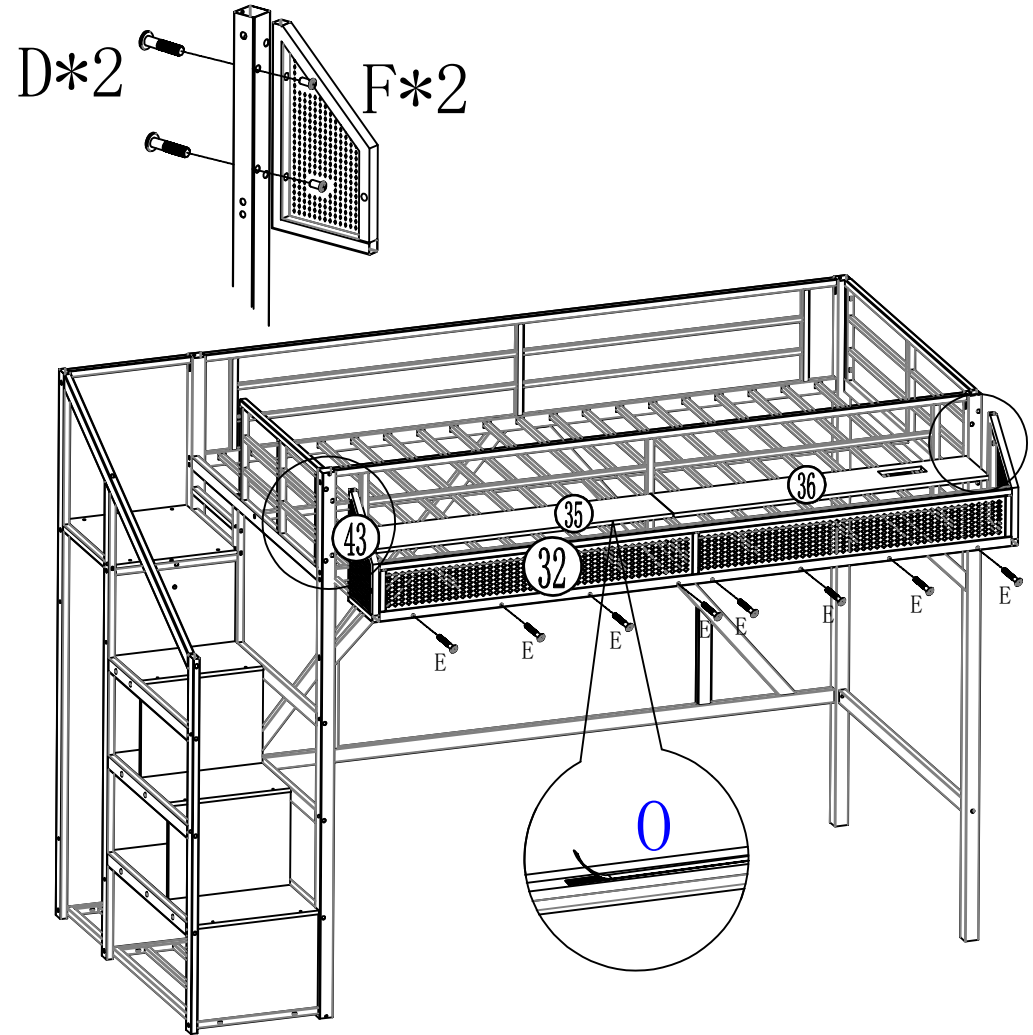

L

Step 18



D*2 F*2

D
8*55-4PCS



F
4*15-4PCS

E
6*30-8PCS



L

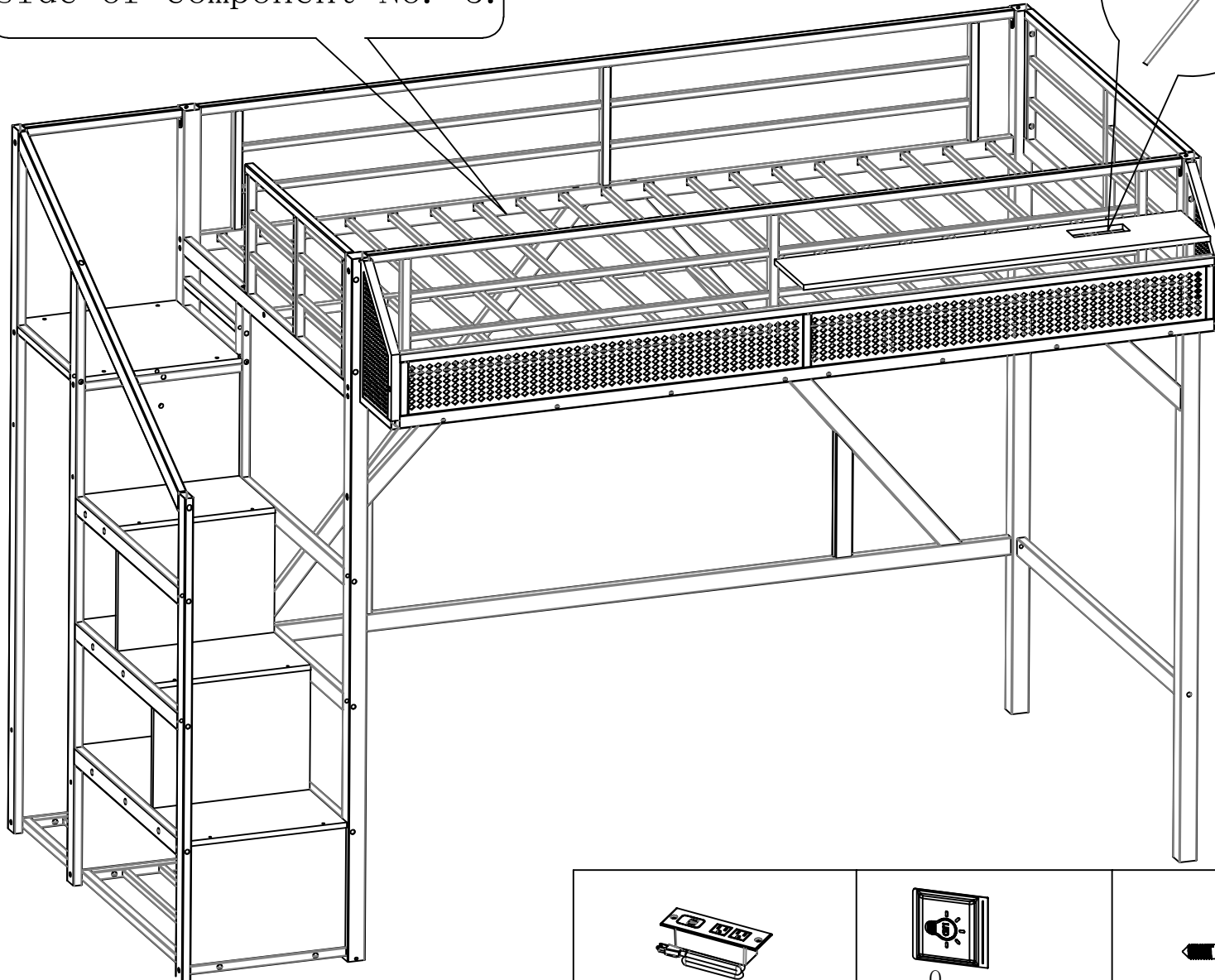
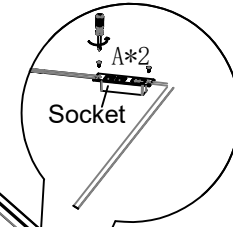

The light strip is attached to the inner side of component No. 5.

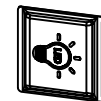

P
Socket-1pcs



Q
Light strips
1pcs



A 4*10-2PCS



M

Completed loft bed

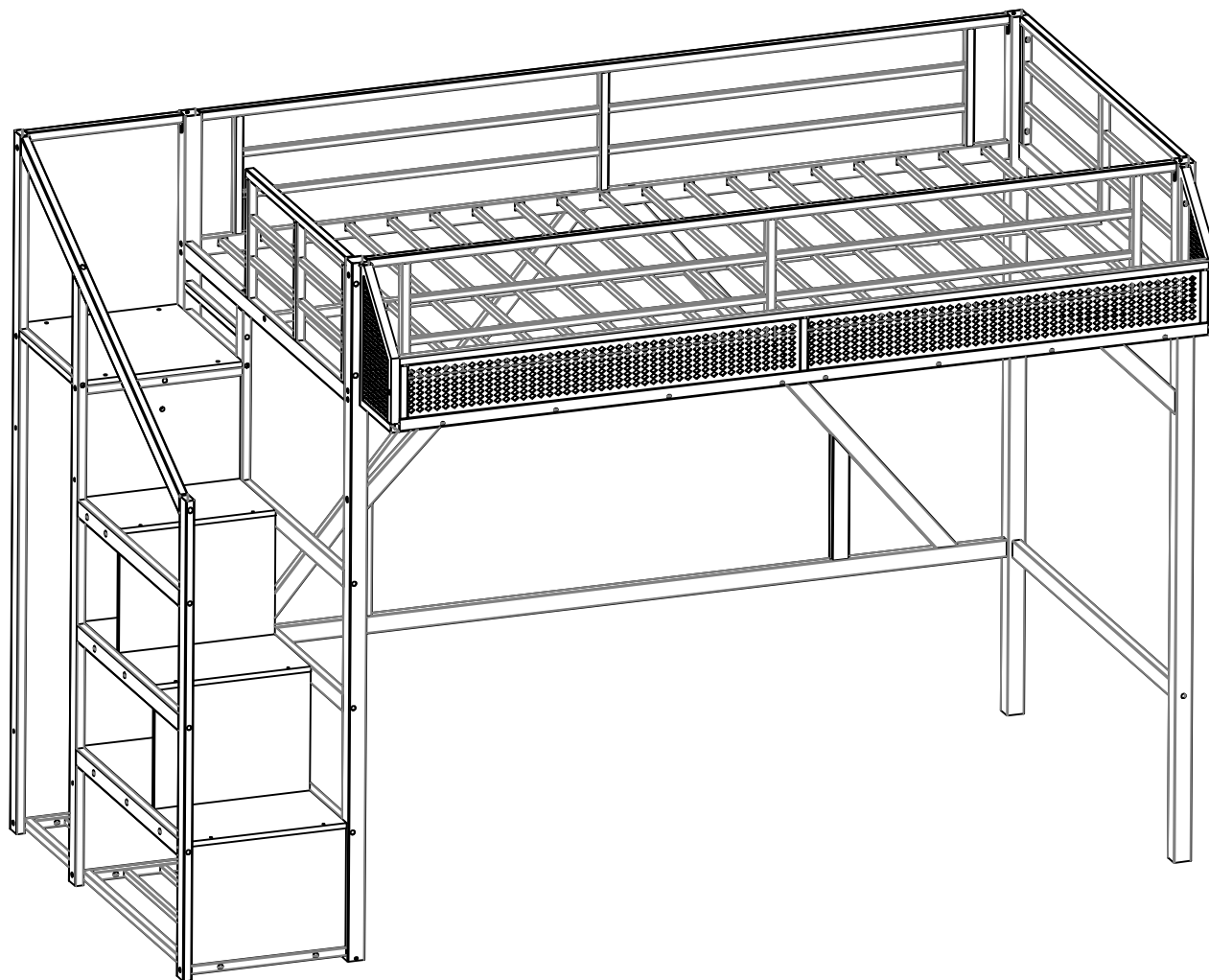

*Tips:
If you feel that the bed
is a little wobbly then
please use the parts "U"
and "T" for reinforcement*

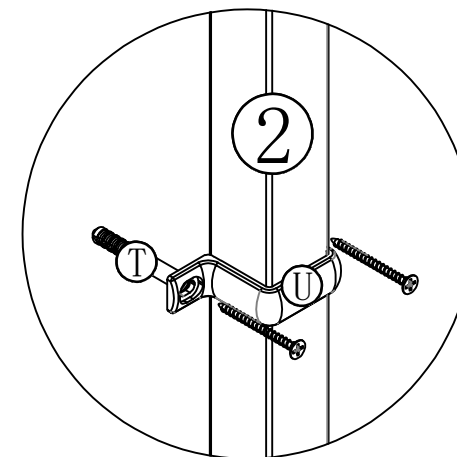

Attention

Please make sure all bolts are fastened before use, thank you.