

ARCHED DOOR BED WITH TWO DRAWERS

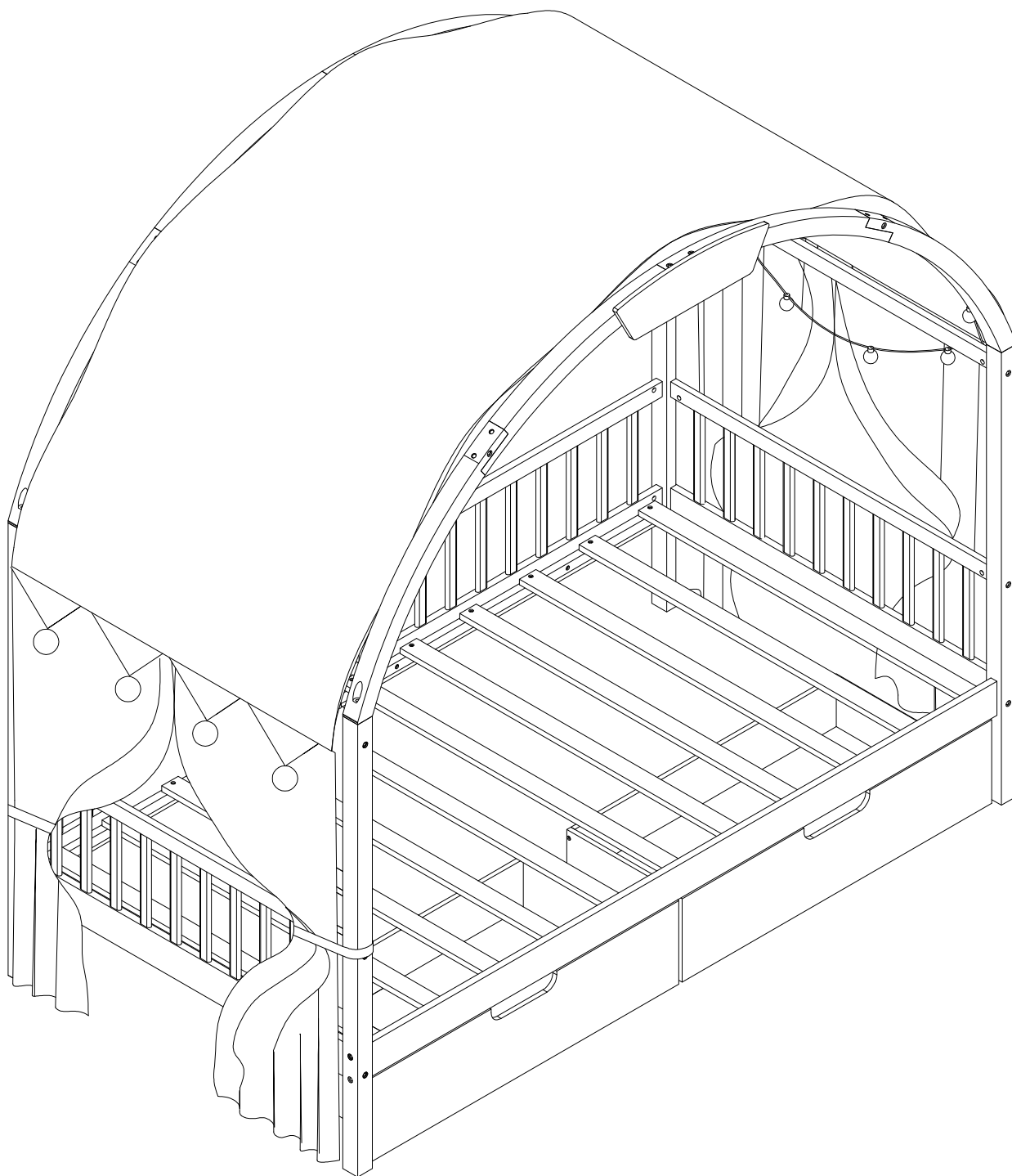

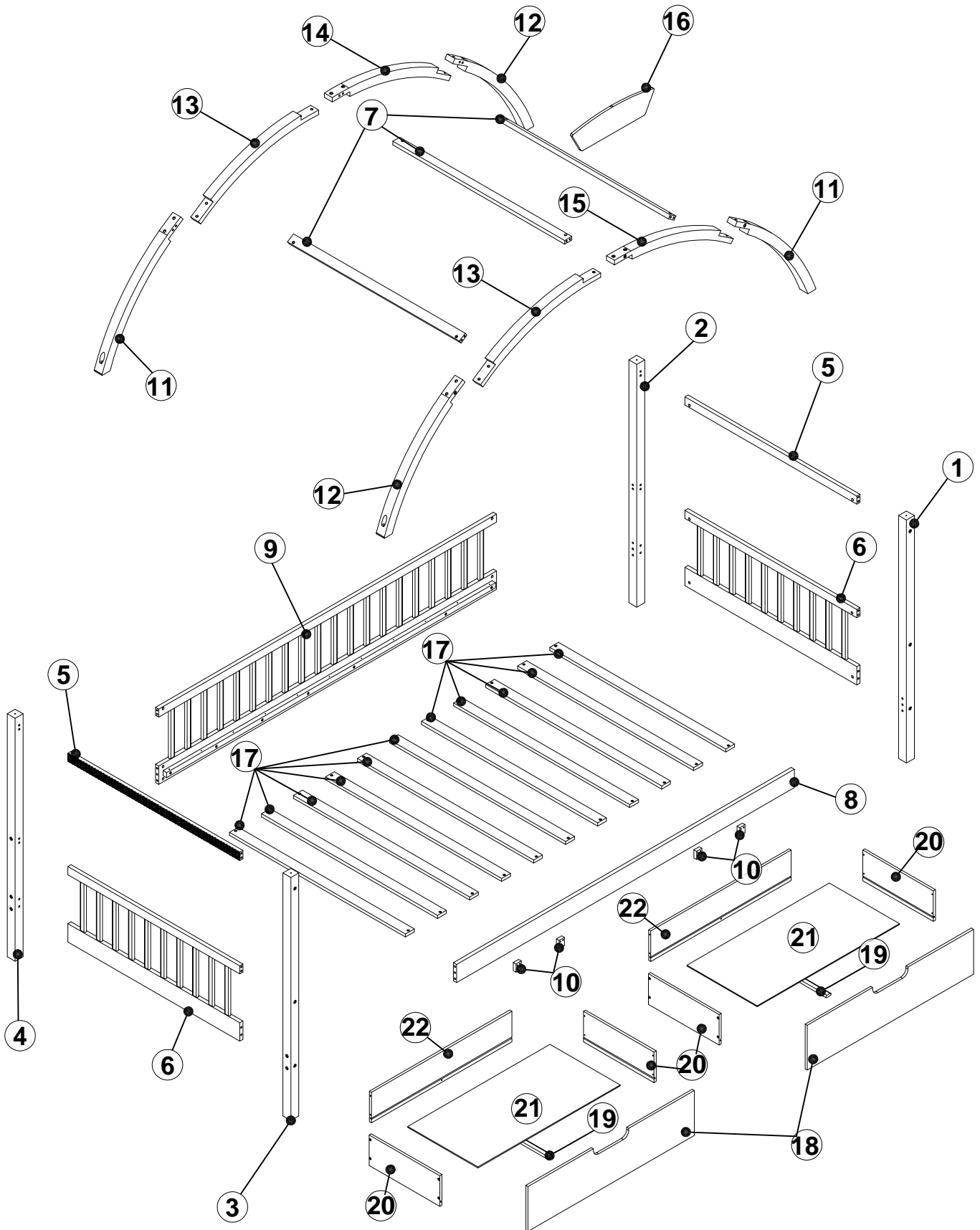







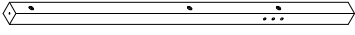

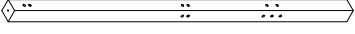

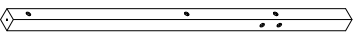
PRODUCT DETAILS

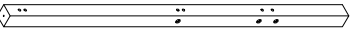
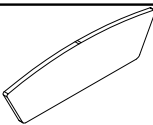
DÉTAILS DU PRODUIT

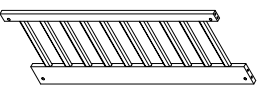
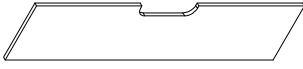
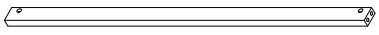
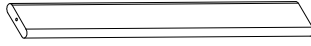

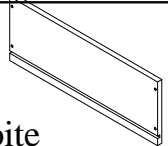
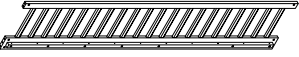
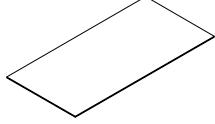
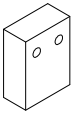
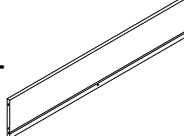



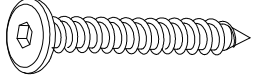
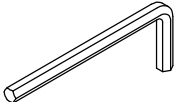

PARTS LIST LISTE DES PIÈCES

1	 Right front leg Jambe avant droite	1pc	13	 Curved top rail 3 Barre Supérieure incurvée 3	2pcs
2	 Right back leg Patte arrière droite	1pc	14	 Curved top rail 4 Barre Supérieure incurvée 4	1pc
3	 Left front leg Jambe avant gauche	1pc	15	 Curved top rail 5 Barre Supérieure incurvée 5	1pc
4	 Left back leg Jambe arrière gauche	1pc	16	 Decoative board Panneau décoratif	1pc
5	 Top side rail Barre à gauche	2pcs	17	 Bed slats Murs du lit	11pcs
6	 Bed side frame Cadre de côté de lit	2pcs	18	 Drawer face Façade de tiroir	2pcs
7	 Top rail Barre à gauche	3pcs	19	 Bottom support Support inférieur	2pcs
8	 Front bed rail Épaule devant et dos	1pc	20	 Drawer side Ferme le tiroir de droite	4pcs
9	 Back bed frame Cadre de dossier de lit	1pc	21	 Drawer board Fond de tiroir	2pcs
10	 Bugs blocking drawers Bugs bloquant les tiroirs	4pcs	22	 Behind the drawer Derrière le tiroir	2pcs
11	 Curved top rail 1 Barre Supérieure incurvée 1	2pcs			
12	 Curved top rail 2 Barre Supérieure incurvée 2	2pcs			

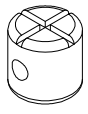
HARDWARE LIST

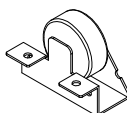
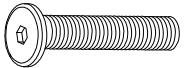
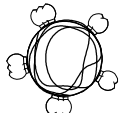
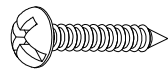

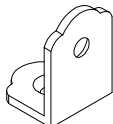
LISTE DU MATÉRIEL

A	M6*75mm		28pcs	H	M6*70mm		4pcs
B	L4		1pc	I	4*45mm		8pcs
C	Ø8*30mm		24pcs	K	Ø10*10mm		8pcs
D	4*25mm		42pcs	L			8pcs
E	M6*35mm		12pcs	N			1pc
F	M3.5*10mm		22pcs	M			1pc
G			3pcs				

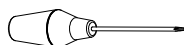
ASSEMBLY TOOLS REQUIRED (NOT INCLUDED)
 OUTILS D'ASSEMBLAGE REQUIS (NON INCLUS)



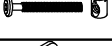

Step 1
Étape 1

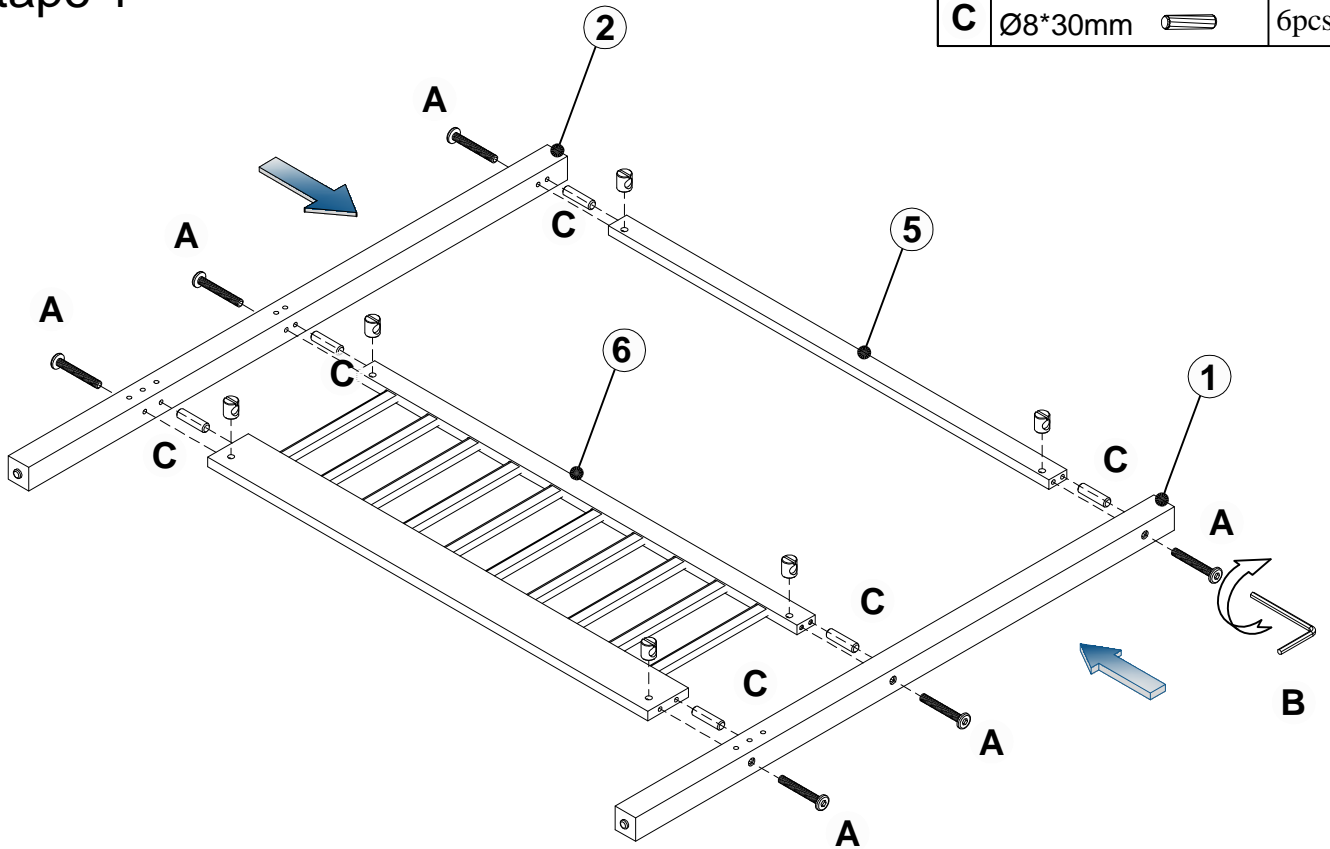
A	M6*75mm		6pcs
B	L4		1pc
C	Ø8*30mm		6pcs



Step 2
Étape 2

A	M6*75mm		6pcs
B	L4		1pc
C	Ø8*30mm		6pcs

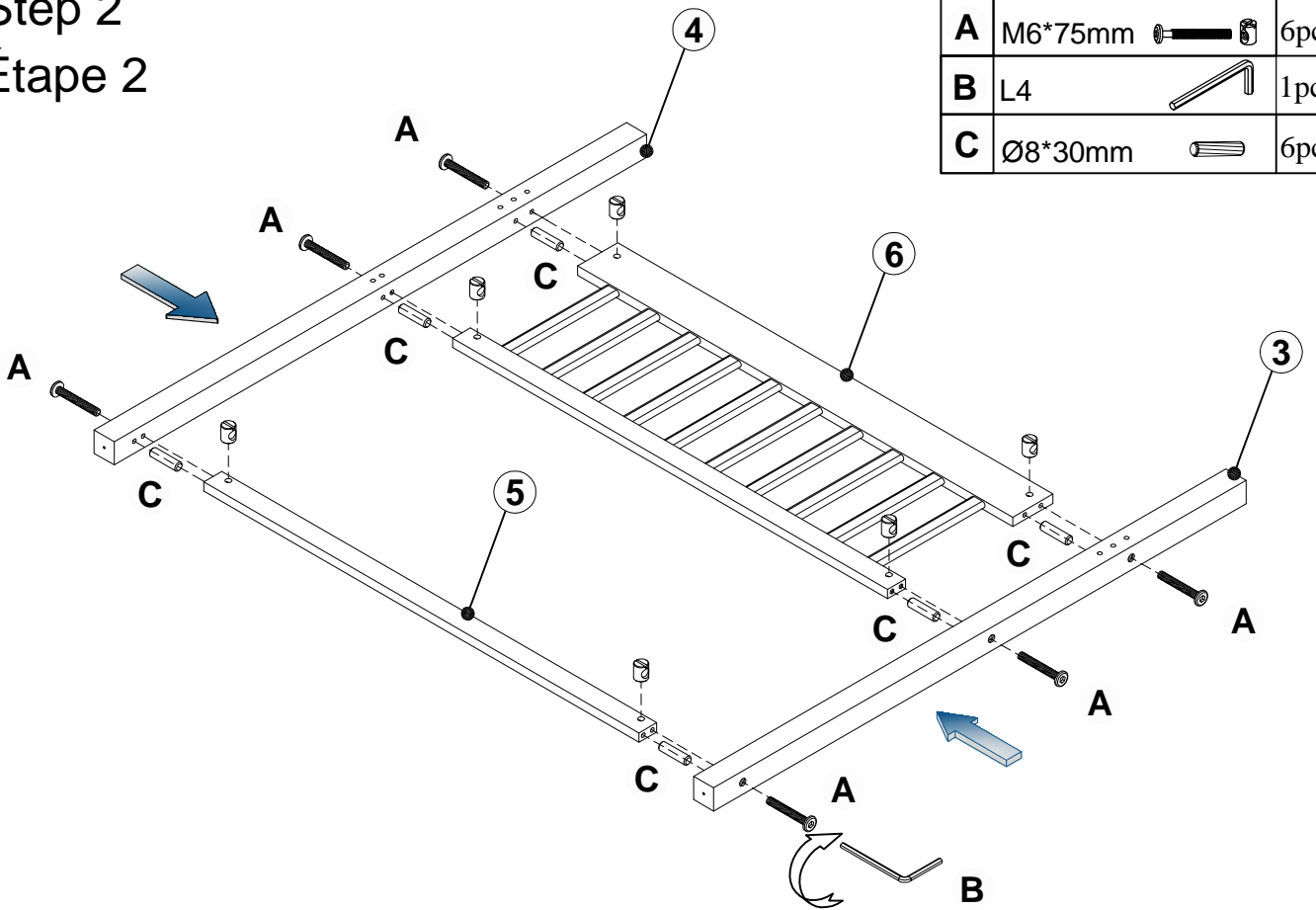

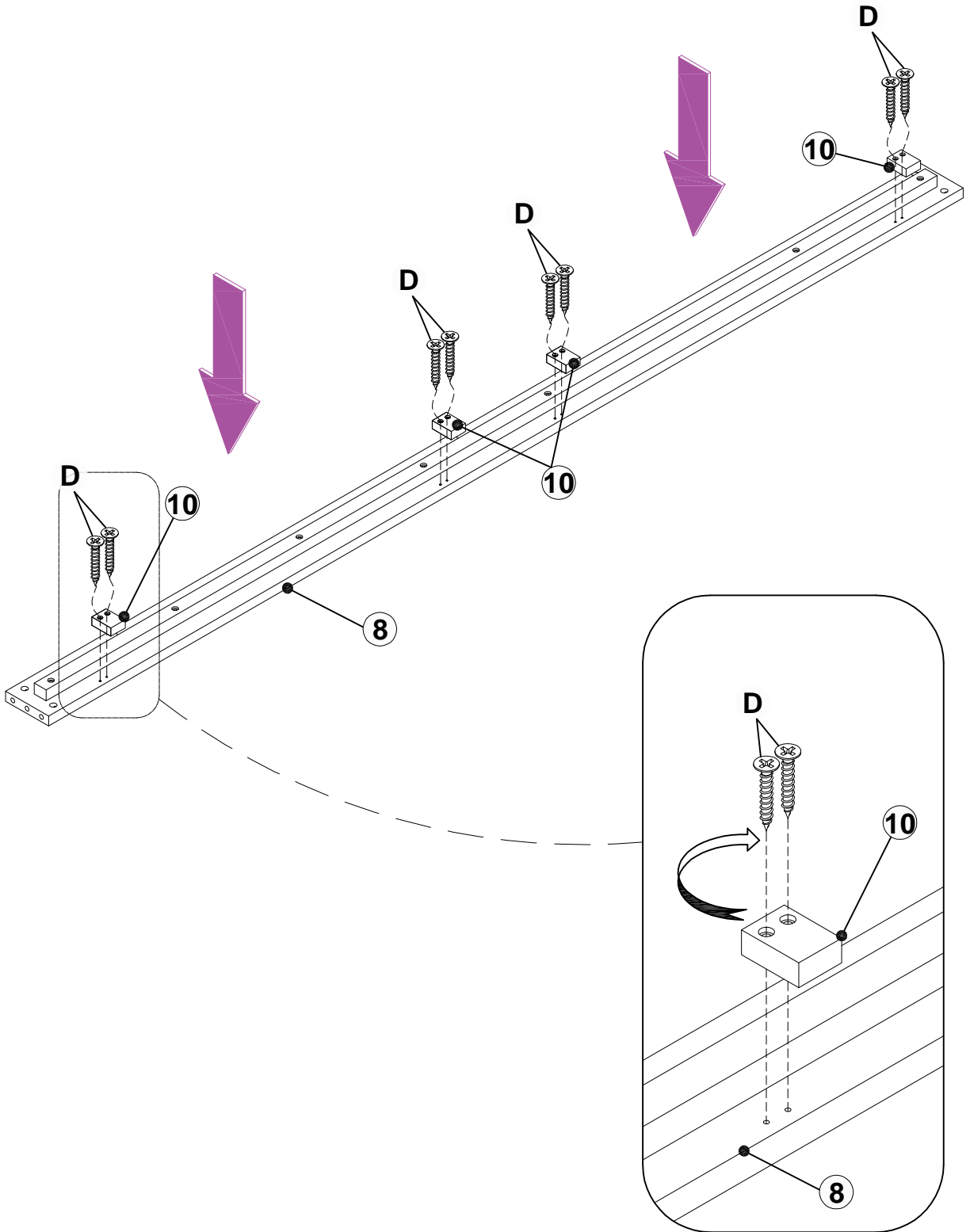

Step 3
Étape 3

D 4*25mm  8pcs



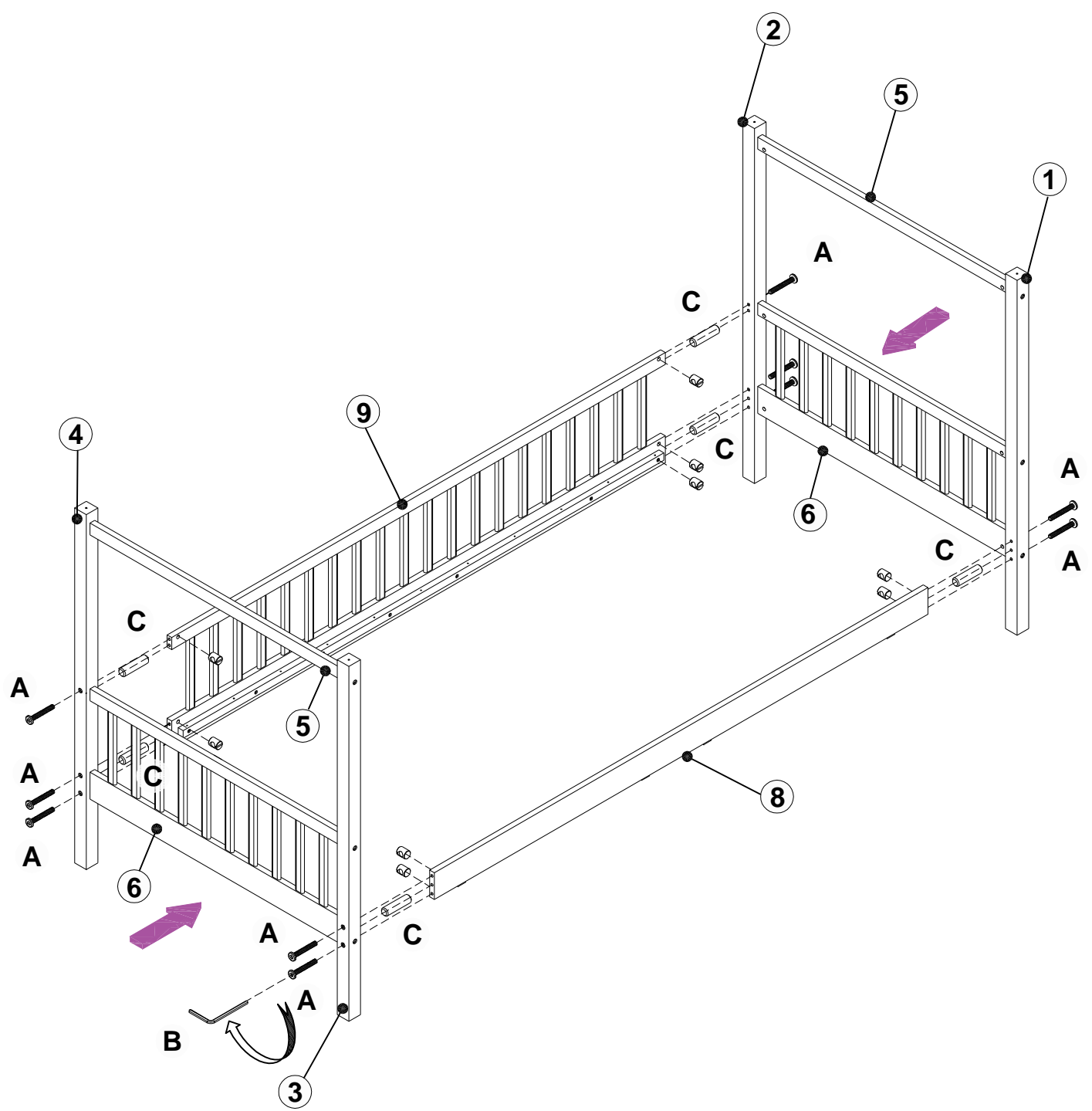

Step 4
Étape 4

A	M6*75mm		10pcs
B	L4		1pc
C	Ø8*30mm		6pcs



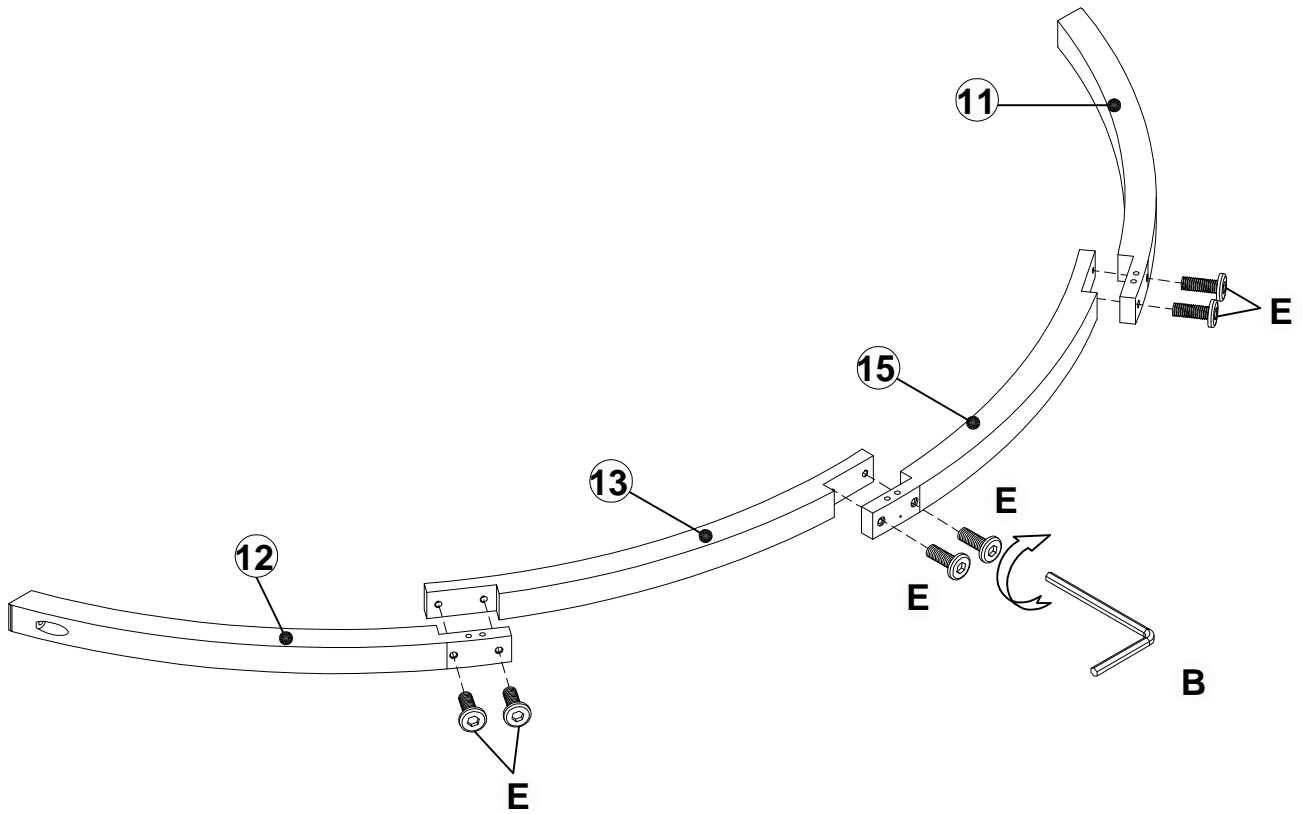

Step 5
Étape 5

B	L4		1pc
E	M6*35mm		6pcs



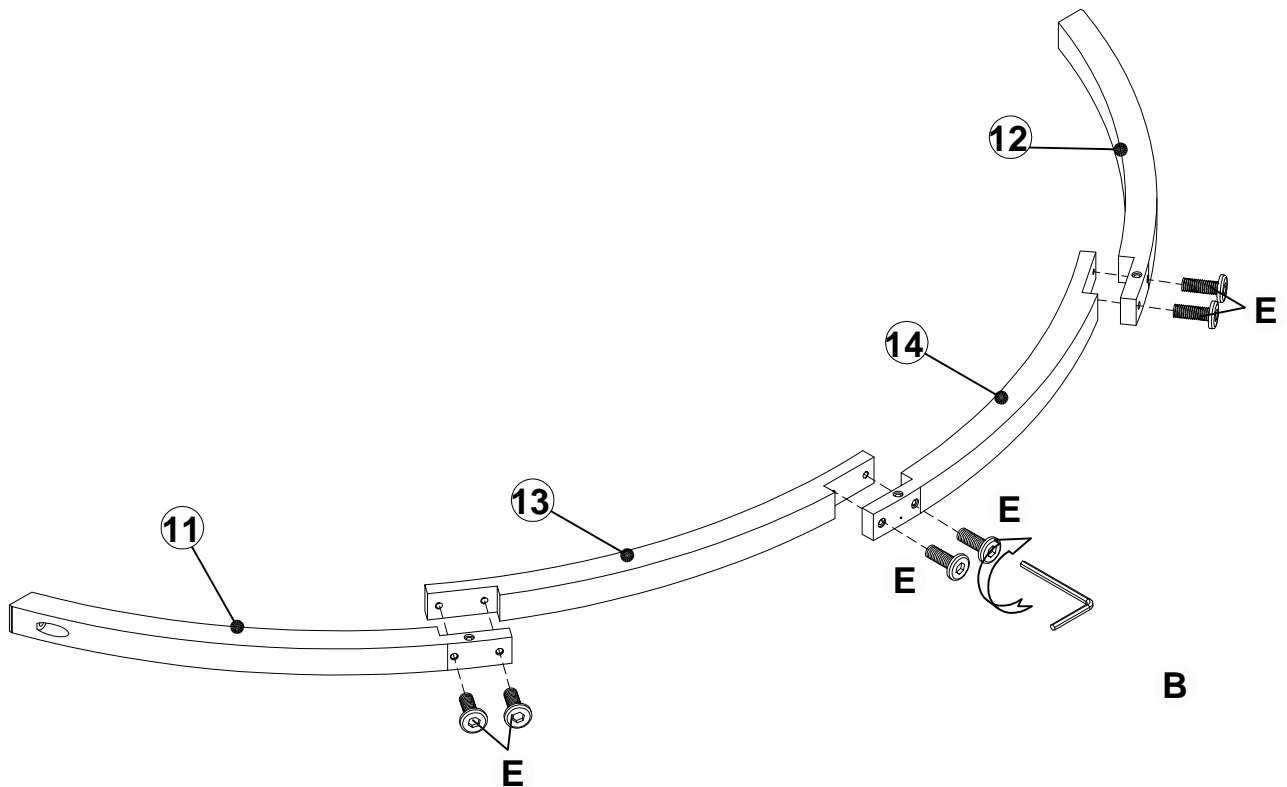

Step 6
Étape 6

B	L4		1pc
E	M6*35mm		6pcs



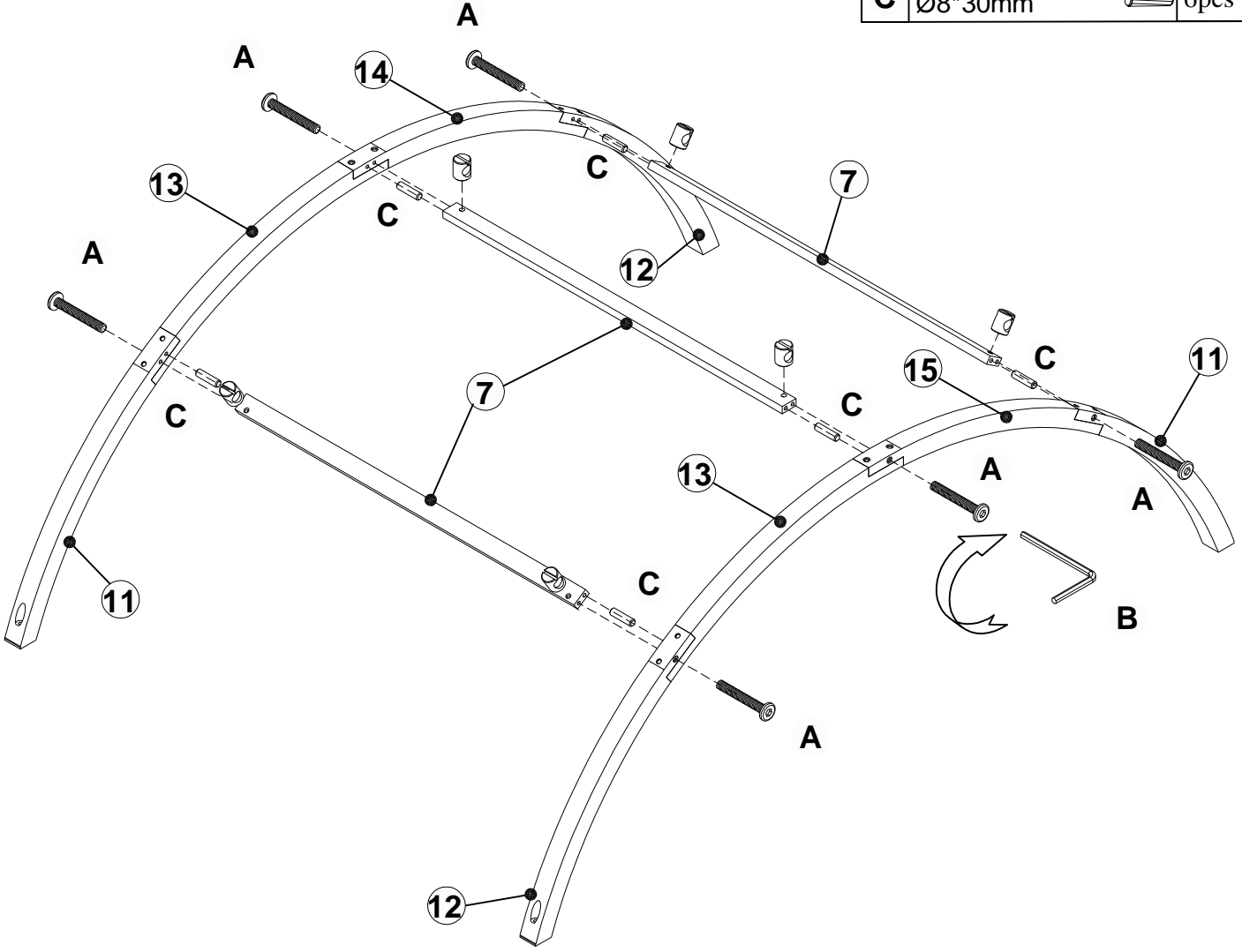

Step 7
Étape 7

A	M6*75mm		6pcs
B	L4		1pc
C	Ø8*30mm		6pcs



Step 8
Étape 8

F	M3.5*10mm		3pcs
G			3pcs

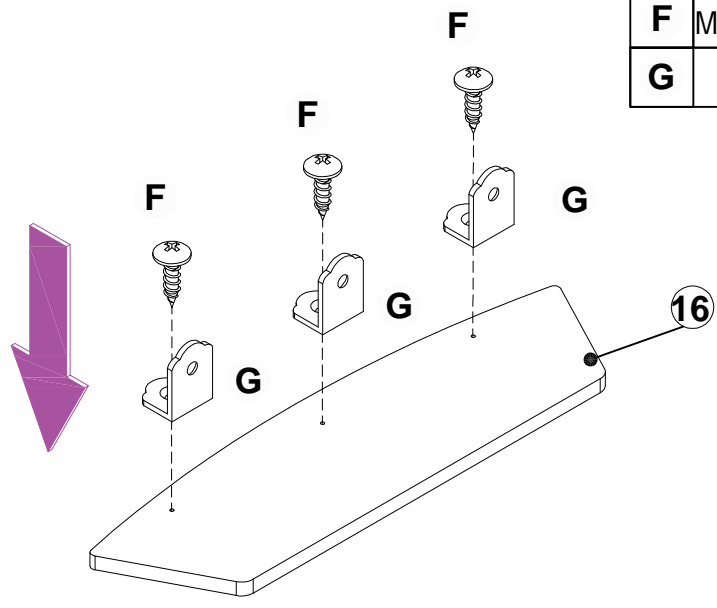

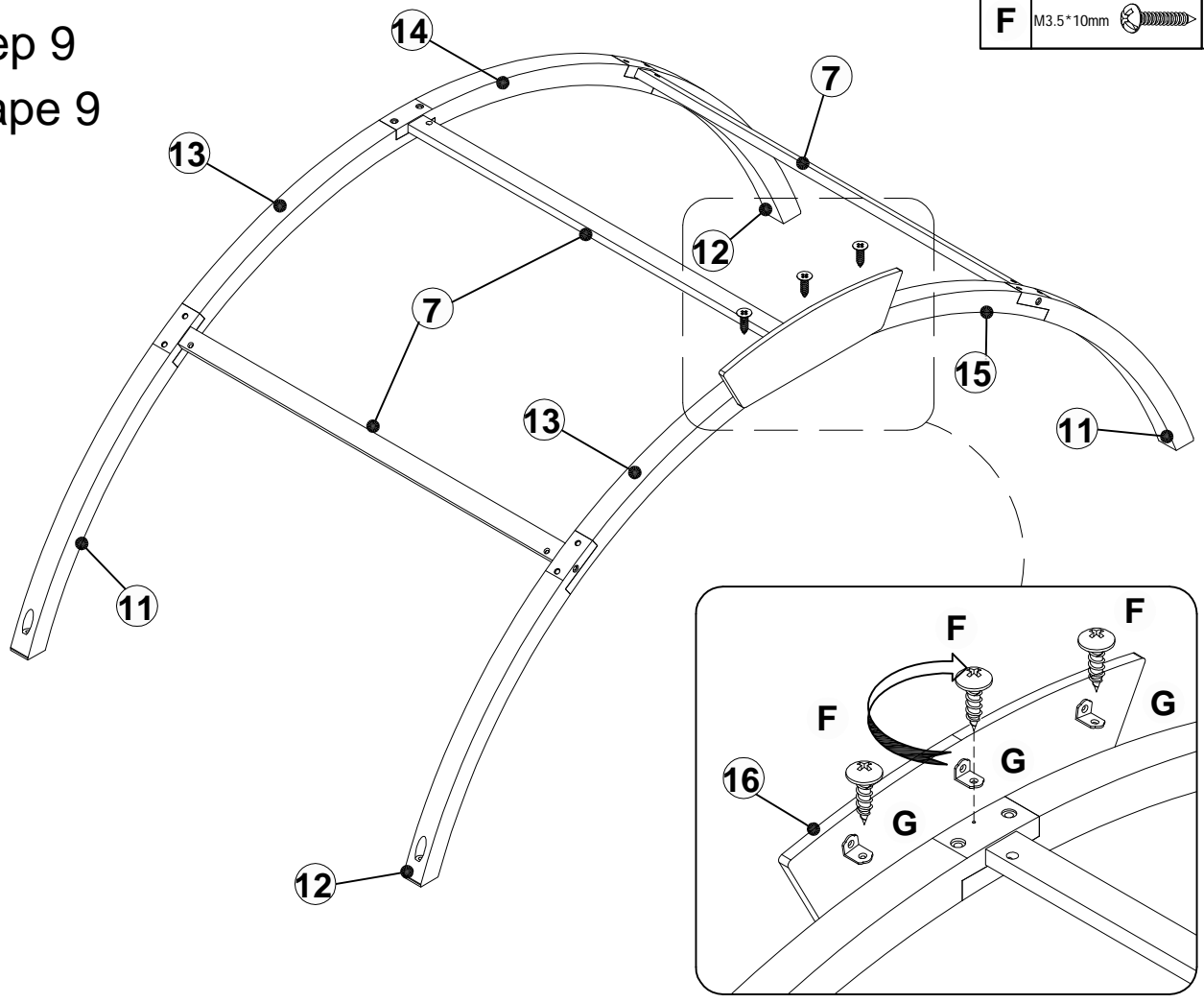

Step 9
Étape 9

F	M3.5*10mm		3pcs
----------	-----------	---	------

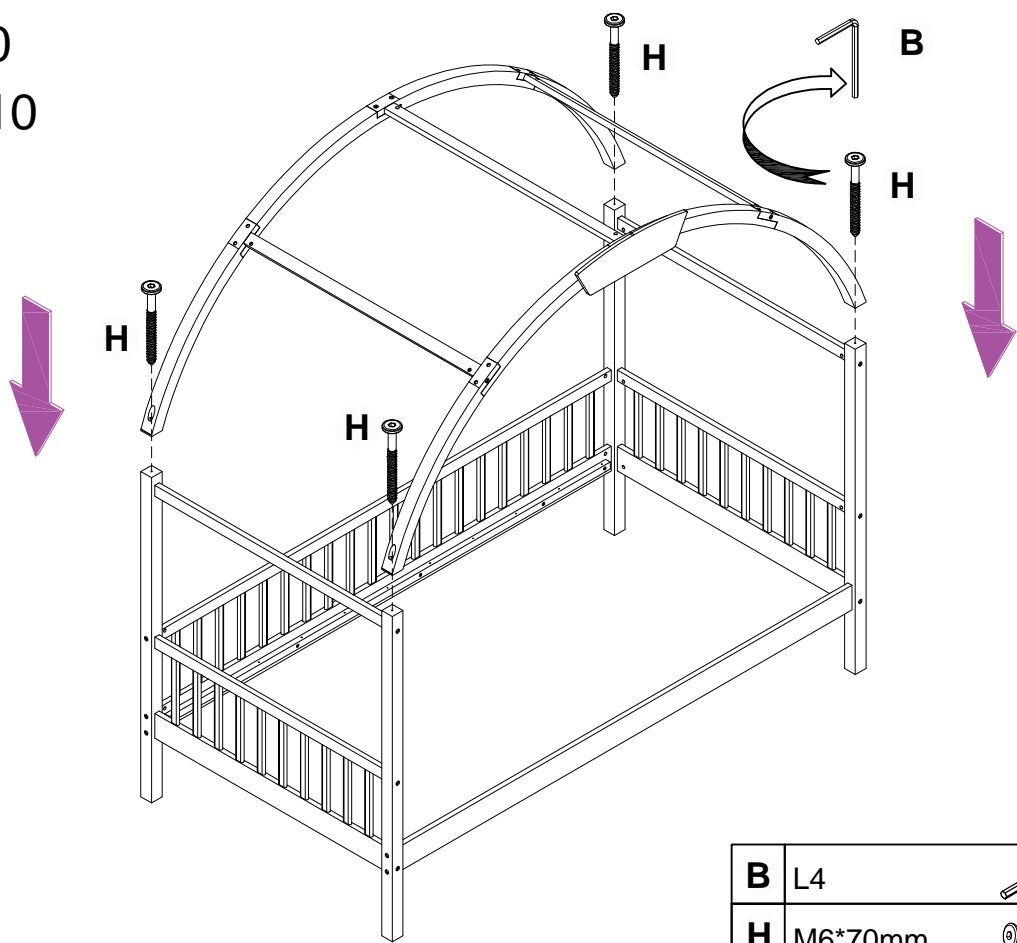

Step 10
Étape 10



B	L4		1pc
H	M6*70mm		4pcs

Step 11
Étape 11

D 4*25mm  22pcs

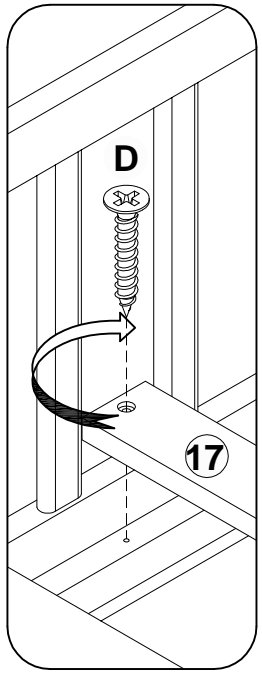
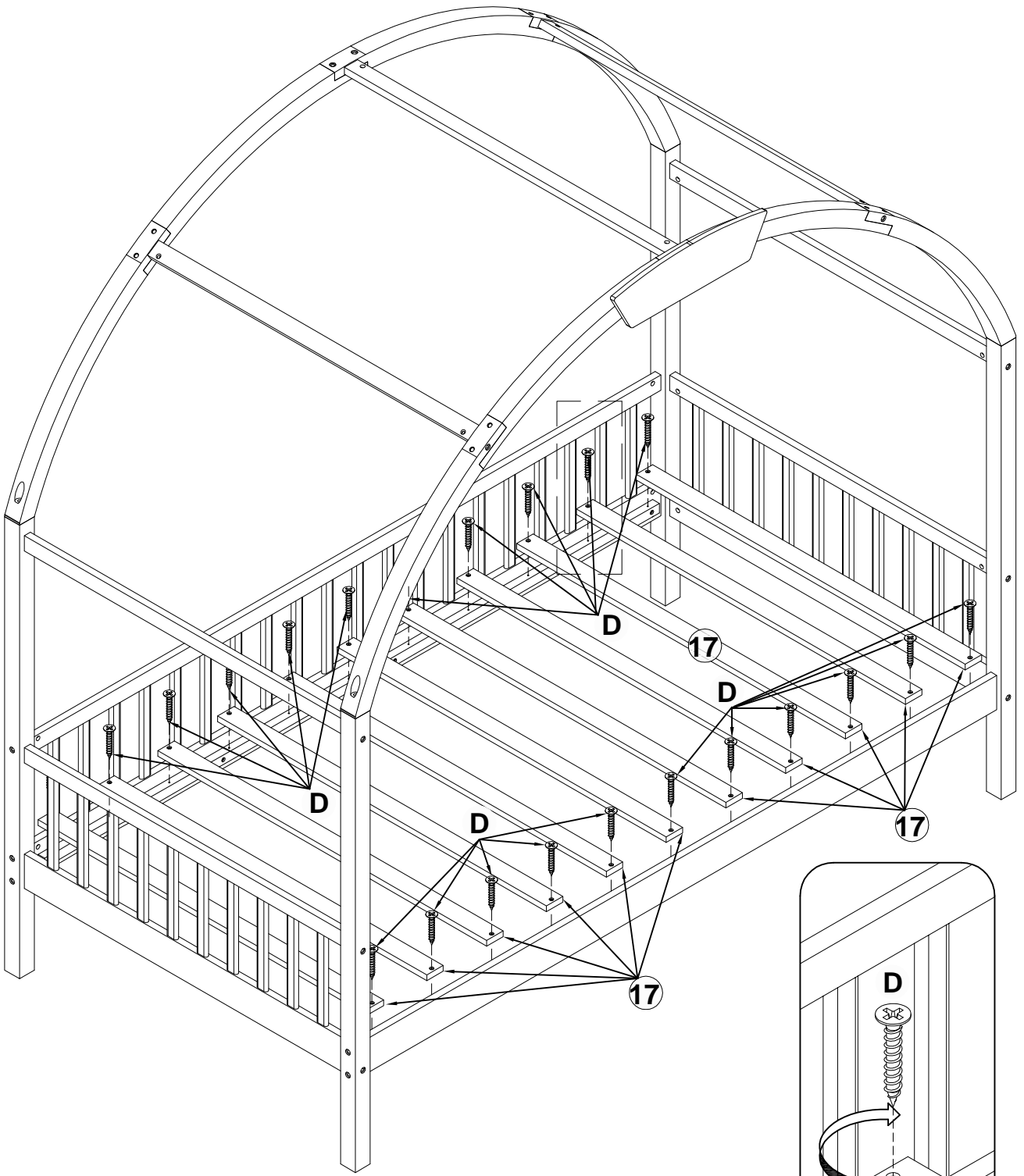

Step 12
Étape 12

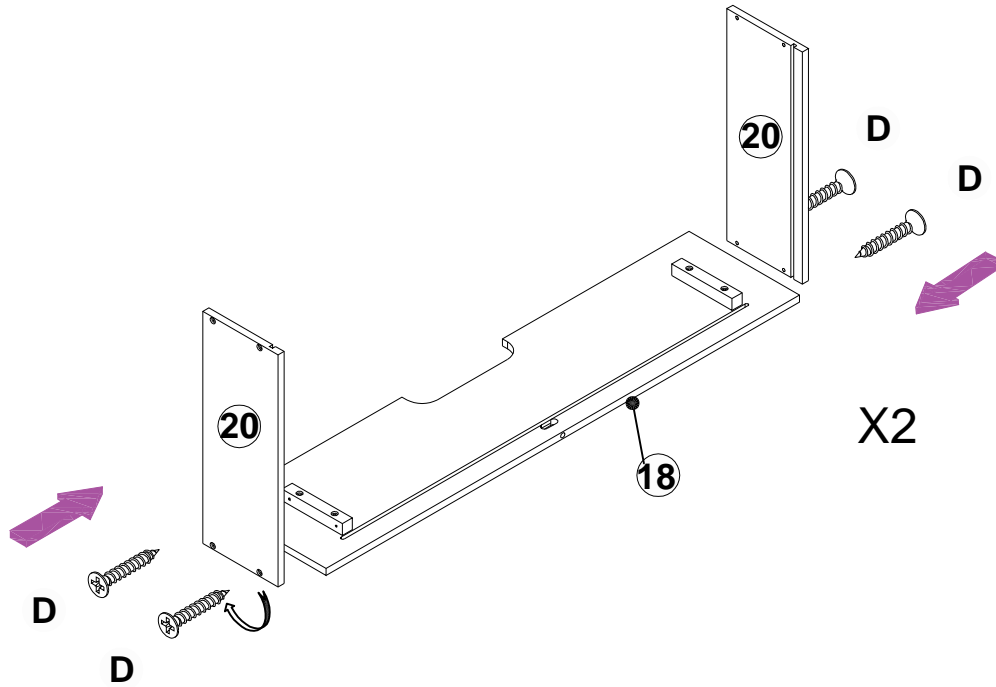

D 4*25mm  8pcs

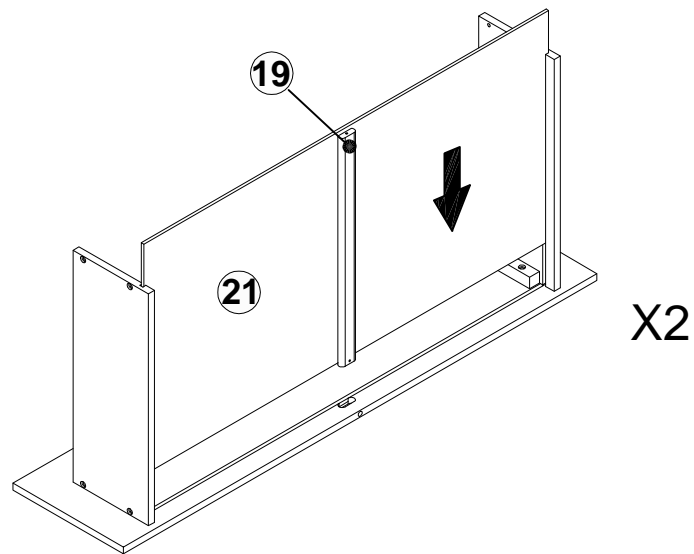

Step 13
Étape 13



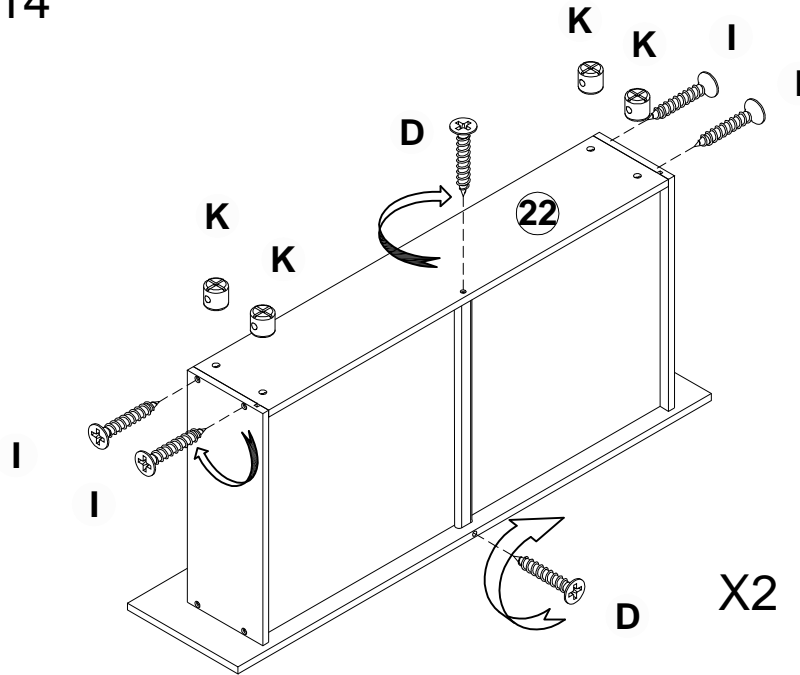

Step 14
Étape 14

D	4*25mm		4pcs
I	4*45mm		8pcs
K	Ø10*10mm		8pcs



Step 15
Étape 15

F	3.5*10mm		16pcs
L			8pcs

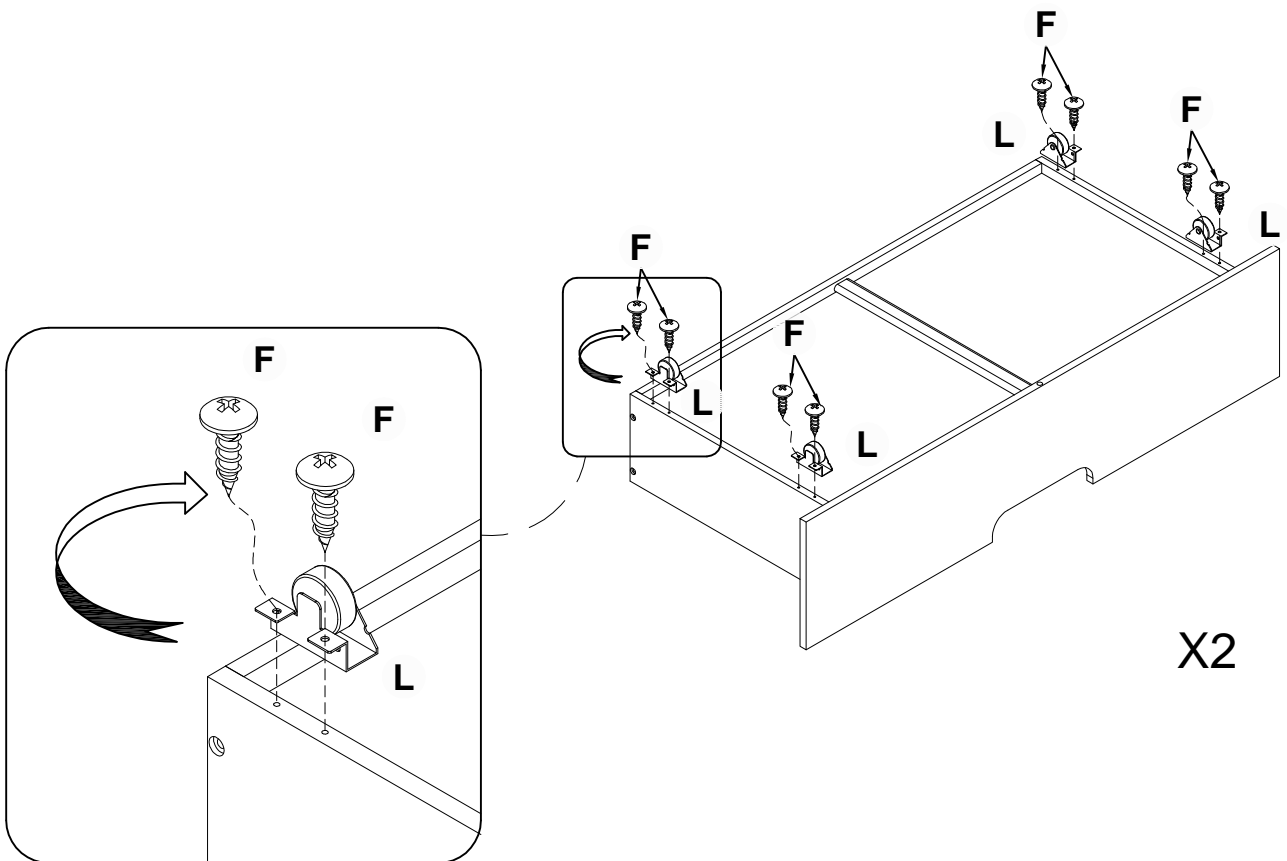

Step 16
Étape 16

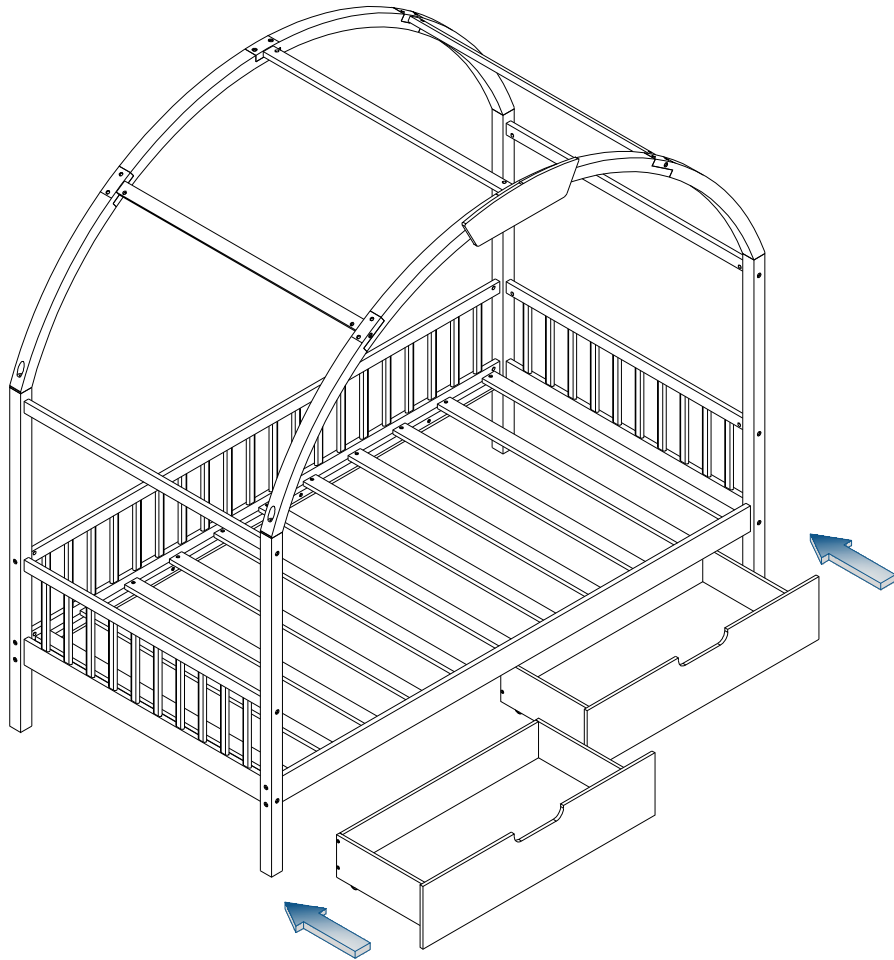

Step 17
Étape 17

N		16pcs
----------	---	-------

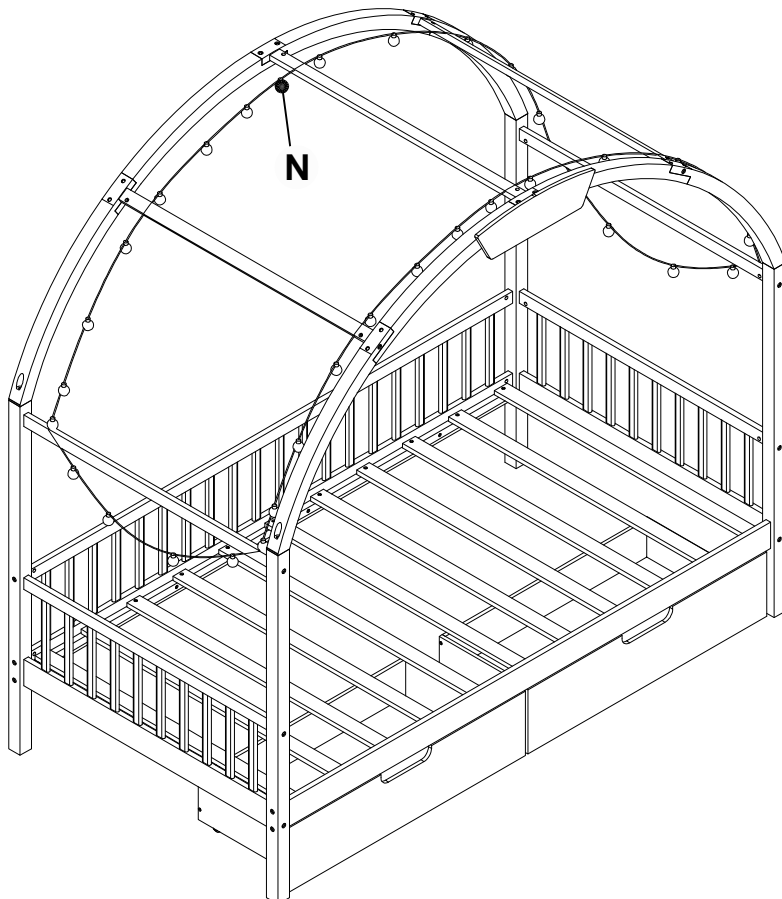

Step 18
Étape 18

M  1pc

