

Patio Door Installation Guide

For 3-Panel Set (Mid Rail) (3 Folding Panel)



Letter From the Manufacturer

Thanks for choosing the Bifold Patio Door from Ark Design. We hope you have a smooth installation after reading this manual.

To ensure an exact match for every bifold patio door, we **pre-assemble each door** in our factory, carefully adjust each one, and pre-drill holes for the hinges to ensure it's square and level so that all doors operate smoothly. Then the door is carefully disassembled, well packed, and delivered to your home in the safest and most cost-effective way.

Kind reminder for the installation:

- At least two people are needed for the operation. The door is very heavy and should be handled with extra care.
- Strictly follow the steps and always ensure it's level and plumb when required. This will provide the best user experience.
- The Installation Guide is for **Left Opening**. If you purchase **Right Opening**, start from the other direction from Page 7
- We are always here to help. Feel free to contact dooraftersale@gmail.com if you have any questions.

You will Receive 4 Parcels in Total

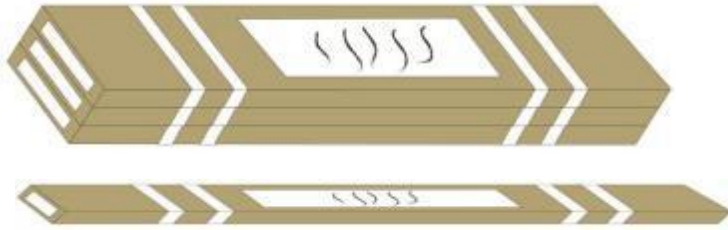

Door Panel Parcel x3

Jamb & Hardware Parcel x1

Jamb & Hardware Package x1, including

6 Jamb Pieces:

Left Jamb x1; Right Jamb x1; Header Jamb x2; Bottom Rail x2

(Header and bottom has been cut to half for safer transportation. Connection plates is provided in the packages)

Hardware List:



Hinge x6



Top Guide
x1



Bottom Roller
x1

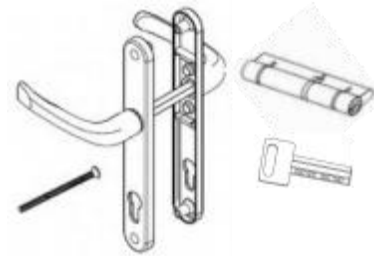

Handle Set & Lock
Set x1



Middle Lock
Set x1



Hinge with Handle
x1



Screws for upper and
lower rail connections
X4



Jamb Top Connection x8
Connector Screws x16



Drainage hole plug
x2



Hinge screws
x72



Frame Screws x25



Allen Key x2

Tools Required



Screw Driver



Tape



Level



Driller

Preparing the Site

Brickwork Opening

When preparing the site, please prepare the brickwork opening to be same as the option you purchase. For example, if you purchase a 96" x 80" door, prepare the opening to be exactly 96" x 80". The door frame will be 9/16" shorter in width and height so that you can fit in the opening and seal properly.

It is essential that all 4 internal surfaces of the brickwork be levelled before installation. Please ensure that all dimensions are correct for installation before proceeding, as the set must be installed square, upright and level into the opening.

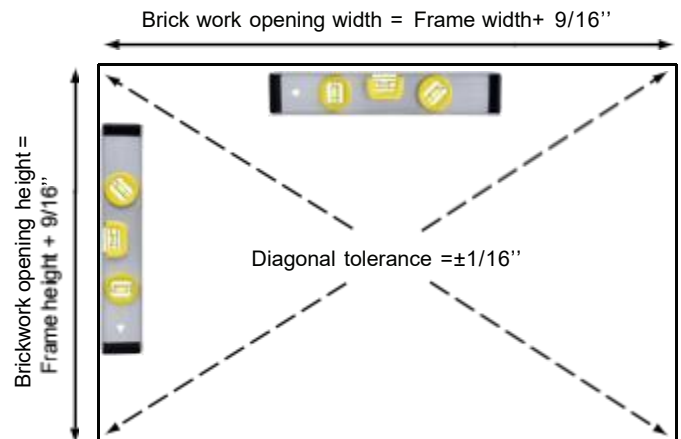

Assembly the Frame

Connect Header Jamb

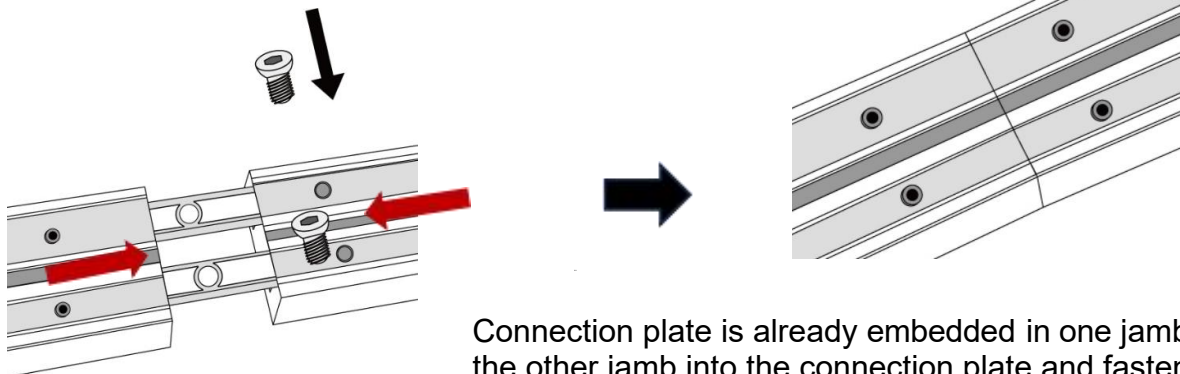

Connection plate is already embedded in one jamb. Slide the other jamb into the connection plate and fasten 2 screws

Connect Bottom Rail

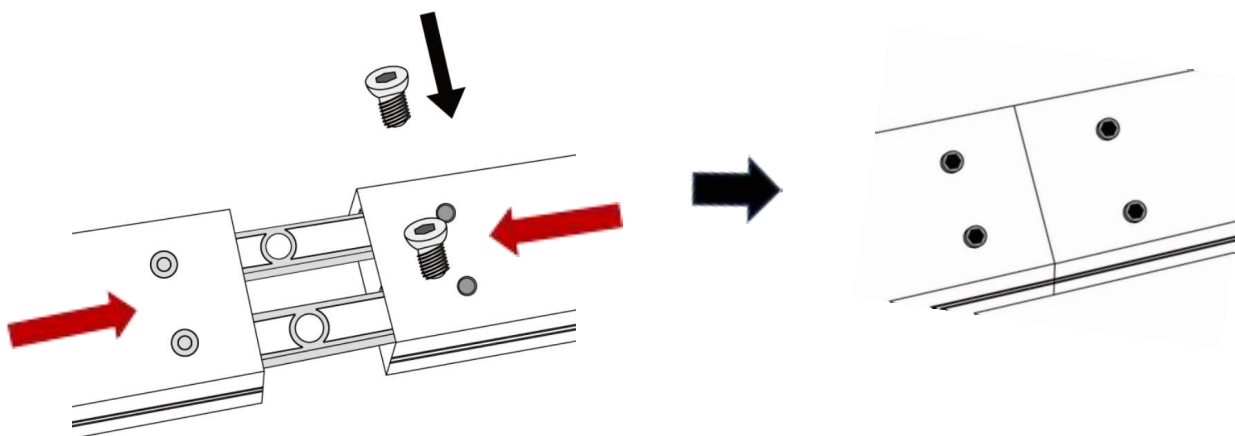

Slide the header and rail together with the connection plate embedded in the frame. Fasten the connector with provided screws.

Assembly the Frame (Cont.)

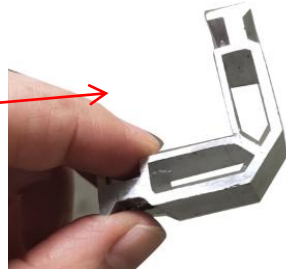
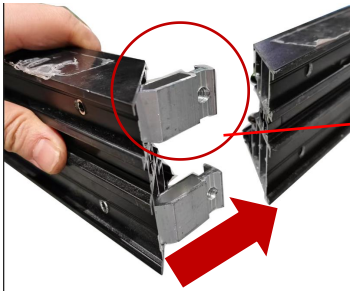

- Insert 2 Jamb Connections to the top jamb, attach the side jamb to the other side of the Connection
- Fasten the 4 screws with Allen Key
- Conduct the steps on all 4 corners to form the below frame

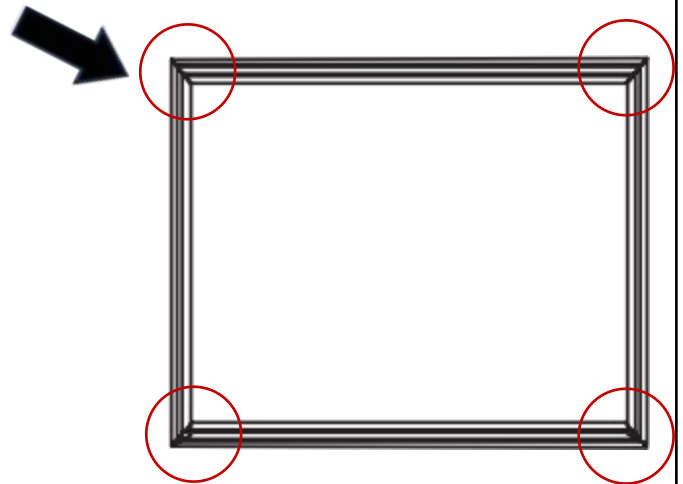

Round-side up

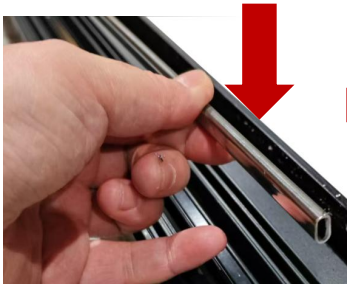

- Insert the track into the bottom rail (you only need to install 2 longer track, shorter has been installed)
- Make sure the round-side face upward and install right beside the installed rail. Knock it in with a hammer

- Our product come with drainage hole plug. Insert the plugs into the drainage holes at bottom
- Drainage hole plug makes the drainage hole a one-way channel, so the rain would not goes into the door through the hole from outside

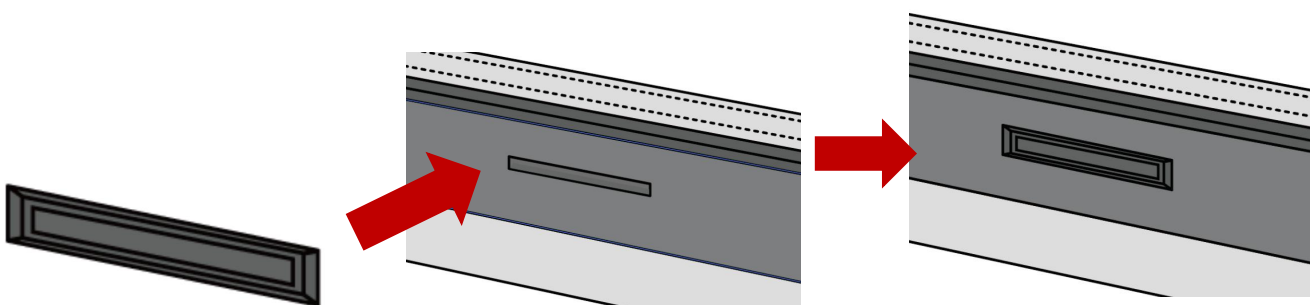

Pro tip: Find the indoor and outdoor side for the frame

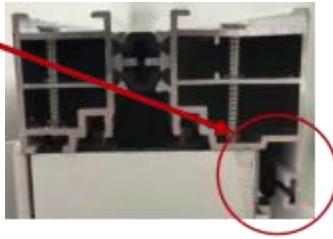

- Take a look at the side or top jambs.
- The jambs with longer wing as circled out in the picture are indoor side. This is to prevent rain from falls in.

Outdoor Side

Install the Frame

1

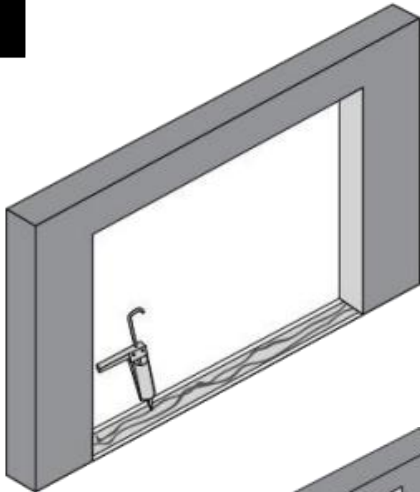

- Place the liquid nail under the track

2

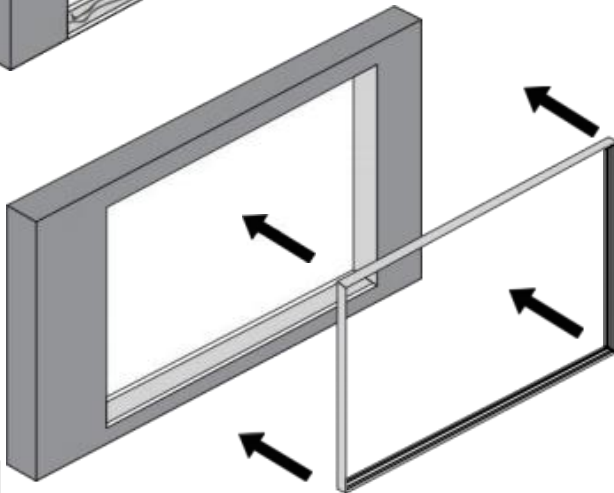

- Put the frame in. Make sure the frame is level and plumb

3

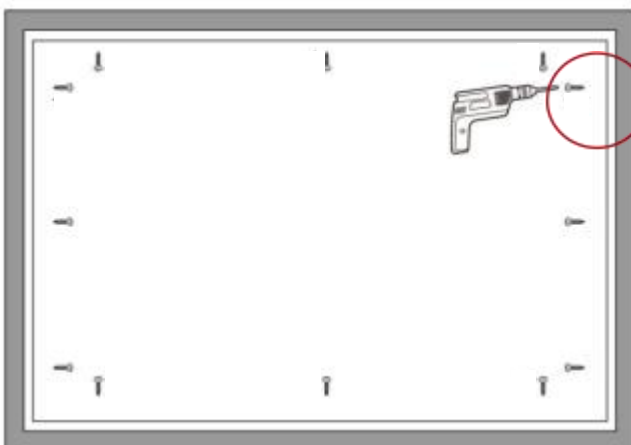

- Use the provided frame screw nail to drill through the frame to the wall. We recommend screw spacing of 20" (extra screws are provided in packages)

Pro Tip: Understand Door & Hardware Position

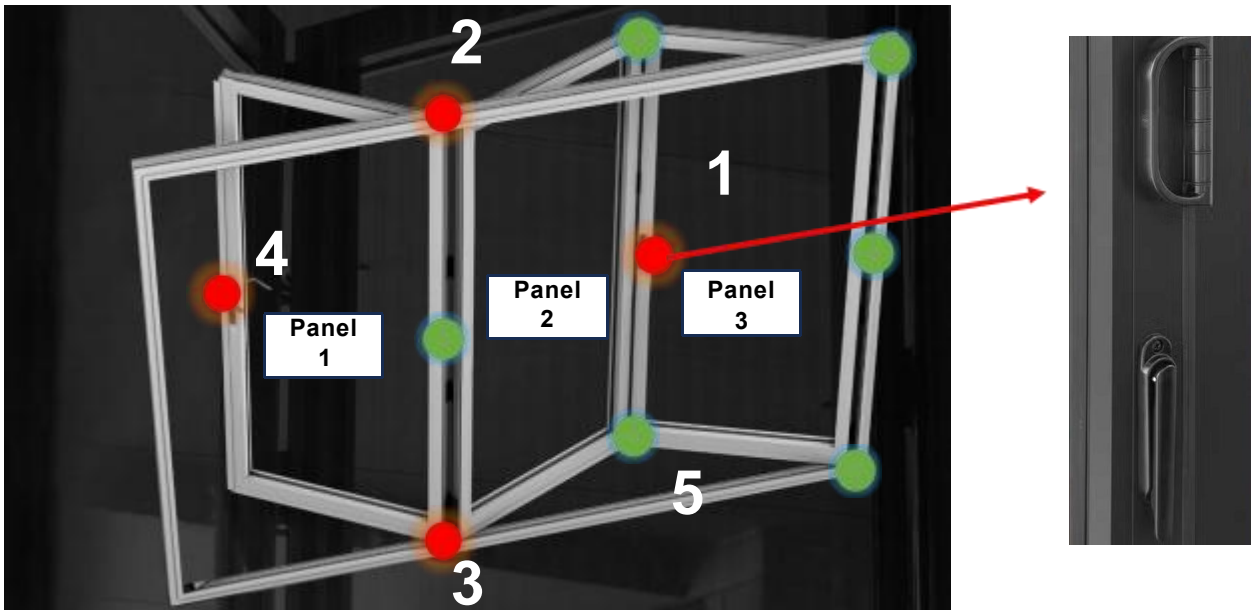

1. Middle Lock Set + Hinge with Handle
2. Top Guide
3. Bottom Roller
4. Handle Set & Lock Set
5. Hinge (6 in total)

Pro tip: Position the Door Correctly According to Label

Face This Side Inside
Put This Side Upward

This is the ① Door Panel
B04-1

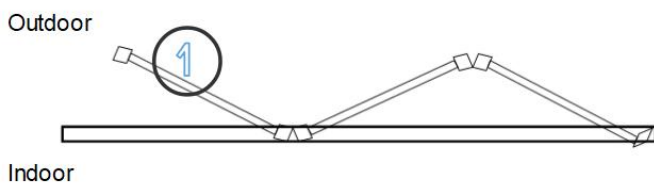

You will find this **door label** on **every door panel**. You can read door **panel #**, which side faced **indoor**, and which side **face upward** based on the label

Install Folding Door Panels (Left Opening As an Example)

1

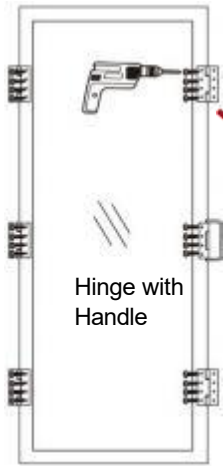

- Attach 5 hinges and 1 hinge with handle to **Panel 3**

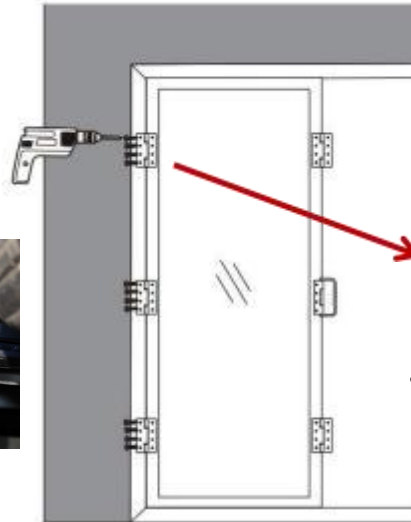

- Attach the **Panel 3** to the frame using the other side of the hinges

2

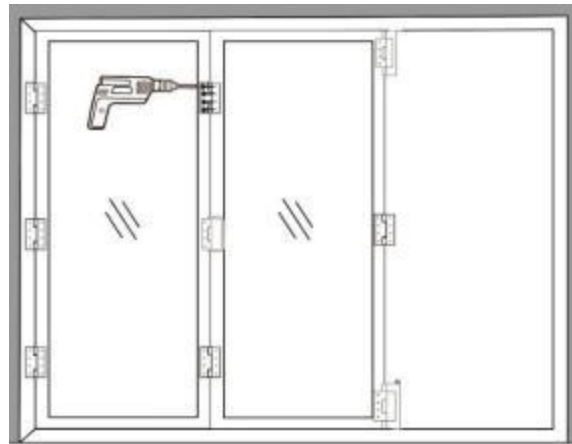
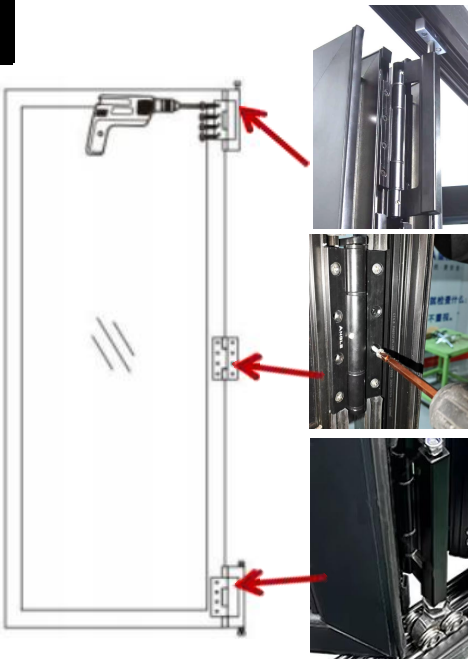

- Install the top and bottom roller, and a hinge to **Panel 2**
- Put the top and bottom roller in the track. Connect the **Panel 3** and **Panel 2** with the hinges already installed on the **Panel 3**

3

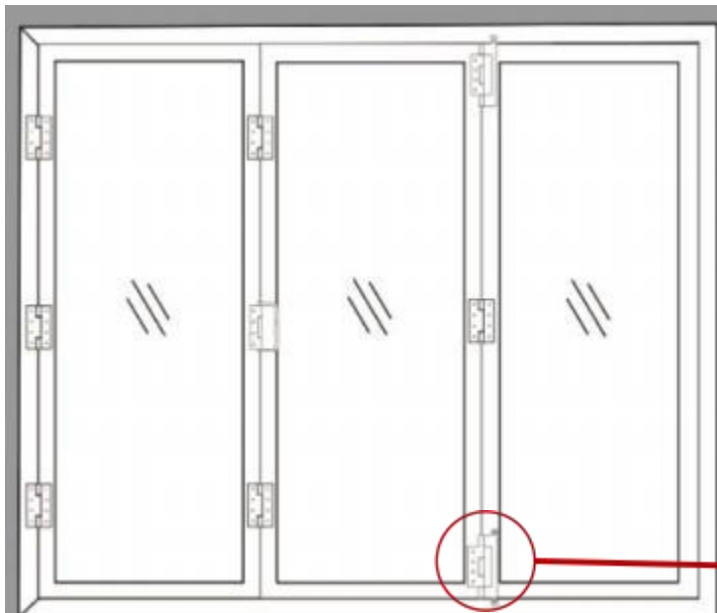

Connect the **Panel 2** to **Panel 1** with the already installed top and bottom roller and hinges on the **Panel 2**

Pro tip:

- Examine whether the 3 doors are level
- You can adjust the height of panels by the bottom roller illustrated as below with a wrench

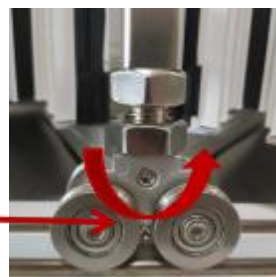

Install Locks

Middle Lock

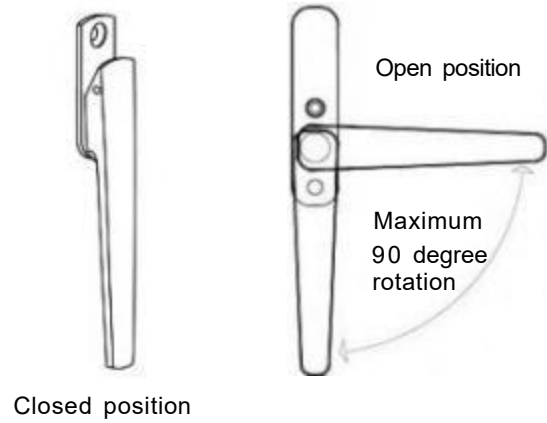

- Rotate the lock to reveal screw holes
- Fasten to door with provided screws

Handle Set & Lock Set

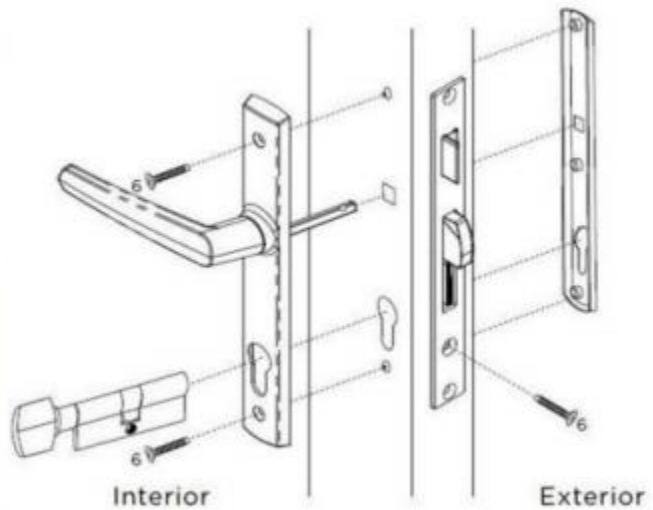

Our lock is an upgraded 3-position lock. When closed, pull the handle up and it will initiate lock at top and bottom simultaneously

Recommended sealing

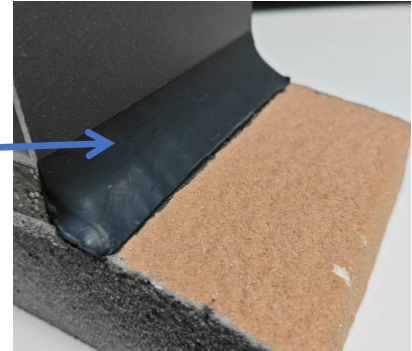

After installation, we recommend to properly seal the door both indoor and outdoor to improve weatherproof, pest-resistant performance and enhance energy efficiency. We recommend to use silicone sealant. Below instructions are for reference and we recommend to follow the instructions of sealant manufacturer if there's any discrepancy.

- 1) Start with a clean surface: make sure you have a clean work surface by wiping it down with isopropyl alcohol
- 2) Cut the sealant cartridge: prepare your sealant by cutting the tip of the cartridge. Cut the cartridge tip at a 45-degree angle
- 3) Apply sealant: maintain a relaxed, confident grip and steady speed as you apply the sealant. Run a bead between the door frame and the home's siding, starting from the top corner and working down to the bottom corner. If you can't make it in one pass, it's ok to readjust your grip and start where you left off. Seal around everywhere there are gaps between the frame or casing of the door and the rest of the house, including the door sill.
- 4) Tool the bead: Use a caulk tool or your finger to tool the sealant bead until it's smooth, before the sealant starts to cure
- 5) Let sealant cure completely

Frequently Used Adjustments

- There are some cases the frame may end up not fully square, e.g. due to unflat floor or wall. This may lead to un-smooth rolling during usage
- Our hardware are able to provide certain level adjustments to address the issue. Below are 2 frequently used adjustments to follow. You can also contact us for more complex solutions

Un-smooth/ Too smooth rolling on top: Adopt top guide adjustment

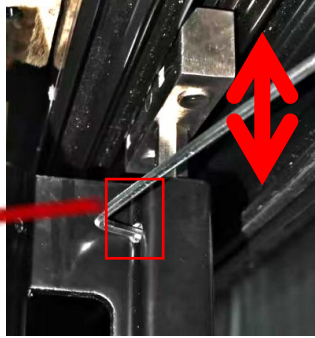

- Loose 2 screws pointed out in the picture of the top guide with allen key
- The wheels can be moving up or down slightly (i.e. the red rectangle part is extendable). Wheels moving up lead to more friction, and moving down lead to less friction
- Fasten the 2 screws after the wheels has been adjusted to proper position



Slabs not level, scratch the bottom rail or cannot fully close: Adopt bottom roller adjustment



- Rotate both screws in the drawn position will push the slabs up, and pull the slabs down when you rotate the other direction
- Adjust the wheels so that the 2 slabs adjacent to bottom roller are fully level