

ASSEMBLY INSTRUCTIONS

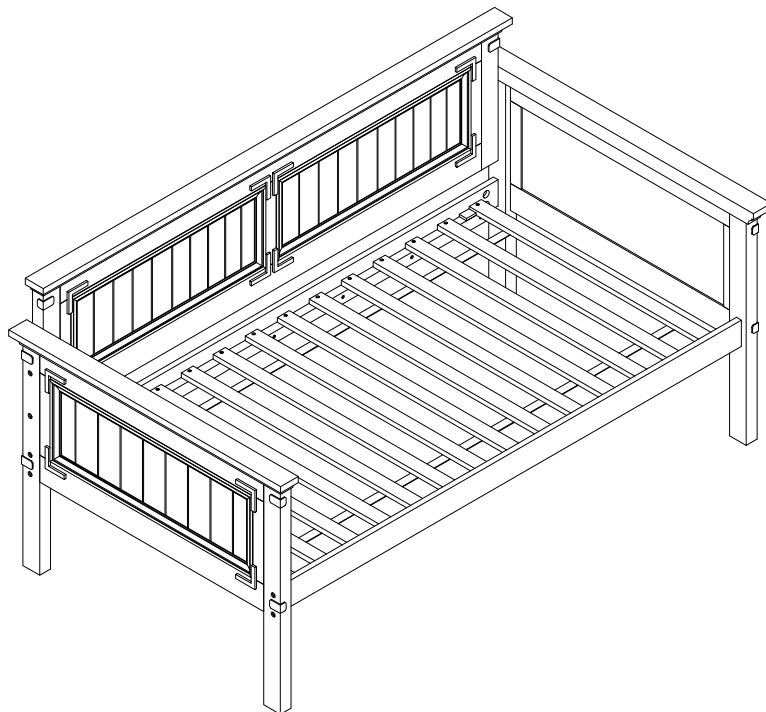

Fine Furniture for every stage of life

(B1&B2)
Twin Daybed

REVISION 0 : 09/06/2017
REVISION 1 : 11/08/2019

ASSEMBLY INSTRUCTIONS

ASSEMBLY TIPS:

1. Remove hardware from box and sort by size.
2. Please check to see that all hardware and parts are present prior to start of assembly.
3. Please follow attached instructions in the same sequence as numbered to assure fast & easy assembly.



WARNING!

1. Don't attempt to repair or modify parts that are broken or defective. Please contact the store immediately.
2. This product is for home use only and not intended for commercial establishments.

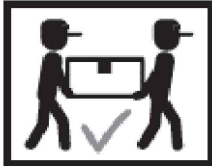

ASSEMBLY TIME

30 MINUTES

PARTS IDENTIFICATION

B1 (BOX 1)

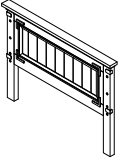
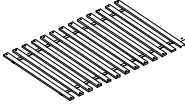
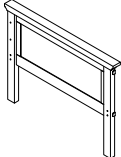





A	LEFT SIDE FRAME		1PC	C	ROLL SLAT (13PCS)		1SET
B	RIGHT SIDE FRAME		1PC				

B2 (BOX 2)

D	BED RAIL		2PCS	E	BACK PANEL		1PC
---	----------	---	------	---	------------	---	-----

HARDWARE IDENTIFICATION

B2 (BOX2) - HARDWARE PACK IS LOCATED IN (B2)

1	LONG BOLT (1/4 x 90mm Φ 15 - BLK)		8PCS	4	FLAT HEAD SCREW (4 x 35mm - BLK)		8PCS
2	HALF ROUND NUT (1/4 x 22mm - BLK)		8PCS	5	WOOD DOWEL (8 x 30mm)		8PCS
3	SHORT BOLT (1/4 x 70mm Φ 15 - BLK)		4PCS	6	ALLEN WRENCH (4MM - BLK)		8PCS

NOTE:

Phillips head screw driver is required in the assembly process; however, manufacturer does not provide this item.

ASSEMBLY INSTRUCTIONS

STEP 1

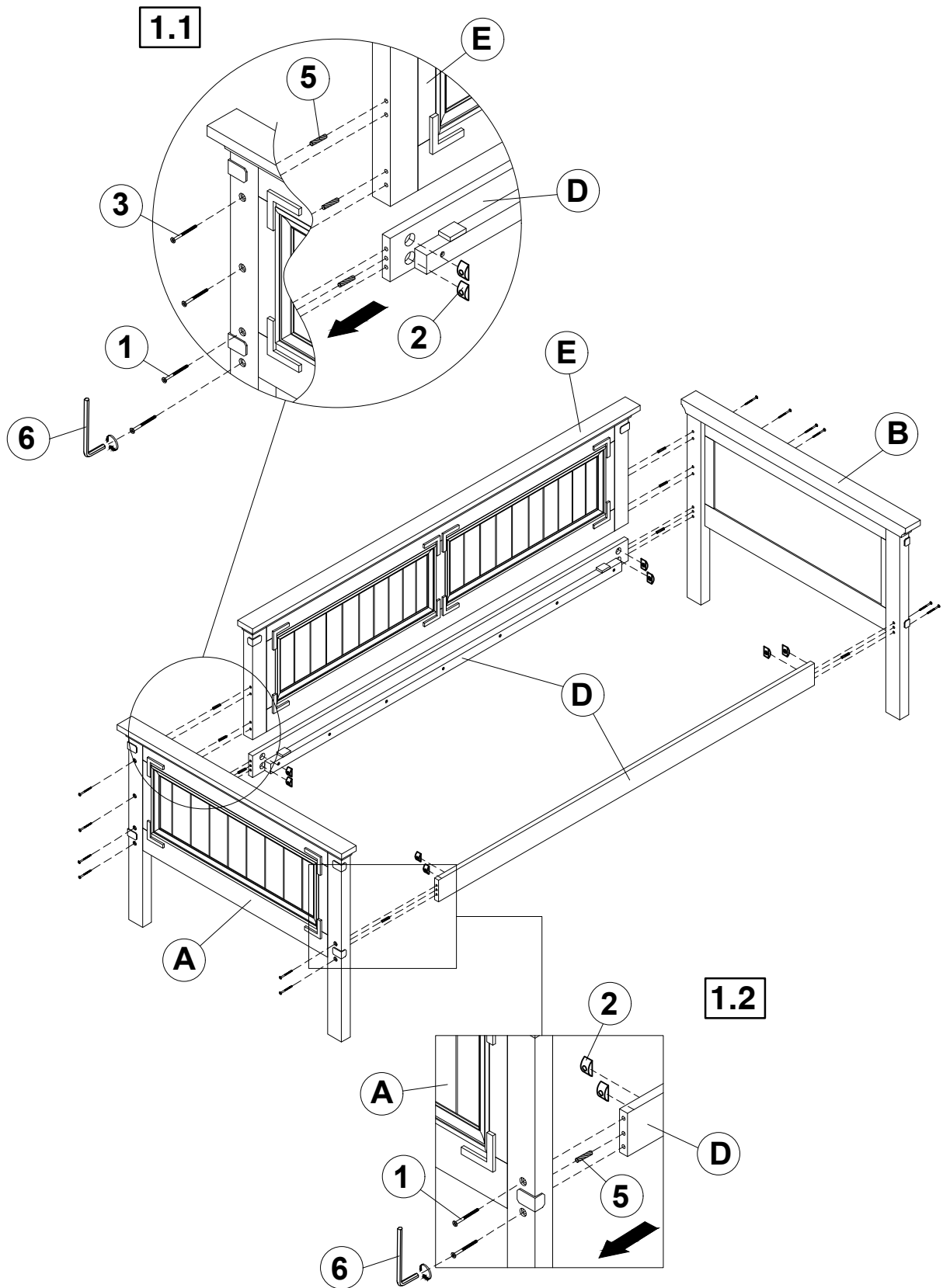

ASSEMBLY INSTRUCTIONS

STEP 2

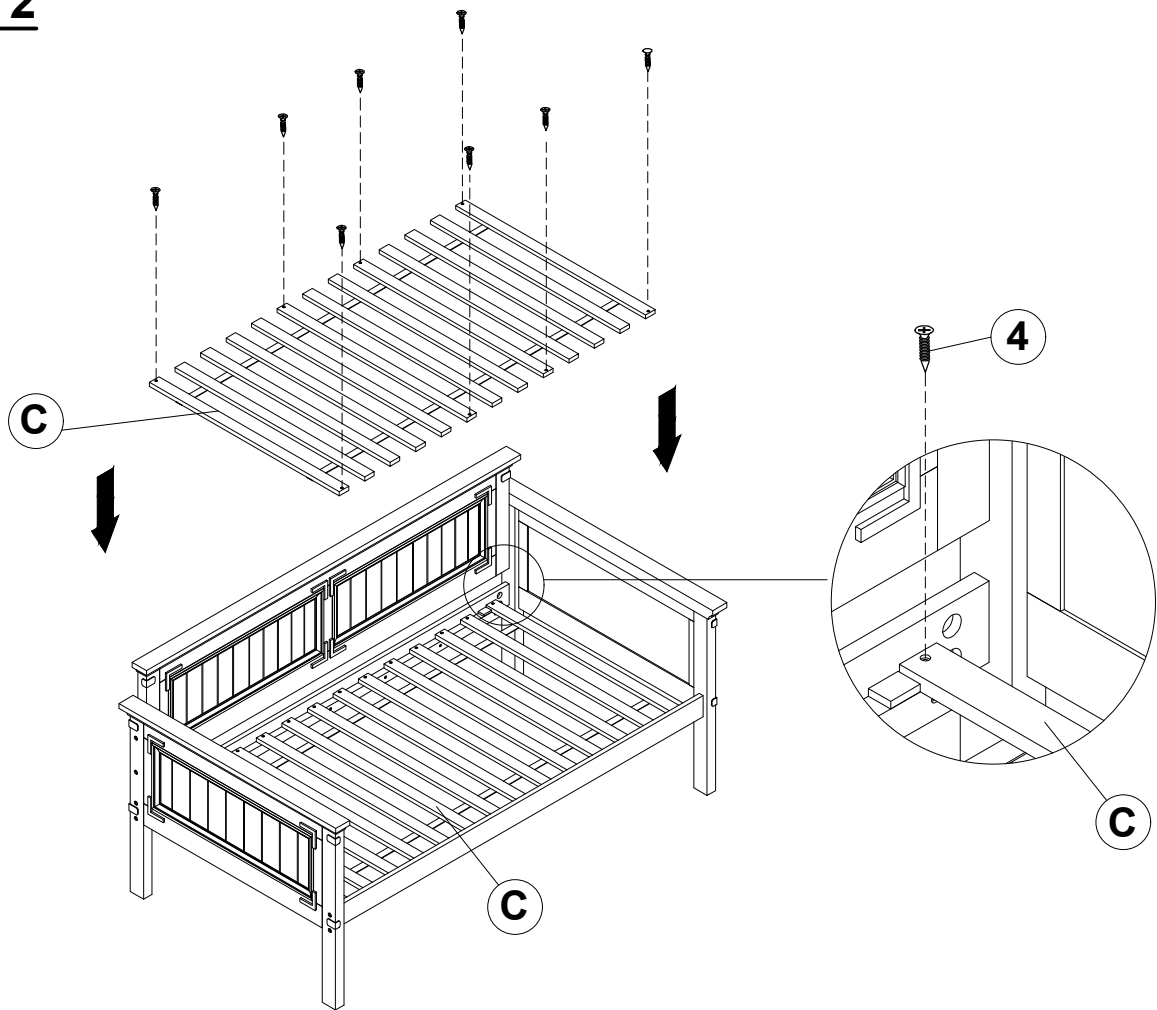

STEP 3

COMPLETE

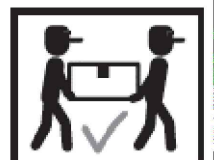
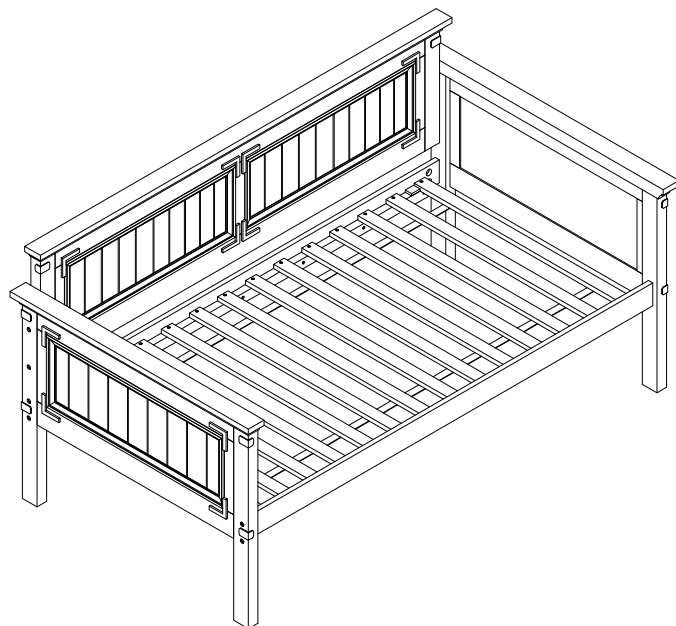

Inner Size: 76.50"W x 39.25"D

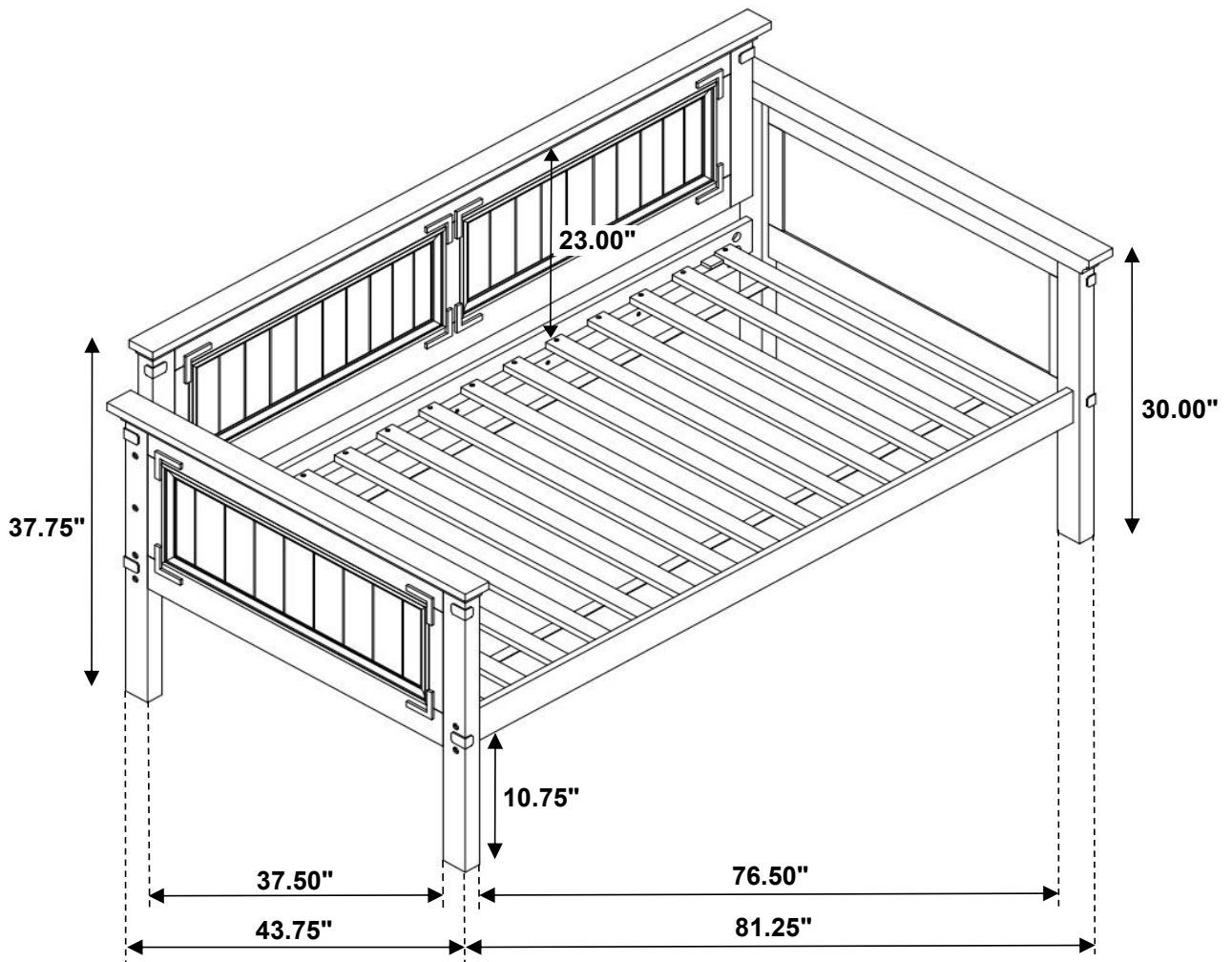

Note: Dimension tolerance $\pm 5\%$