















ASSEMBLY INSTRUCTIONS

Don't tighten any bolts until all bolts on a step have been started!

Thank you for purchasing this quality product. Be sure to check all packing material carefully for small parts, which may have come loose inside the carton during shipment. Identify and count all parts and compare with the HARDWARE LIST below.

NO.	PARTS LIST	Q'TY
A	 Stool back	1
B	 Linen Fabric Seat	1
C	 Left Leg	1
D	 Right Leg	1
E	 Left Stretcher	1
F	 Right Stretcher	1
G	 Front Stretcher	1

NO.	HARDWARE LIST	Q'TY
1	 1/4"x3"	4
2	 1/4"x2"	4
3	 1/4"x1-1/2"	1
4	 1/4"	9
5	 1/4"x19mm	9
6	 8*38mmL	6
7	 Allen Wrench	1

STEP 1:

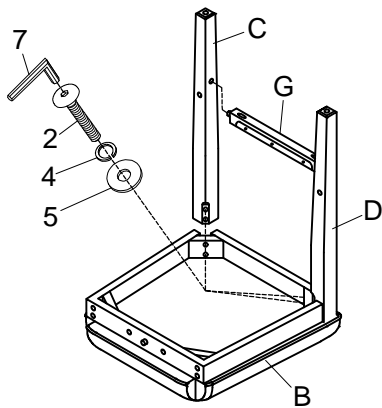

1. Loosely attach the left leg(C) and Right leg(D) to the Linen Fabric Seat(B), using Bolts(7+2+4+5) to tighten, as shown.

STEP 2:

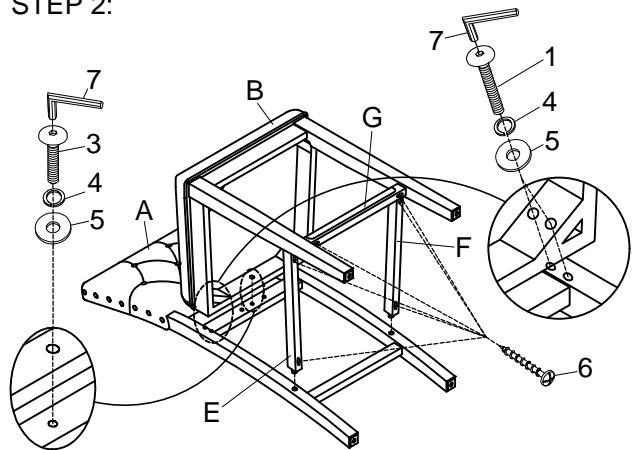

1. Loosely attach the Linen Fabric Seat (B) to the Stool Back(A), using Bolts(7+3+4+5) and Bolts(7+1+4+5) to tighten, as shown.
 2. Attach the Front/Back stretcher(G) and Right/left stretcher(E/F) to the legs, using Screw(6) and a phillips head screwdriver to tighten, as shown.

STEP 3:

1. Right side up the stool.
2. It's complete for using.

Caution: 1. All bolts must be tightened mandatorily in each step.
 2. It is also recommended to periodically check bolts and re-tighten as needed.

