











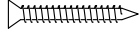
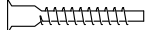
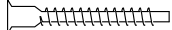

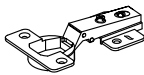

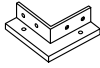
HARDWARE LIST			QTY (pcs)
A2		Screw m3.5 x 14mm	74
A4		Screw m3.5 x 20mm	4
A7		Screw m4 x 30mm	4
A17		Crosshead Screw m6.3 x 40mm	14
A18		Crosshead Screw m6.3 x 50mm	4
C5		Square Lock Set	1 Set
D4		Wood Dowel 6 x 25mm	8
E5		Soft Closing Hinge 5/8	6
E21		Anti-Tipping Pack	1 Set
H21		Handle 128mm	2

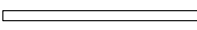
L2		Plastic Leg L Shape	4
N1		Allen Key	1
N3		Nail	35 (+3)
P		Hanging Steel Pipe 18mm x 727mm	1
P1		Hanger 21	1
Q4		Plastic Shelf Support with Steel Pin	12
R1		L Bracket	2
S1		Door Catches	1
S2		Door Stopper	1
Y		Crosshead Cover	14

Place your screw on top of the scale to identify their size.

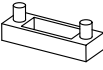
A2

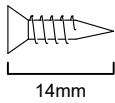

Screw m3.5 x 14mm

A2

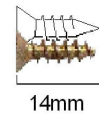

Screw
m3.5 x 14mm

A4

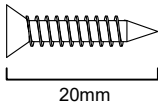

Screw m3.5 x 20mm

A4

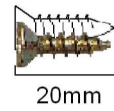

Screw
m3.5 x 20mm

A7

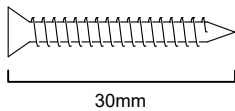

Screw
m4 x 30mm

A7

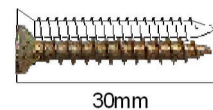

Screw
m4 x 30mm

A17

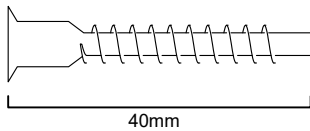

Crosshead Screw
m6.3 x 40mm

A17

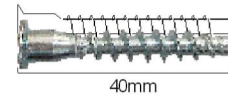

Crosshead Screw
6.3 x 40mm

A18

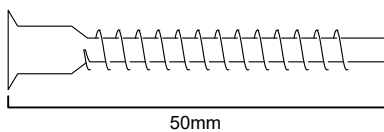

Crosshead Screw
m6.3 x 50mm

A18

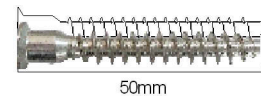

Crosshead Screw
6.3 x 50mm

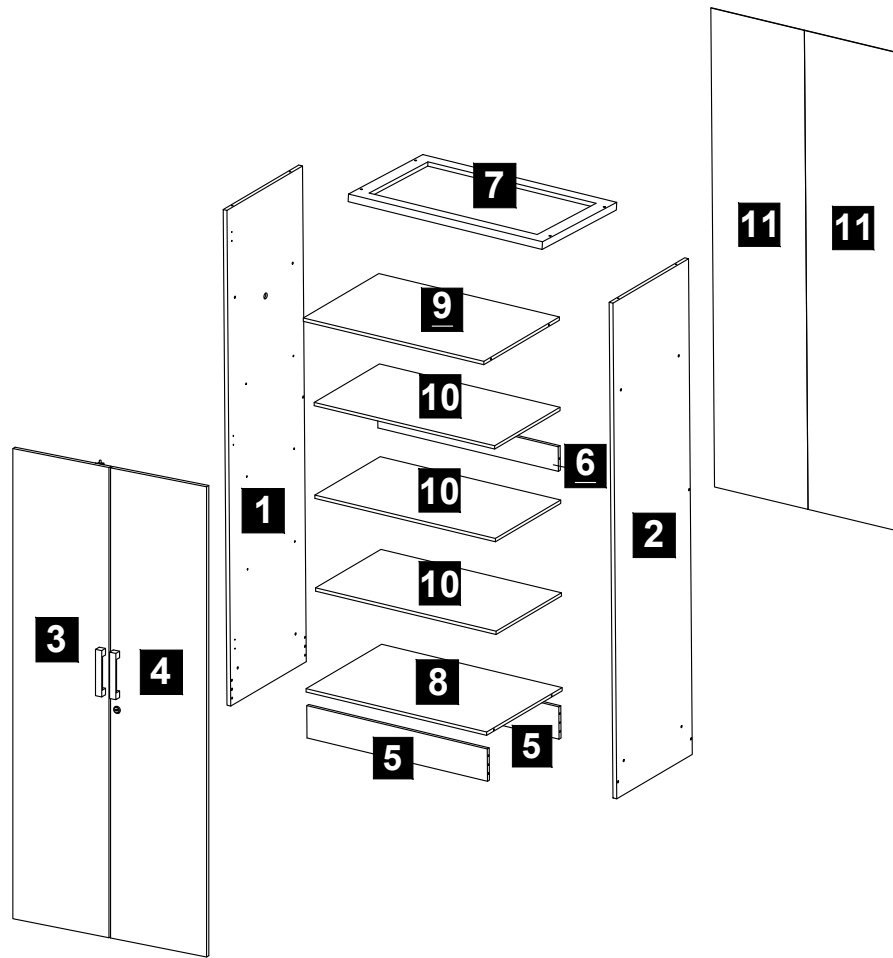

Parts List

1	Side Panel (L)	1 pc
2	Side Panel (R)	1 pc
3	Door Panel (L)	1 pc
4	Door Panel (R)	1 pc
5	Crossbar Panel	2 pcs
6	Small Crossbar	1 pc
7	Top Panel	1 pc
8	Base Panel	1 pc
9	Big Shelf Panel	1 pc
10	Shelf Panel	3 pcs
11	Backboard	2 pcs





EACH PART IS LABELLED ACCORDING TO THE PARTS LIST

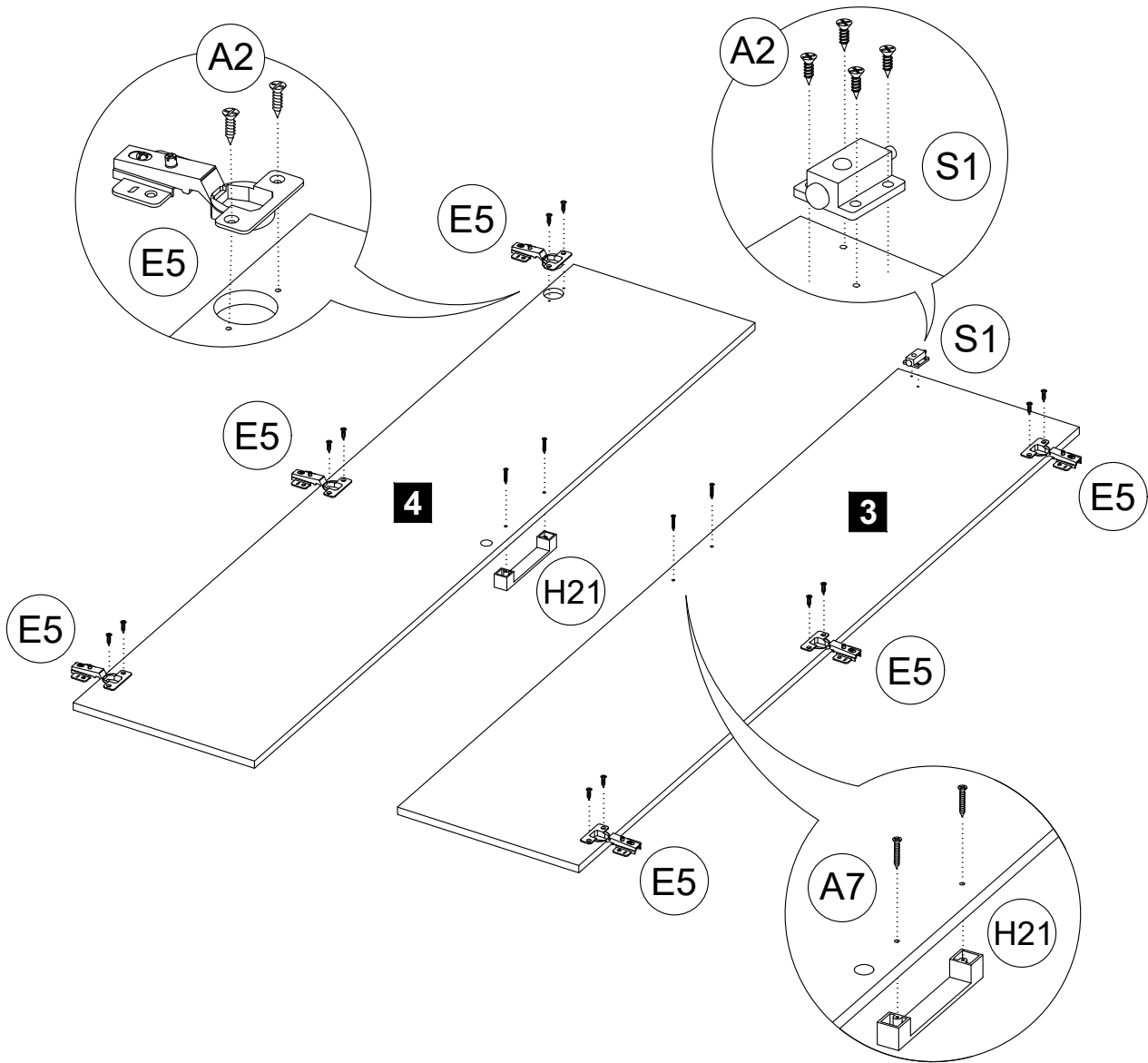

Before starting assembly
please verify if all parts and
hardware are included

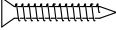

STEP 1



A2		Screw m3.5 x 14mm	16 pcs
A7		Screw m4 x 30mm	4 pcs
E5		Soft Closing Hinge 5/8	6 pcs
H21		Handle 128mm	2 pcs
S1		Door Catches	1 pc

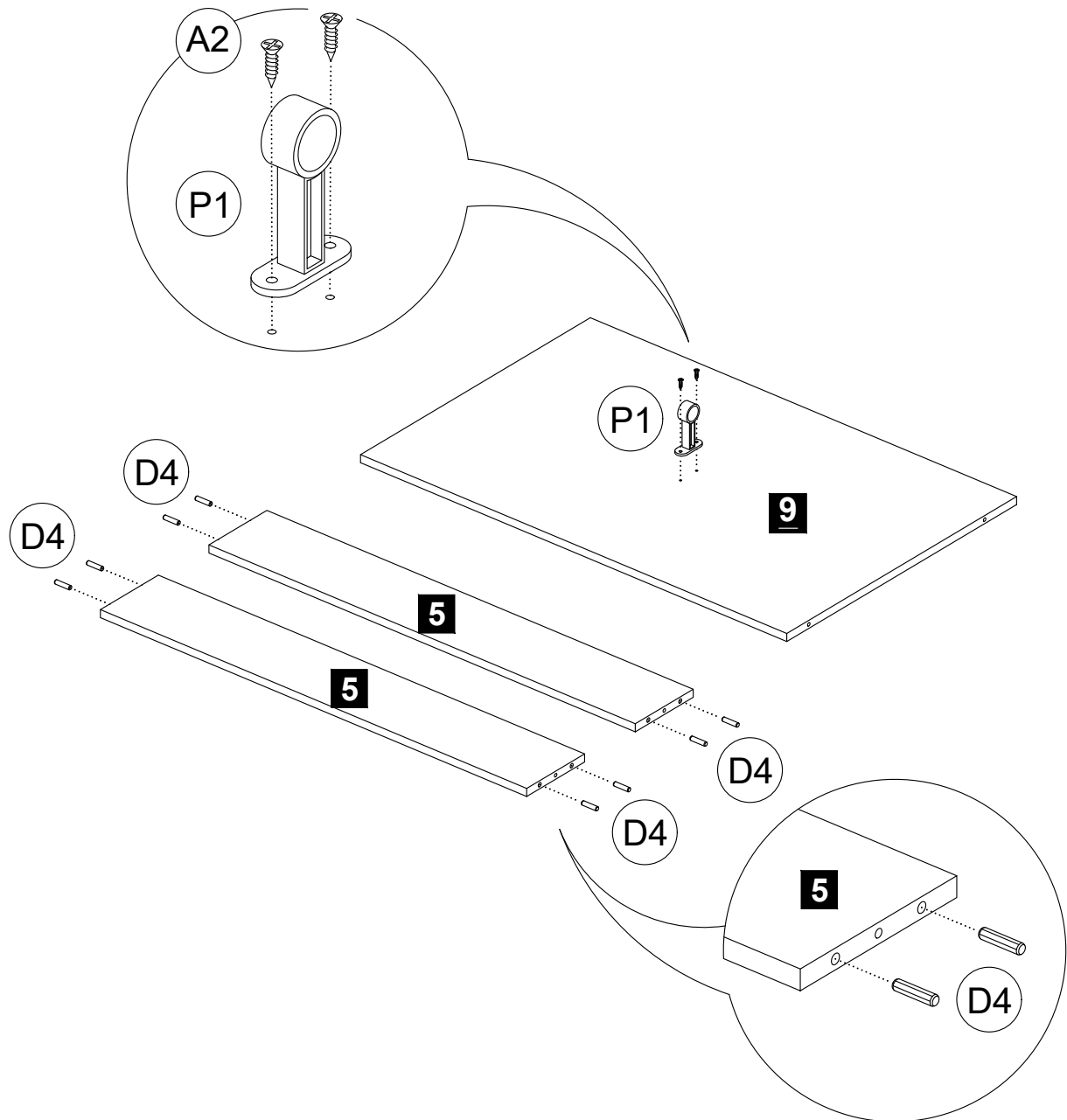

STEP 2



A2		Screw m3.5 x 14mm	2 pcs
D4		Wood Dowel 6 x 25mm	8 pcs
P1		Hanger 21	1 pc

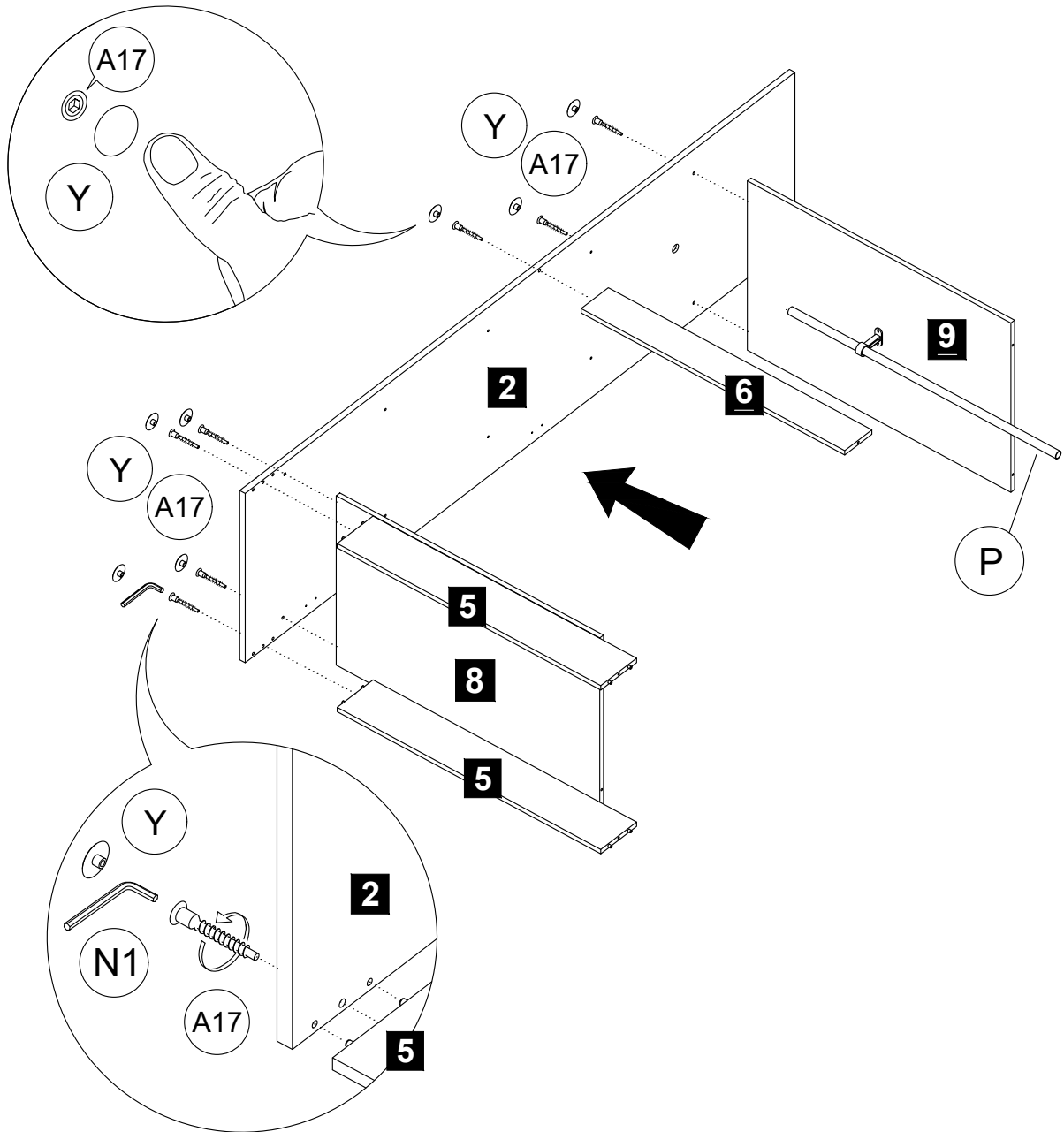

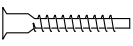
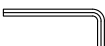
STEP 3



A17		Crosshead Screw m6.3 x 40mm	7 pcs
N1		Allen Key	1 pc
P		Hanging Steel Pipe 18mm x 727mm	1 pc
Y		Crosshead Cover	7 pcs

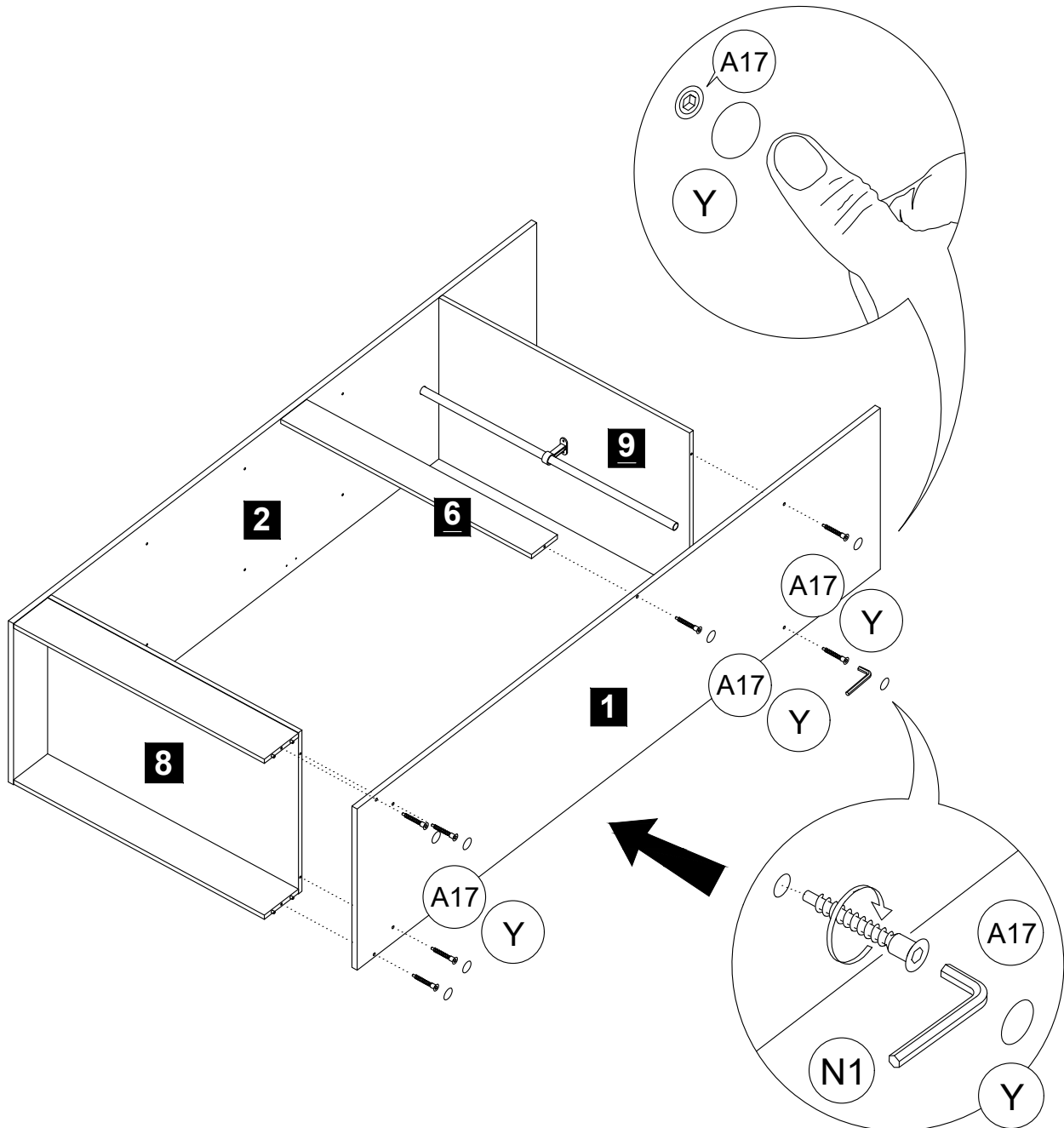

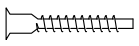
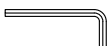
STEP 4



A17		Crosshead Screw m6.3 x 40mm	7 pcs
N1		Allen Key	1 pc
Y		Crosshead Cover	7 pcs

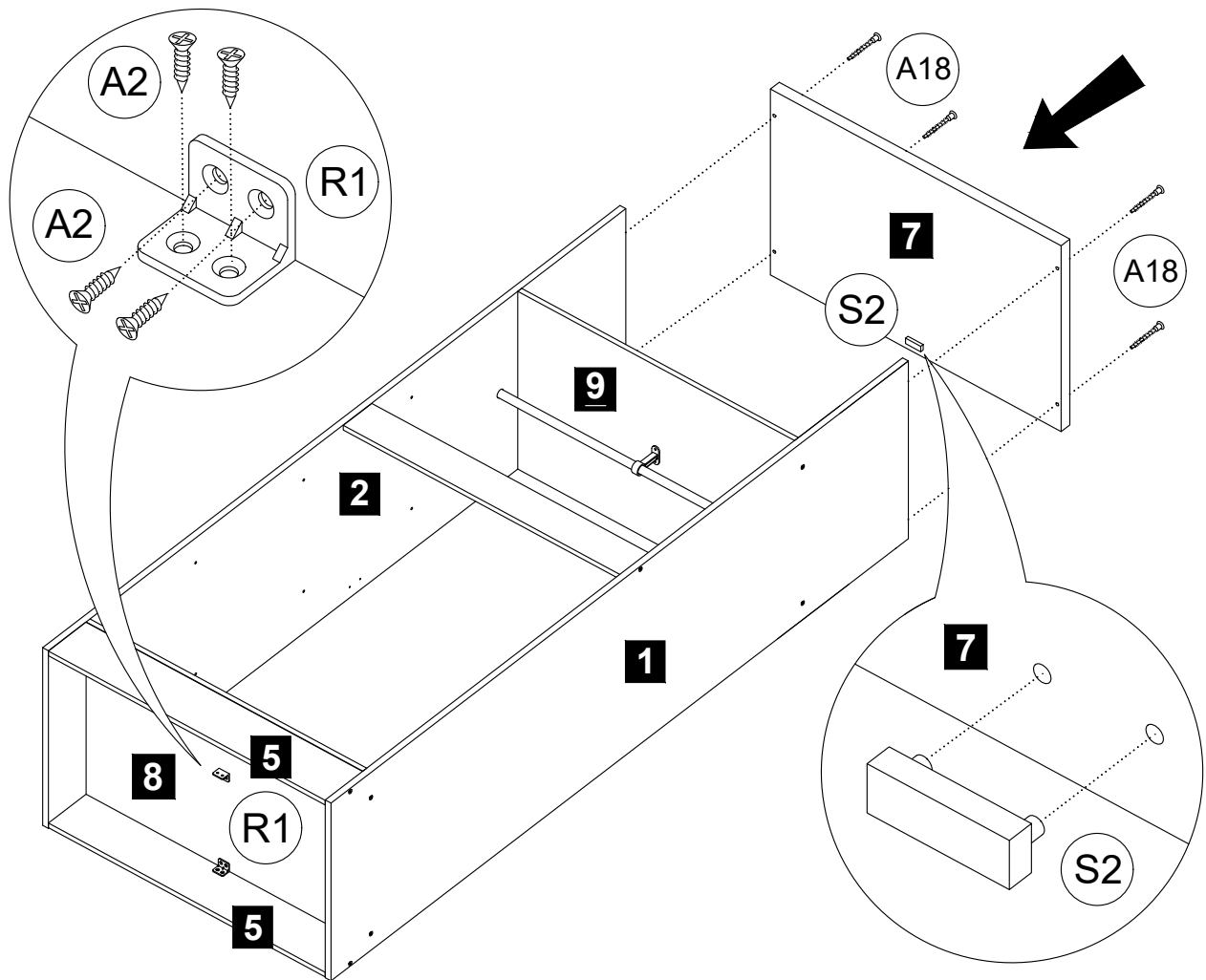

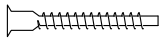
STEP 5

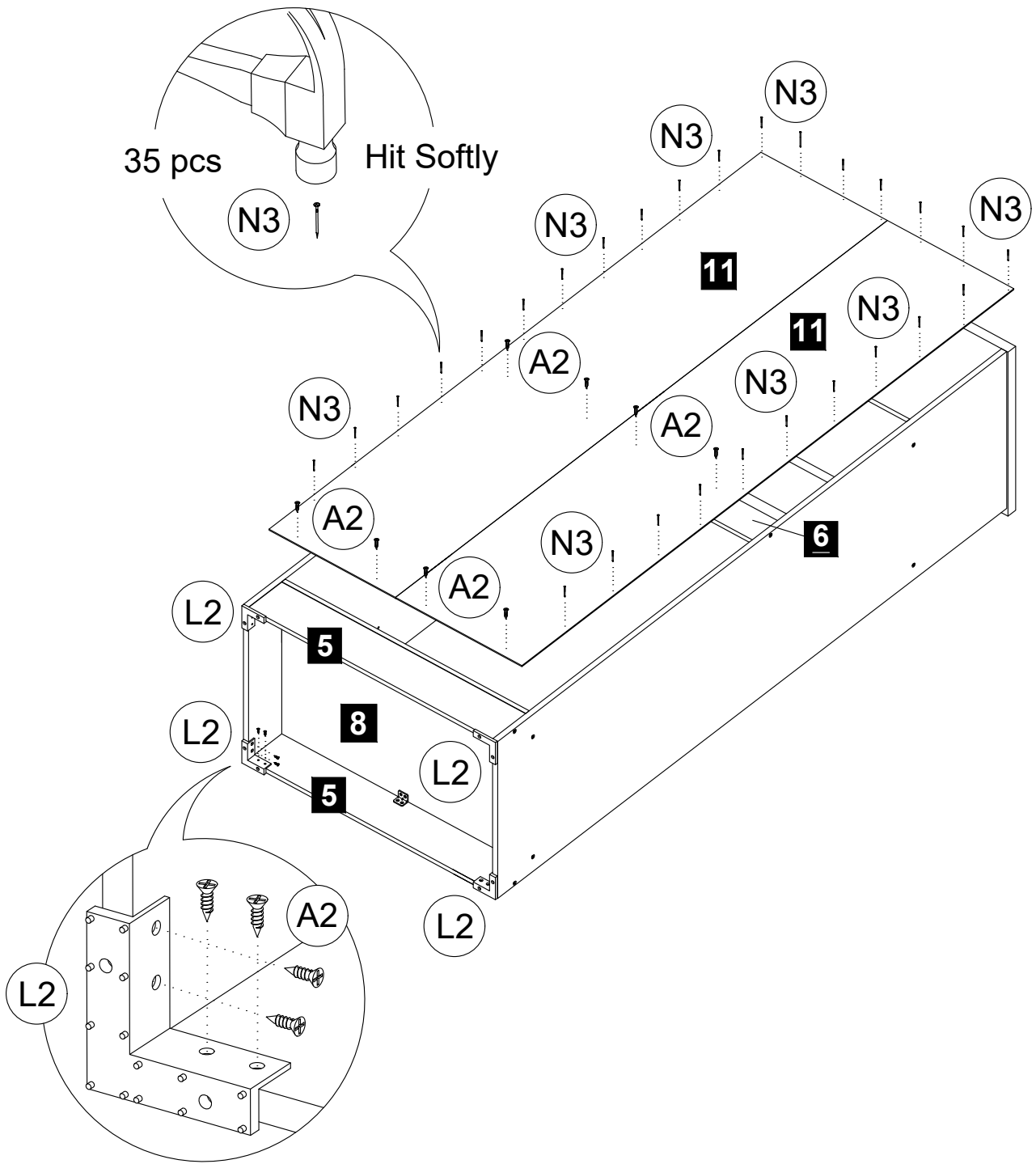

A2		Screw m3.5 x 14mm	8 pcs
A18		Crosshead Screw m6.3 x 50mm	4 pcs
R1		L Bracket	2 pcs
S2		Door Stopper	1 pc

STEP 6





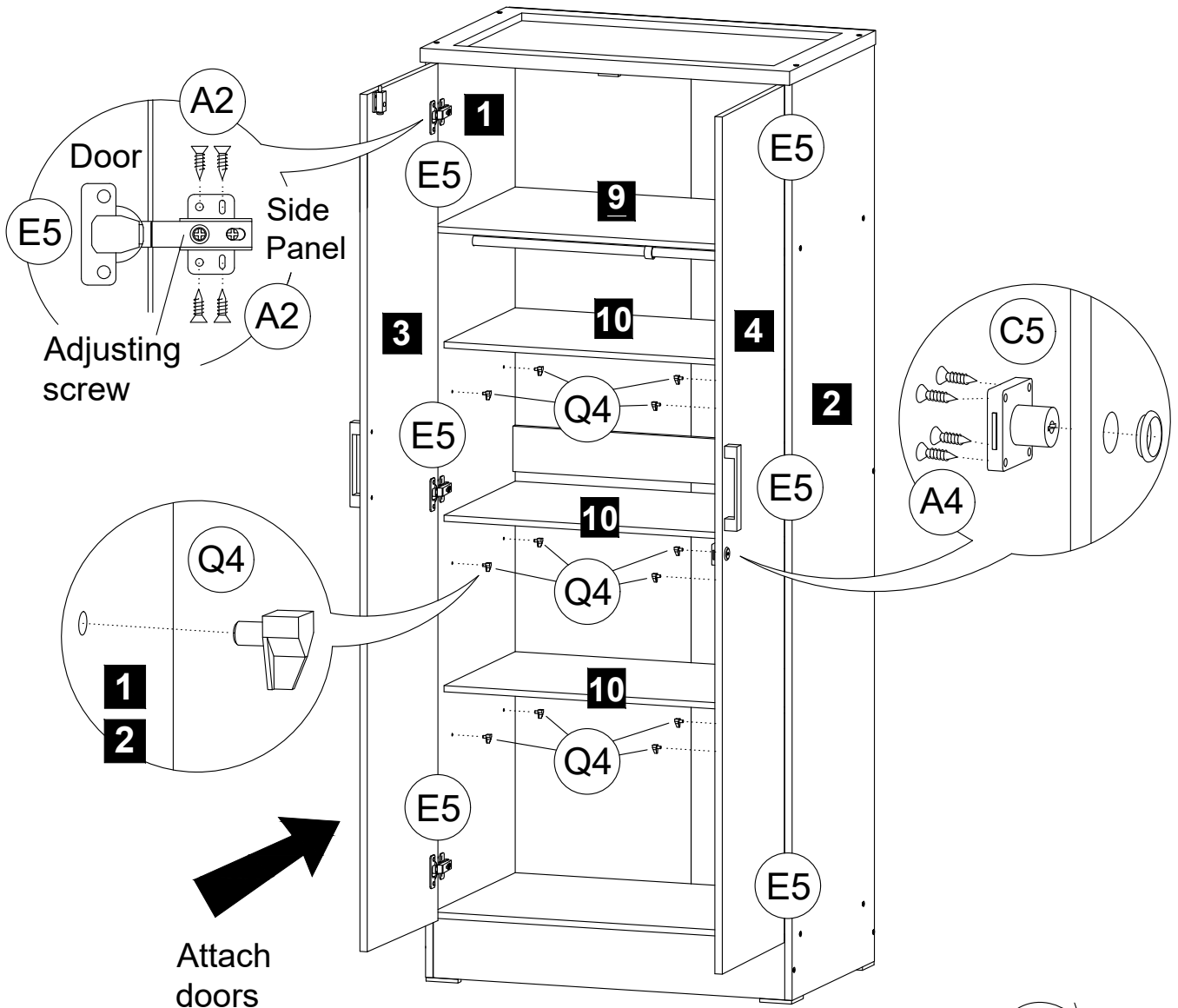

A2		Screw m3.5 x 14mm	24 pcs
L2		Plastic Leg L Shape	4 pcs
N3		Nail	35 (+-3) pcs

STEP 7



Attach doors

Stand up

A2		Screw m3.5 x 14mm	24 pcs
A4		Screw m3.5 x 20mm	4 pcs
C5		Square Lock Set	1 set
E5		Soft Closing Hinge 5/8	6 pcs
Q4		Plastic Shelf Support with Steel Pin	12 pcs

FITTING OF TIPOVER RESTRAINT KIT

The Tipover Restraint Kit is highly recommended for this piece of furniture.

(Please take this into extra consideration around young toddlers and children)

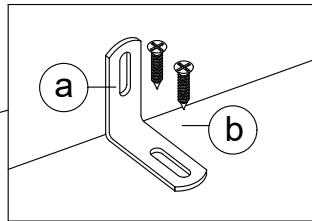
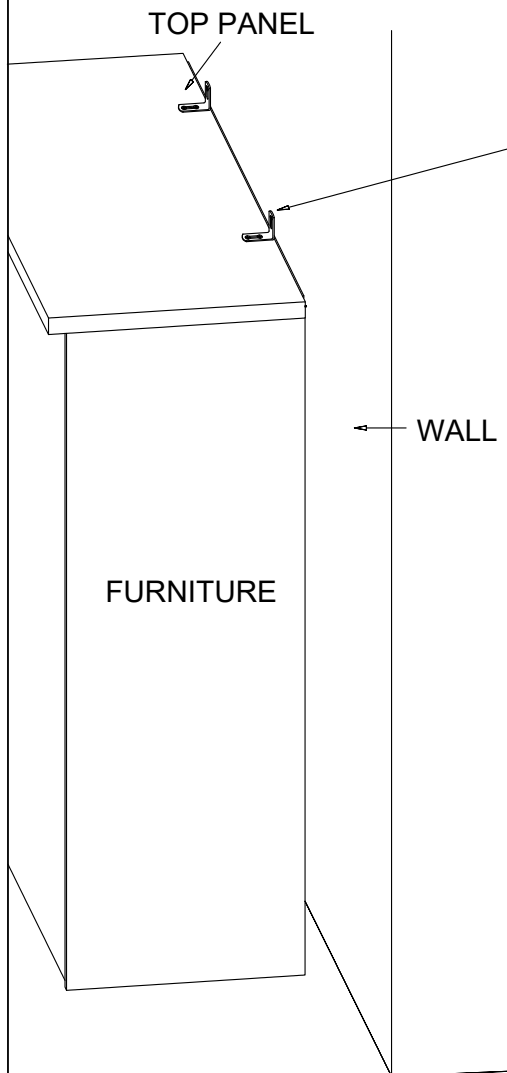

STEP 1:

- Attach the mounting bracket (a) to the top panel near the edge of the side of the unit.

- Screw (b) through the two holes of (a).

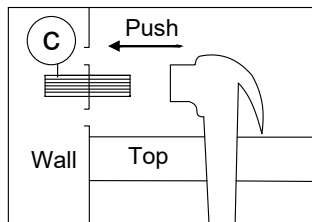

STEP 2:

- Insert the wall plug (d) into the wall behind the unit.

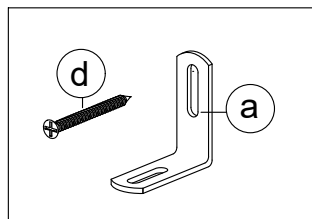

STEP 3:

- Attach to the mounting bracket (a) to the wall plug (c) through the hole by using (d).

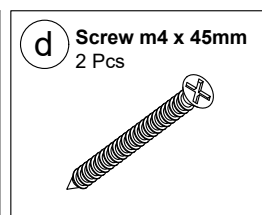
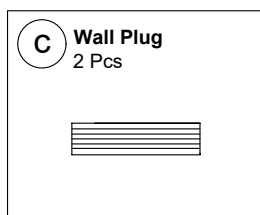
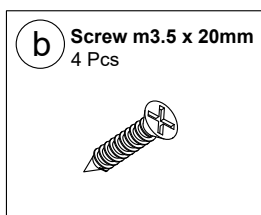
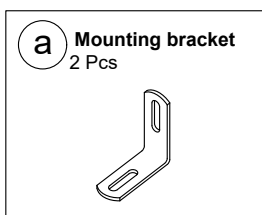

THANK YOU

We hope you enjoy your new purchase.

We have personally inspected this product.

Thank you