

# ASSEMBLY INSTRUCTIONS

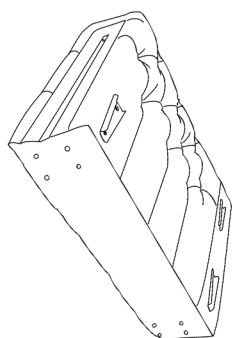

**A: Left Arm x 1pcs**

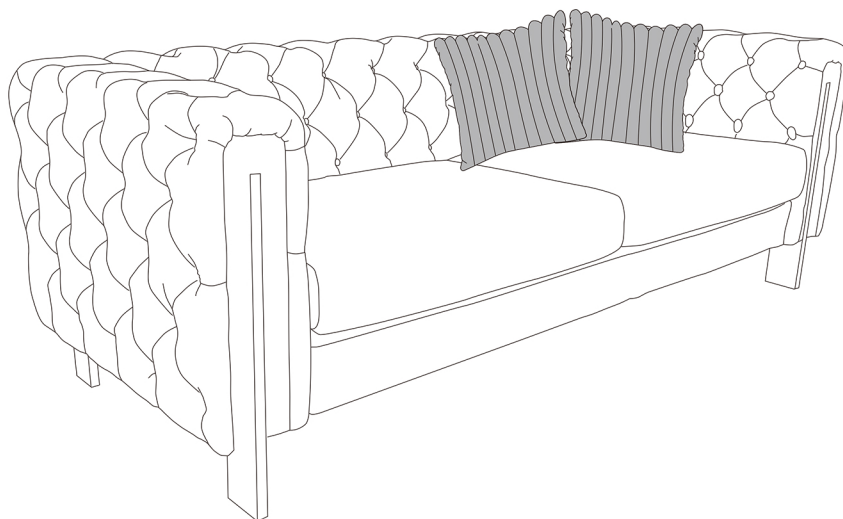
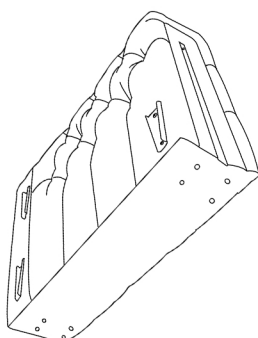

**B: Right Arm x 1pcs**

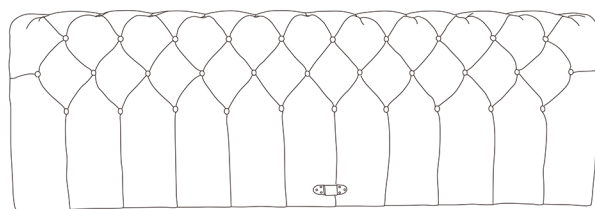

**C: Sofa Back x 1pcs**

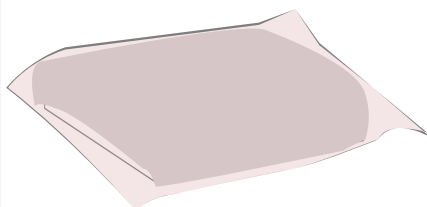

**D: Seat Cushion x 2pcs**



**E: Seat cushion cover x 2pcs**



**F: Pillow x2pcs**



**G: Bottom Board x 1pcs**

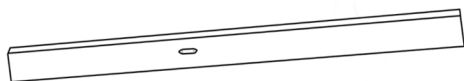

**H: Front Board x 1pcs**



**I: Center Bar x 1pc**



**J: Side Bar x 2pcs**

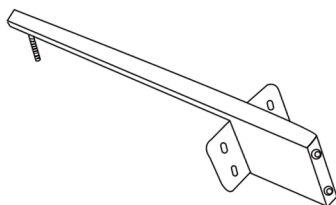

**K: Front leg x2pcs**

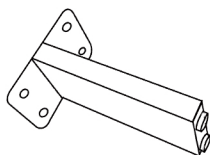

**L: Back leg x2pcs**

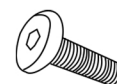

**M: Screw 20MM x18pcs**

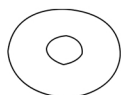

**N: Washer  
x 22pcs**

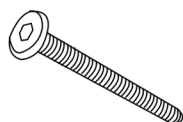

**O: Screw 60MM  
x4pcs**

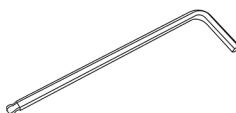

**P: Hexagon Socket  
Screw Keys x1pcs**

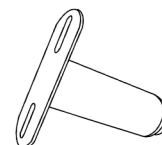

**Q: adjustable middle leg  
x 1pcs**

P.S: insert the long bolt into the hole,at the same time there is some distance between the leg and the bottom of the arm,then push the leg from the bottom to the end.

① insert the long bolt into the hole

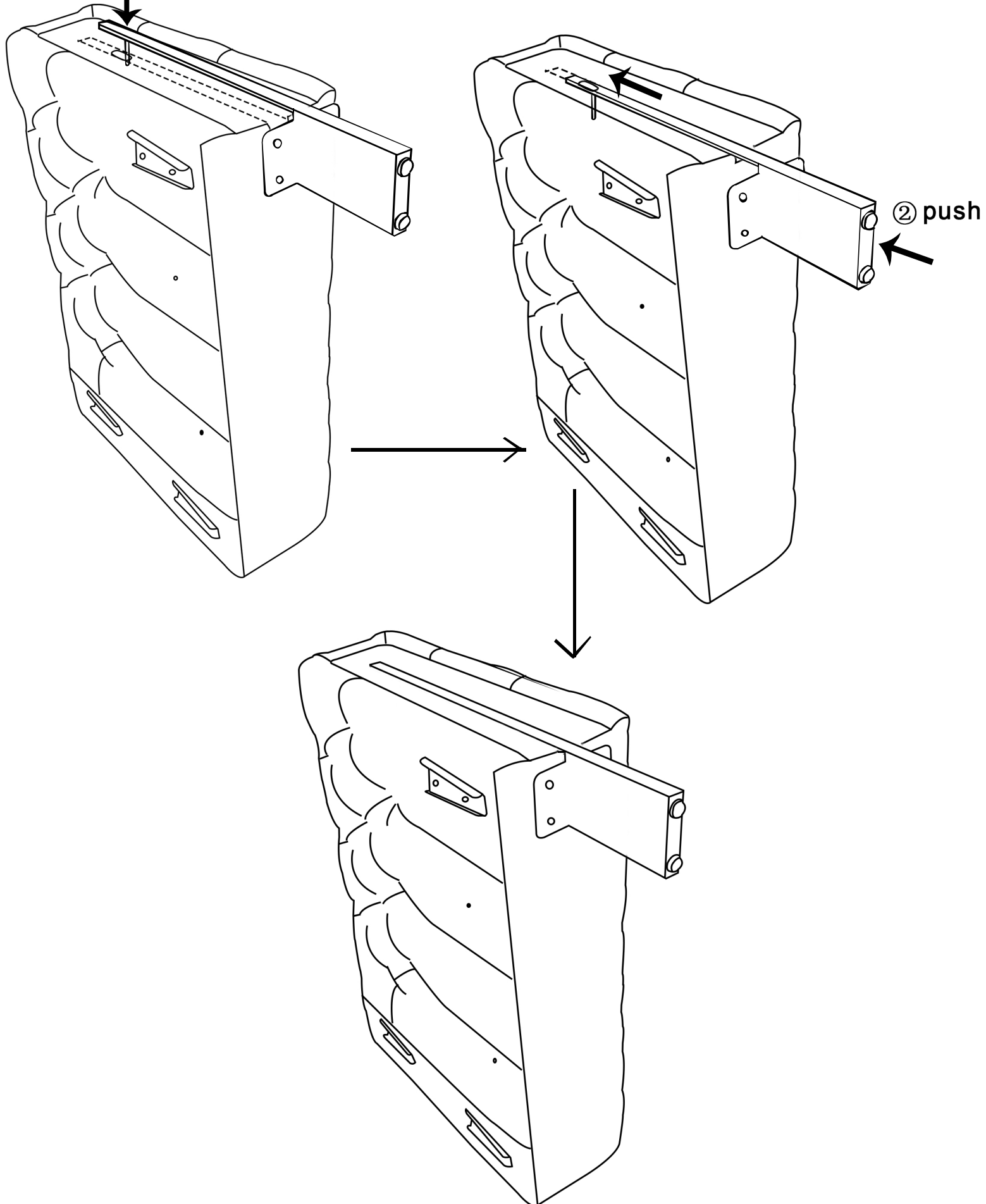



**Step 4 Assemble the center bar.**

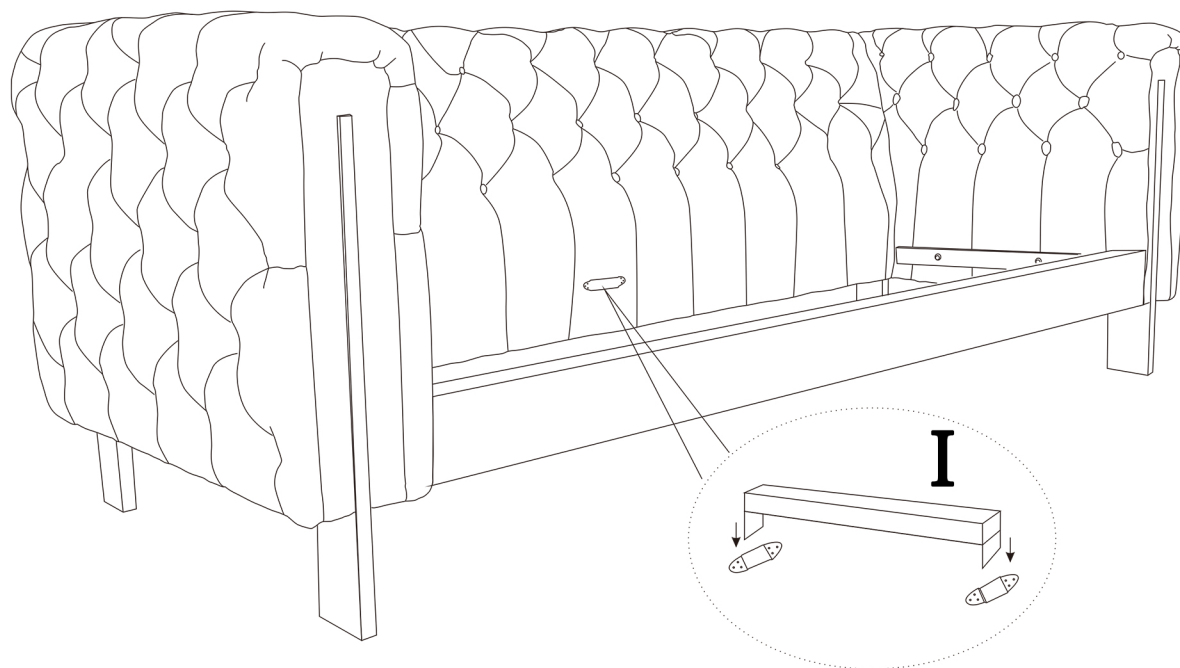

**Step 5**

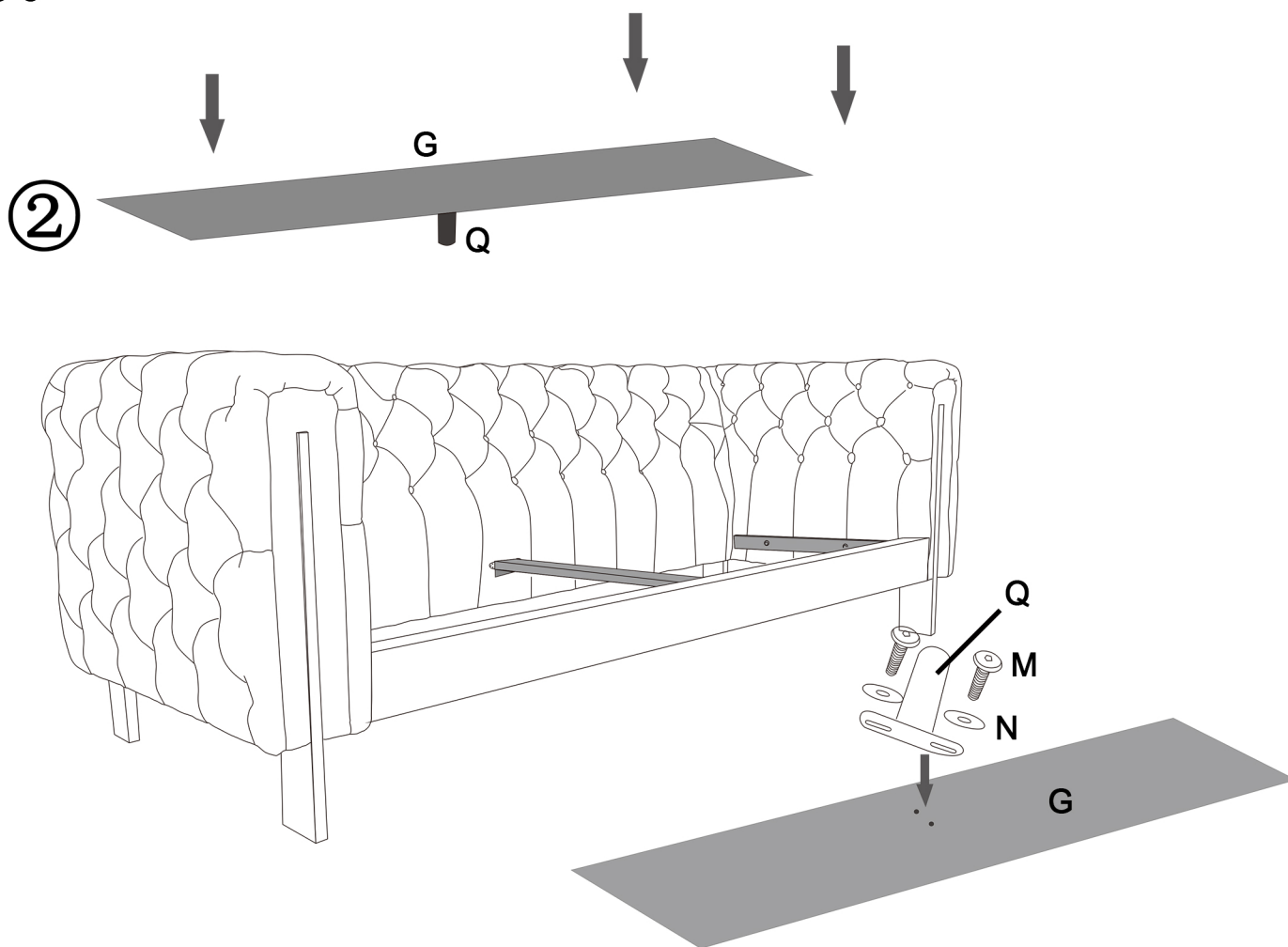

**① Assemble the middle leg in the middle of the bottom board first.**

**Step 6 Assemble the seat cushions, then put on the bottom board.**

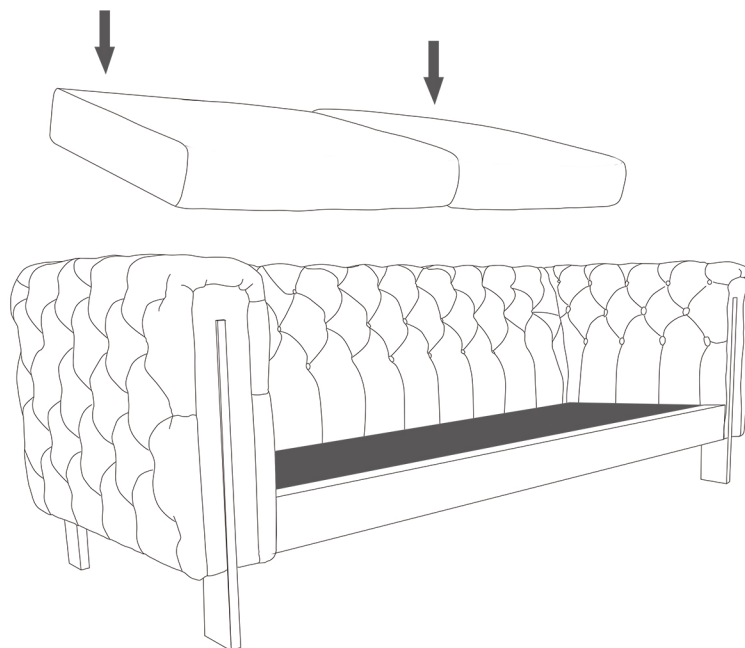

**Step 7**

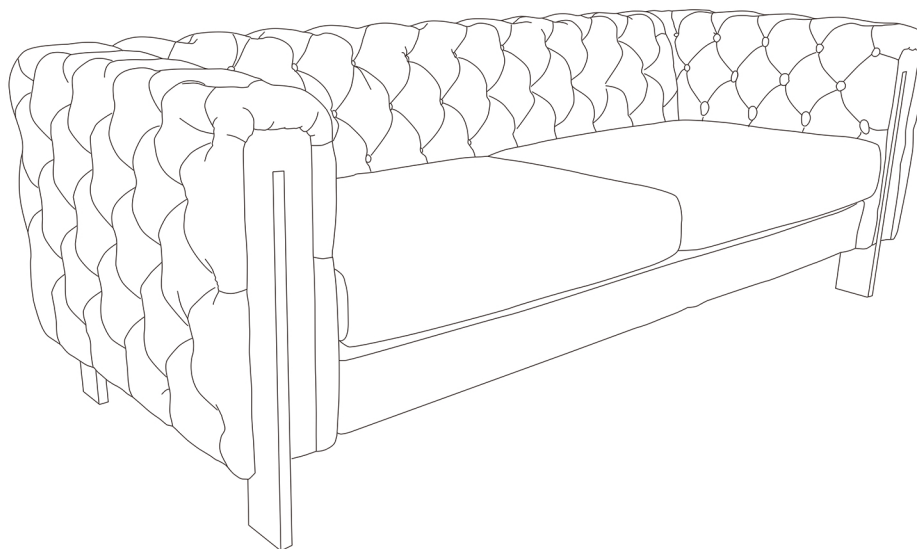

**Step 8**

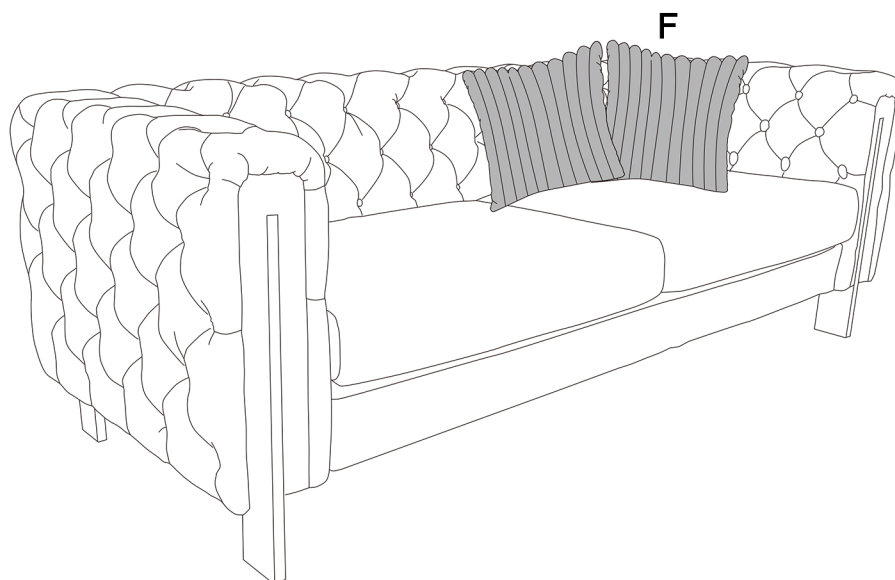

## How to install the cushions

Step 1. Open the plastic bag and remove the cushions foam wrapped with polyester fiber&Non-woven bags from the plastic bag.

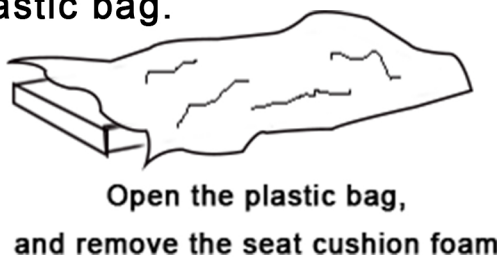
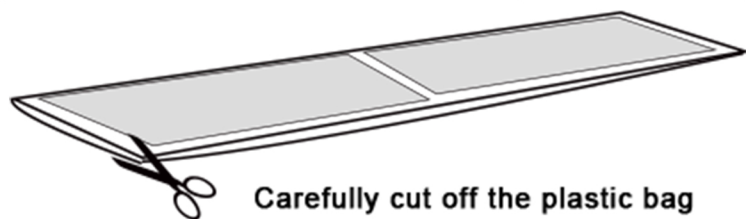

Step 2. Cover the fabric covers to all seat cushions. **PLEASE DON'T REMOVE THE NON-WOVEN BAG & POLYESTER FIBER OF THE SEAT CUSHIONS, PLEASE KEEP IT AS IT IS.** When you get the seat cushion, you will see the RED words which side is the **Top**, **Front** and **Back** as following.

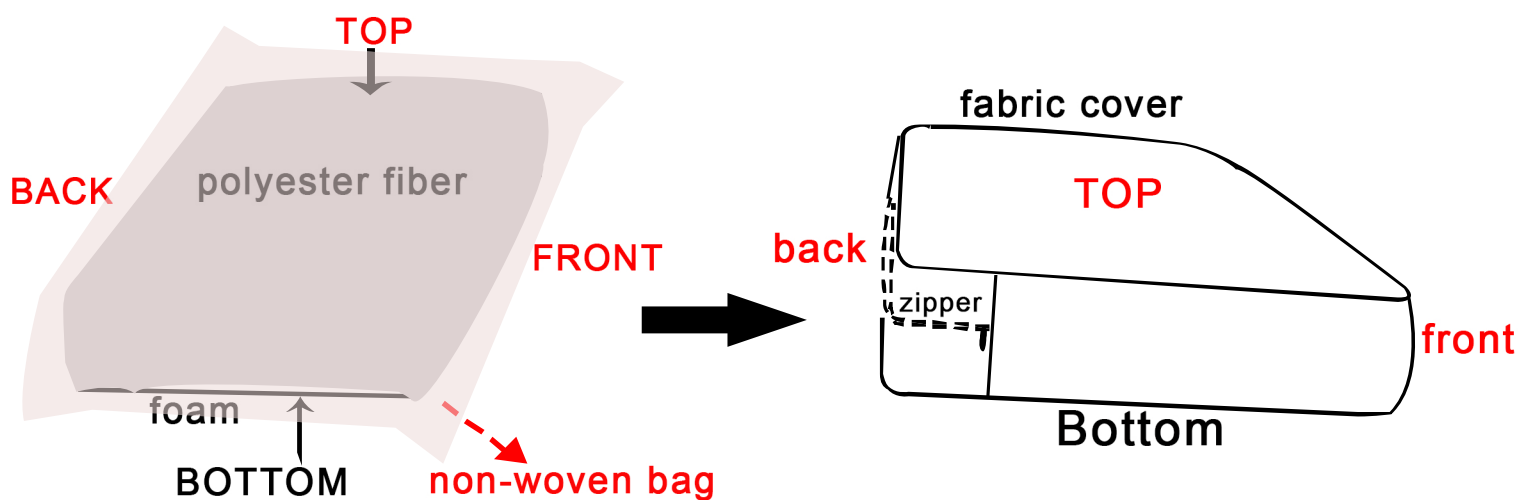

## How to tidy sofa seat cushion?



**TIPS**

At the beginning all cushions are a little loose which is normal. Please allow at least 72 hours for all cushions foam to recover to its natural state after covering the fabric covers.