

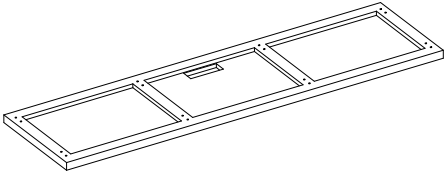

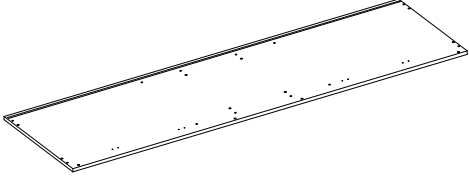

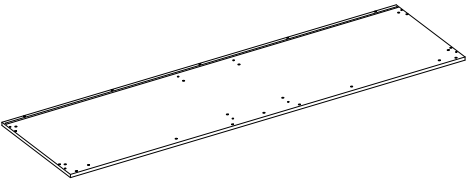

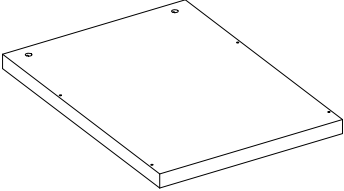

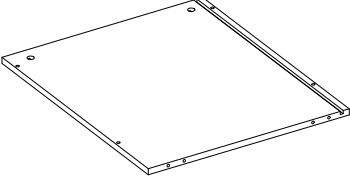
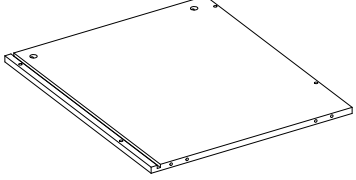
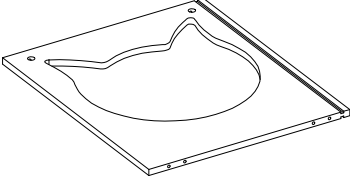
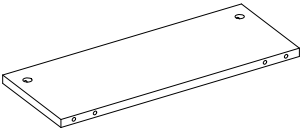
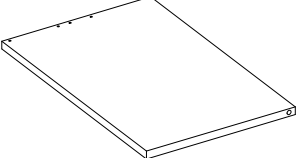
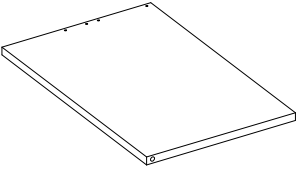
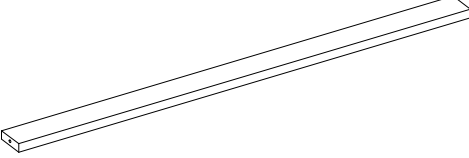
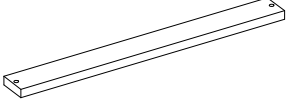
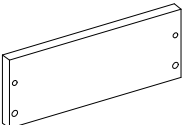
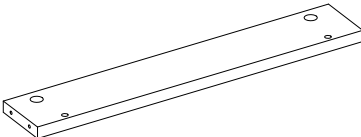
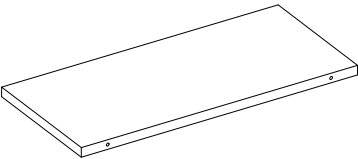
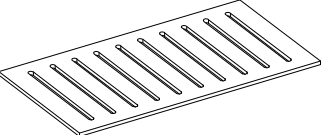
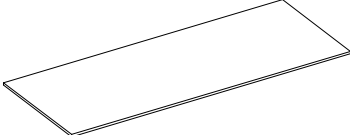
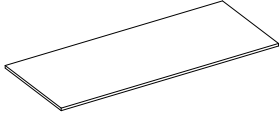
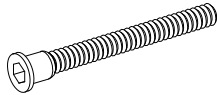

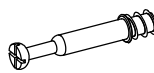

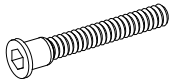
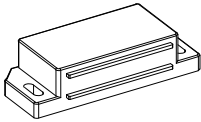

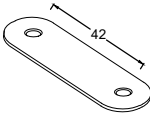

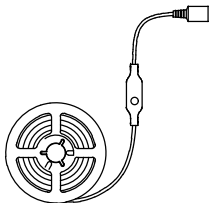
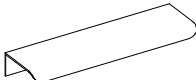

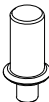
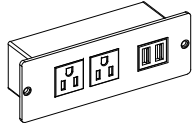

<p>① x1</p> 	<p>② x1</p> 	<p>③ x1</p> 
<p>④ x2</p> 	<p>⑤ x1</p> 	<p>⑥ x1</p> 
<p>⑦ x2</p> 	<p>⑧ x2</p> 	<p>⑨ x2</p> 
<p>⑩ x2</p> 	<p>⑪ x2</p> 	<p>⑫ x2</p> 
<p>⑬ x2</p> 	<p>⑭ x2</p> 	<p>⑮ x1</p> 
<p>⑯ x1</p> 	<p>⑰ x4</p> 	<p>⑱ x1</p> 

<p>(A) x34+4</p>  <p>Ø5x40</p>	<p>(B) x32+3</p>  <p>Ø6x35</p>	<p>(C) x20+2</p>   <p>Ø6*35 Ø12</p>
<p>(D) x8+1</p>  <p>Ø5x30</p>	<p>(E) x4</p>   <p>Ø3.0*14</p>	<p>(F) x4</p>   <p>42 Ø3.0*12</p>
<p>(G) x1</p> 	<p>(H) x4</p>   <p>Ø3.0*12</p>	<p>(I) x12</p>   <p>Ø3.0*14</p>
<p>(J) x4</p> 	<p>(K) x4</p> 	<p>(L) x1</p>   <p>M4*10</p>
<p>(M) x1</p>   <p>Ø3.5x12</p>	<p>TOOL</p>  <p>3mm</p> 	

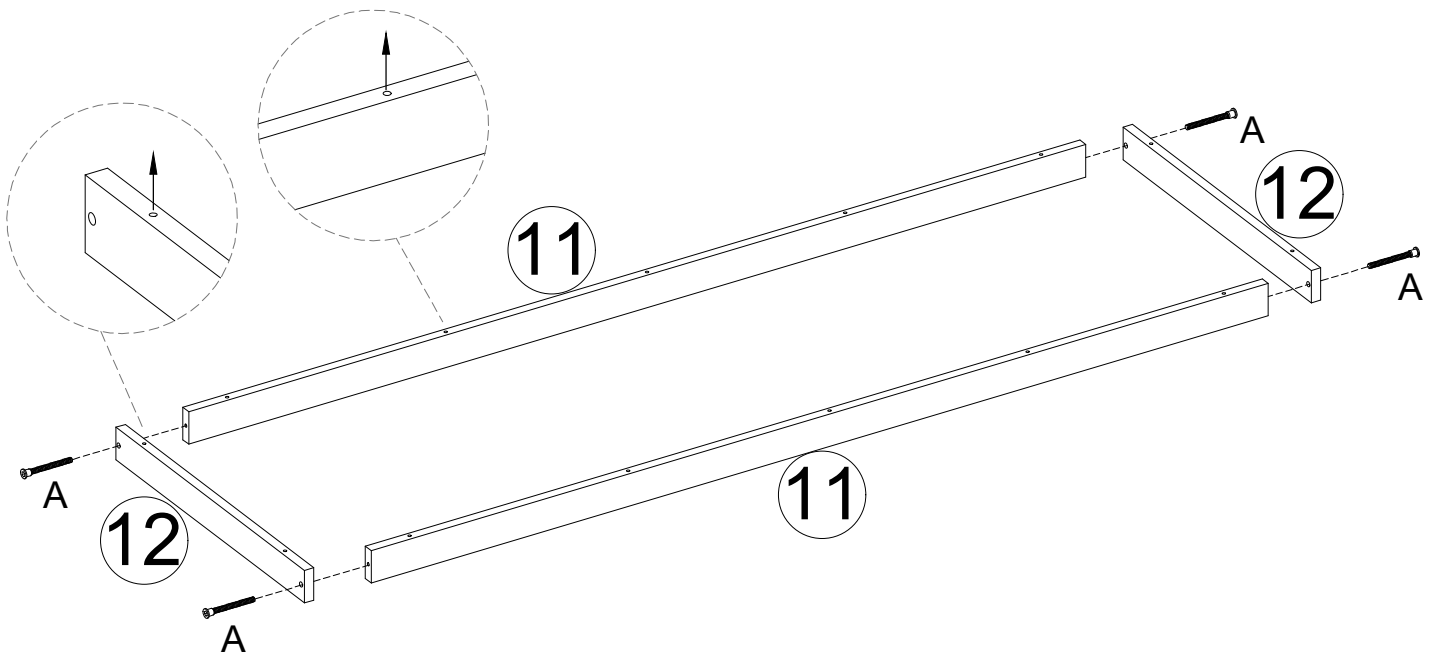

STEP 1

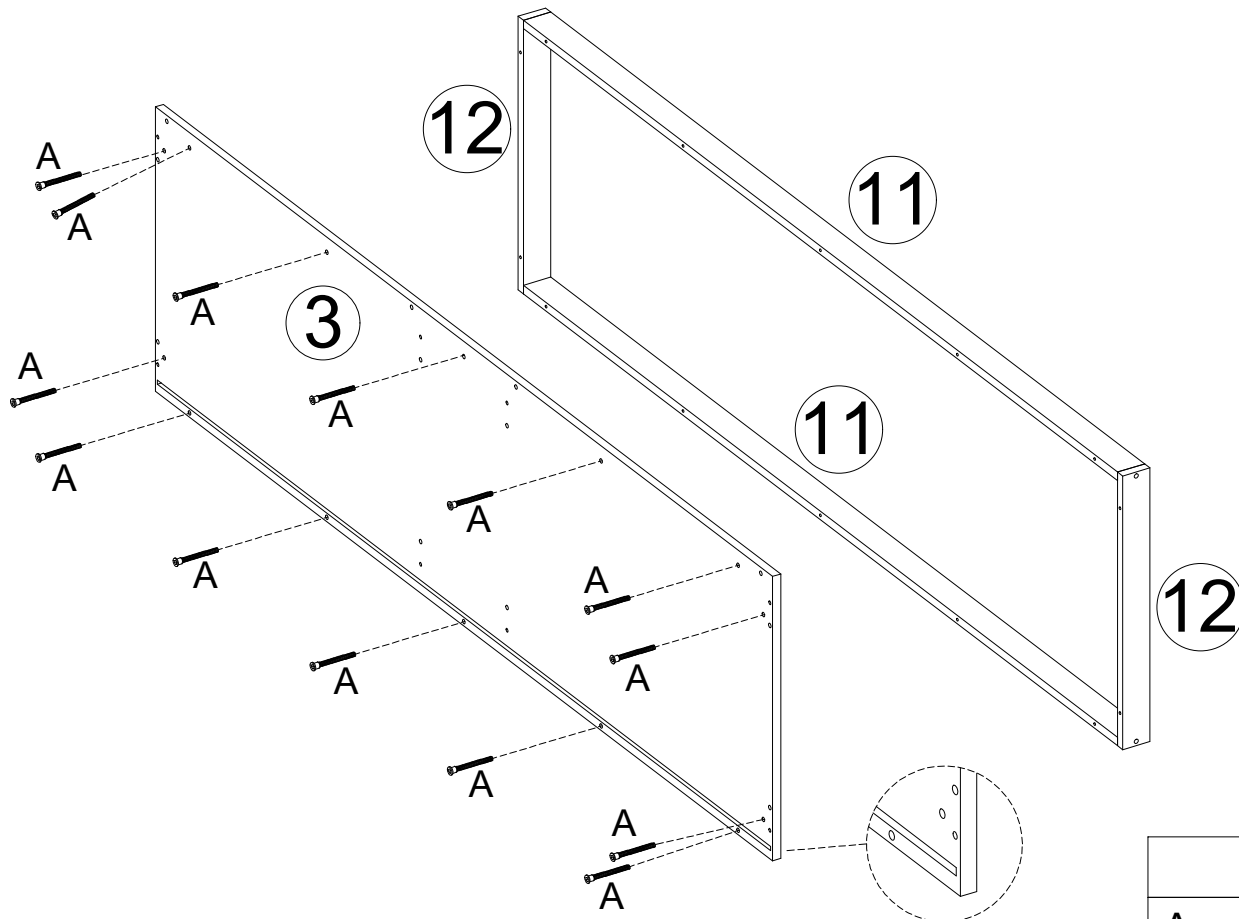

		3mm
A		x4

STEP 2



		3mm
A		x14

STEP 3

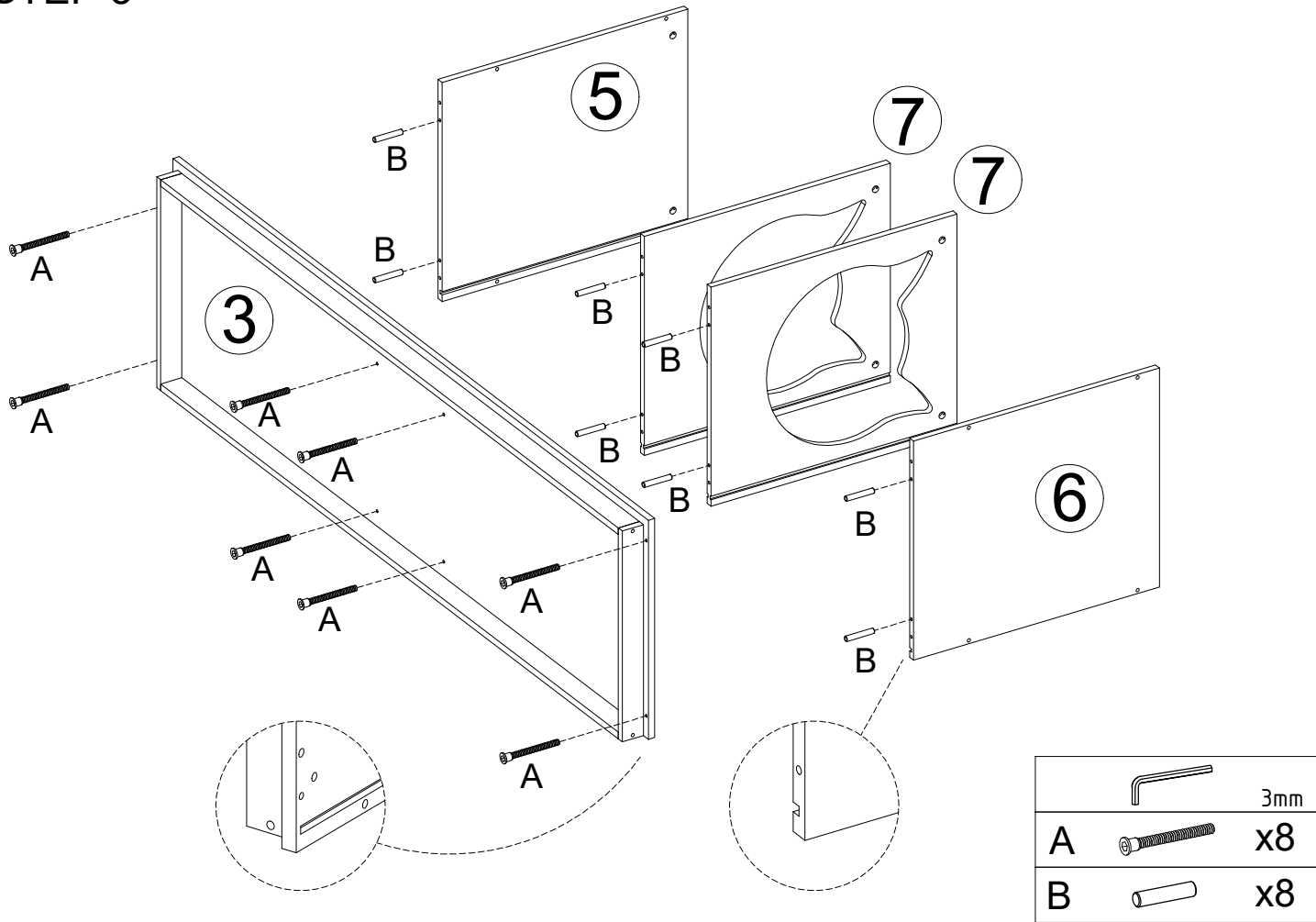

STEP 4

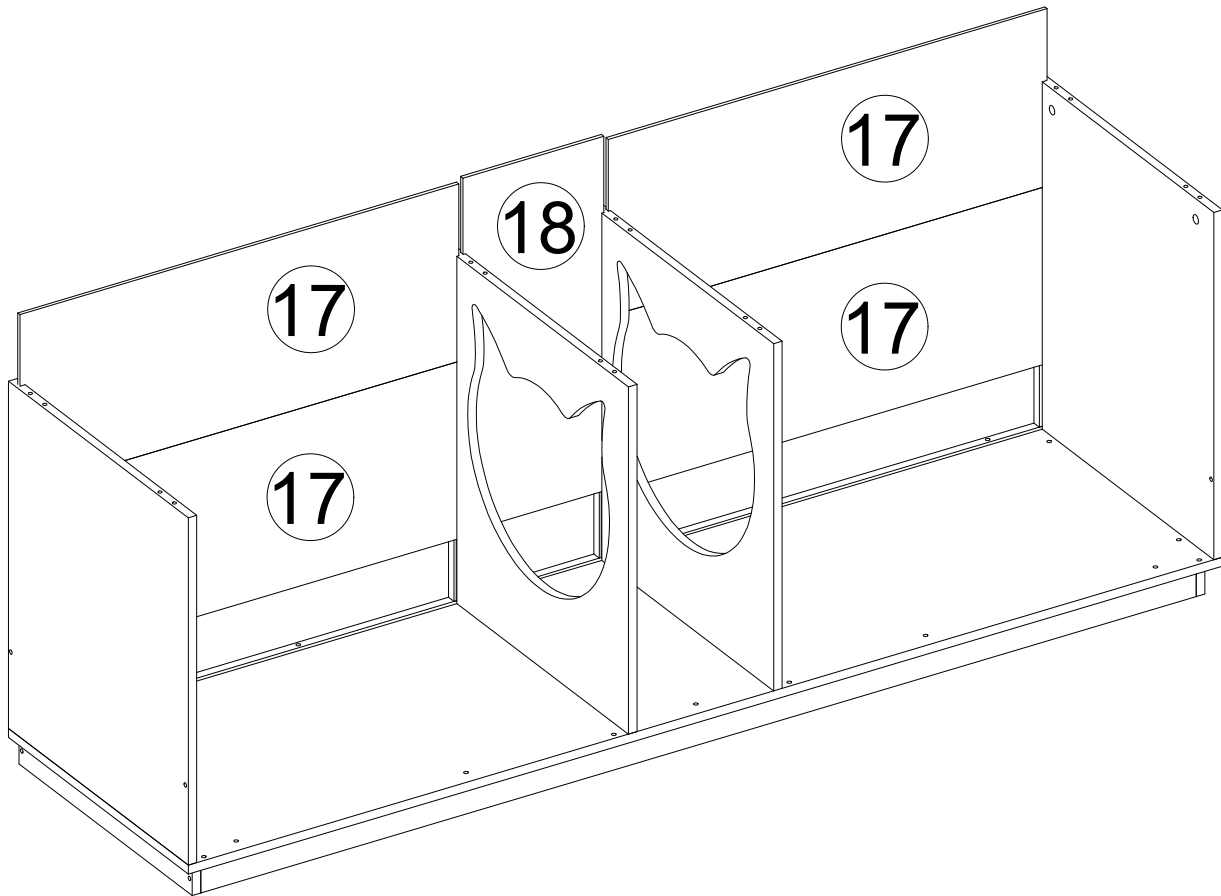

STEP 5

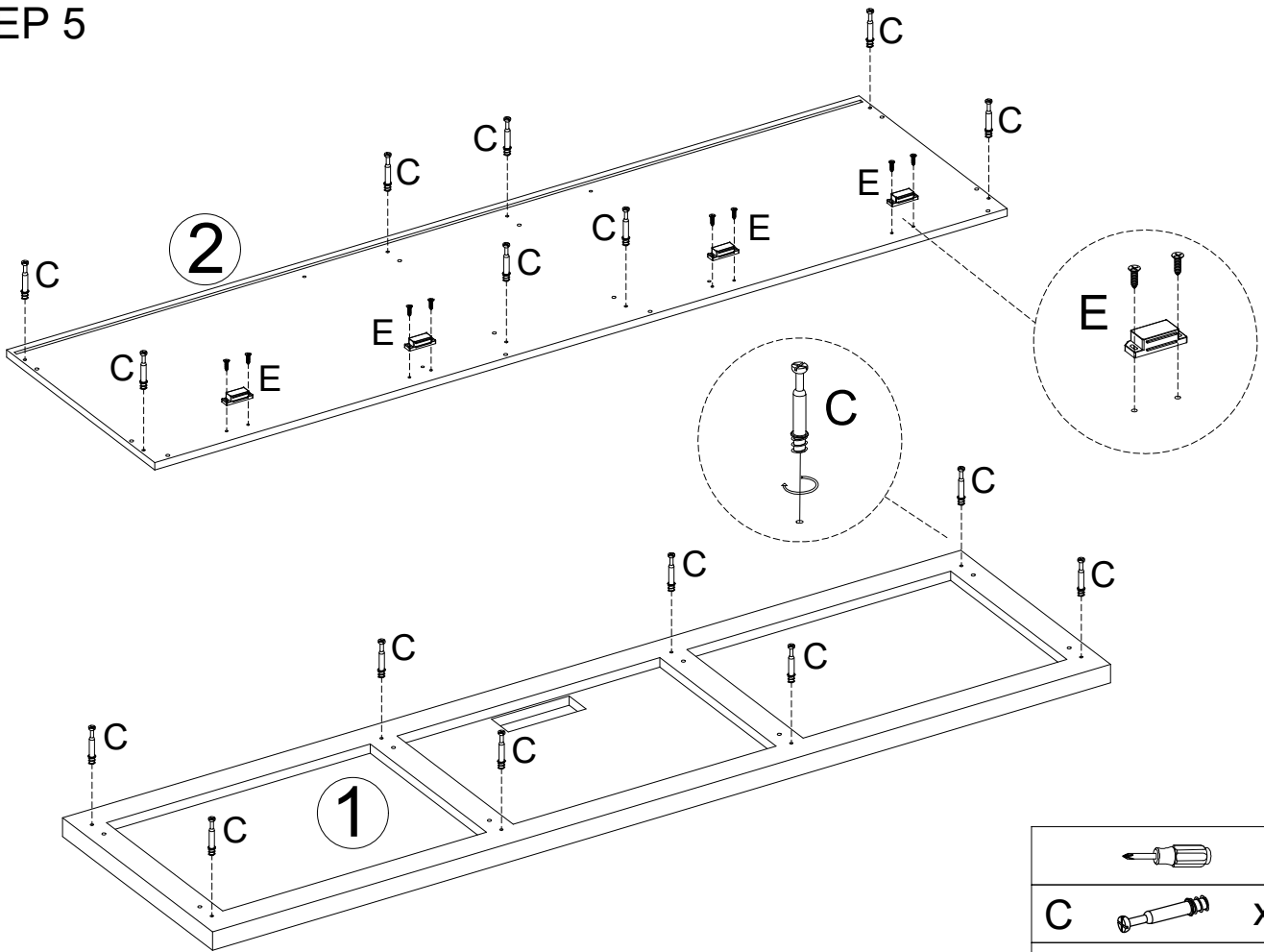

C		x16
E		x4

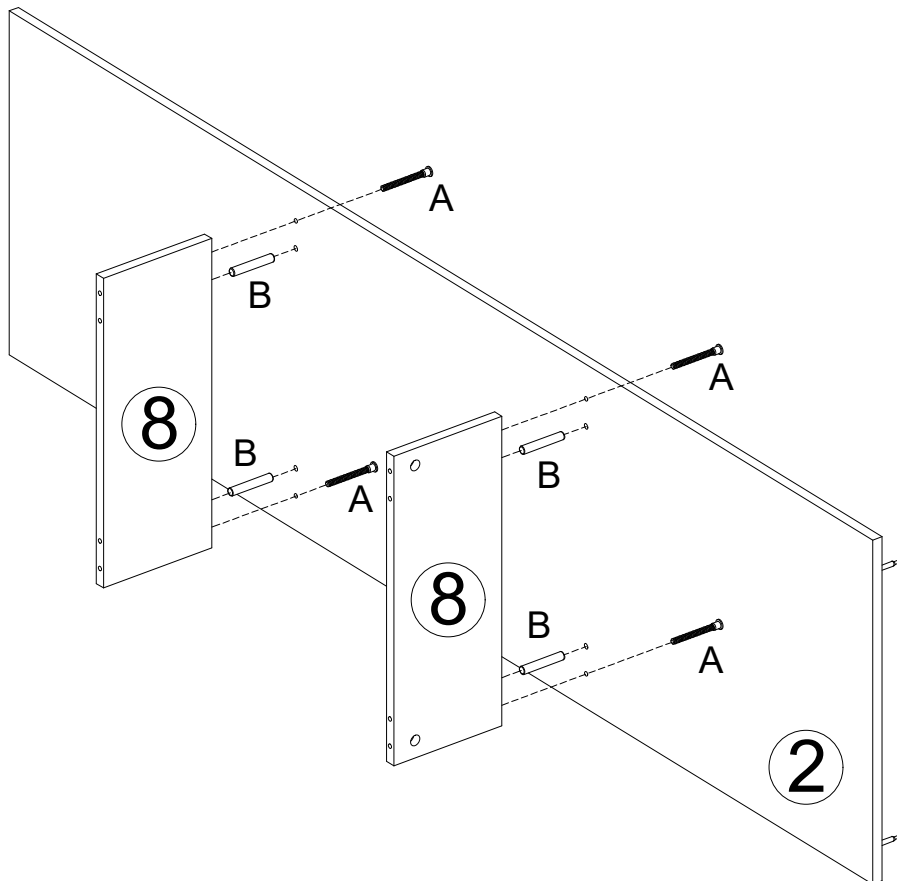

STEP 6

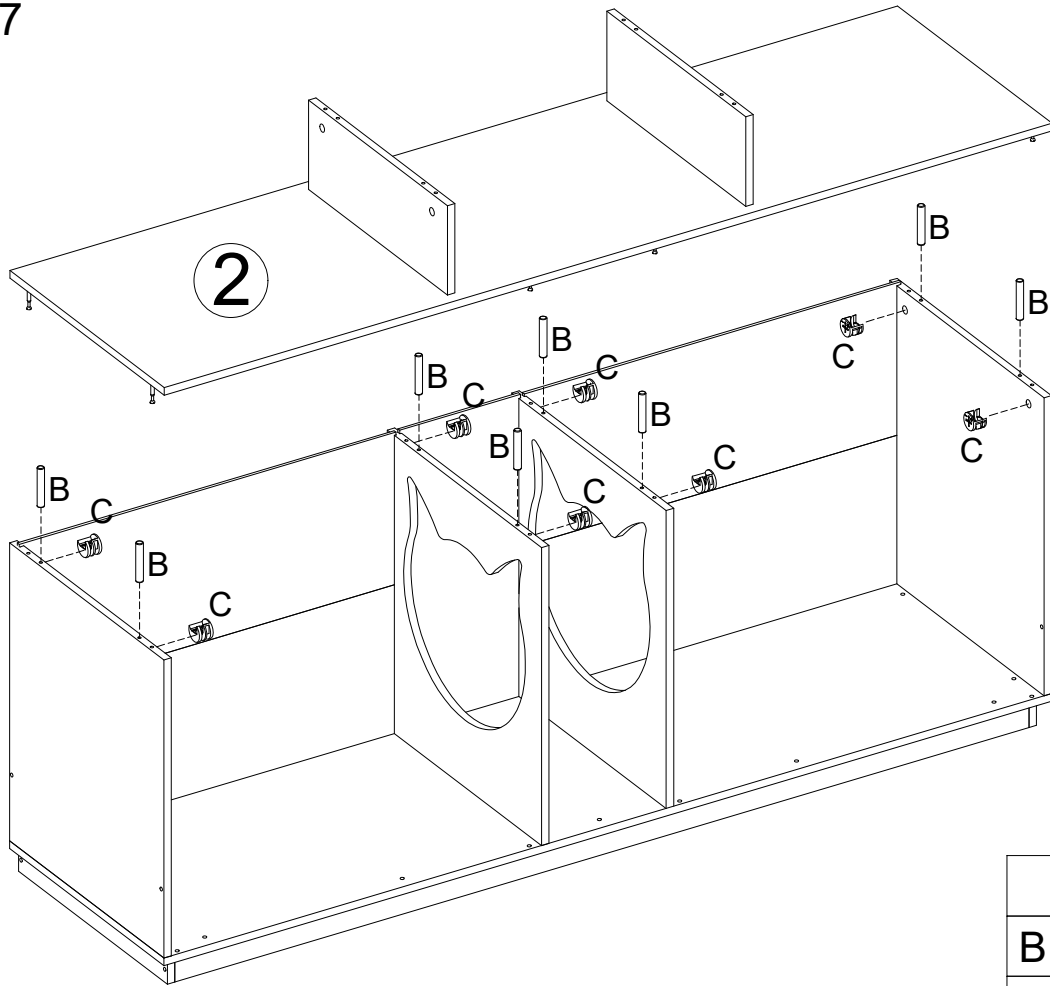

		3mm
A		x4
B		x4

STEP 7



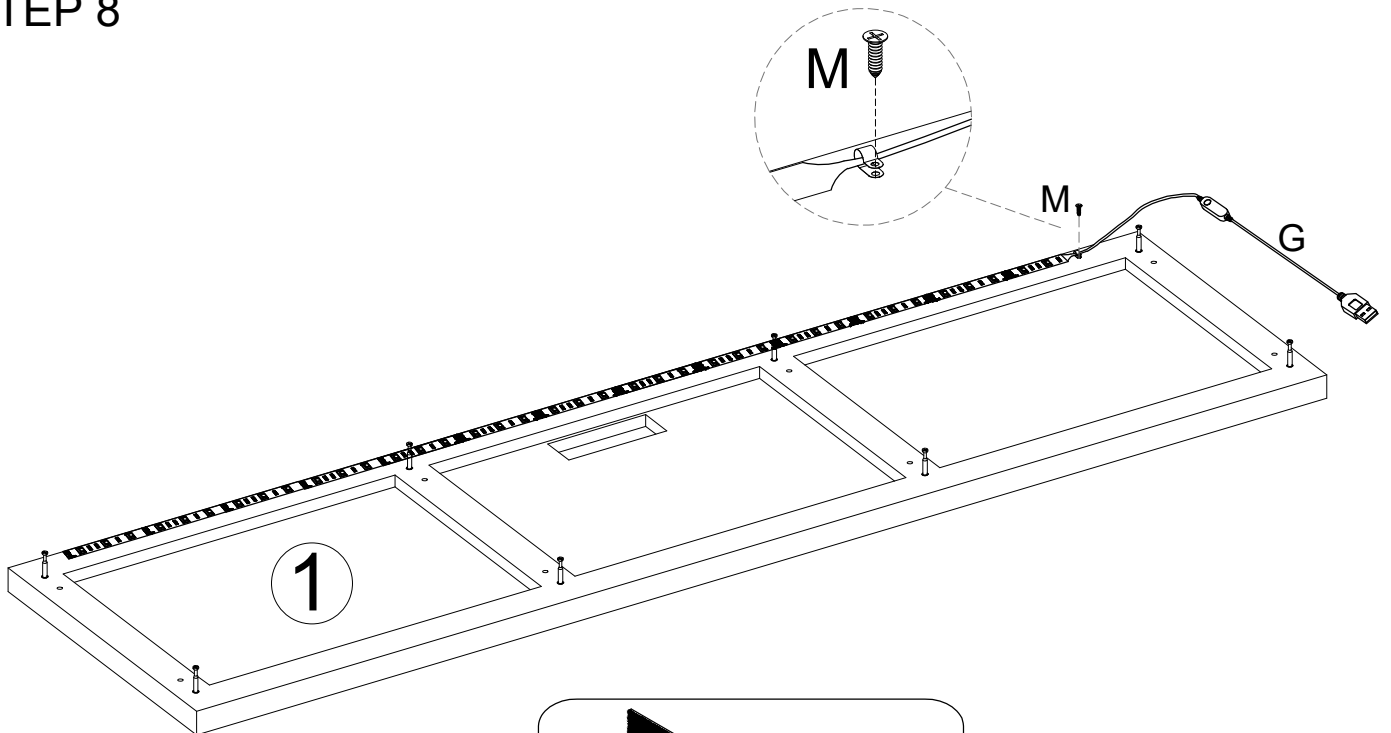
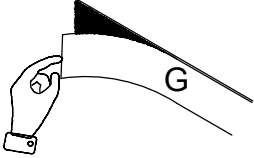

		
B		x8
C		x8

STEP 8





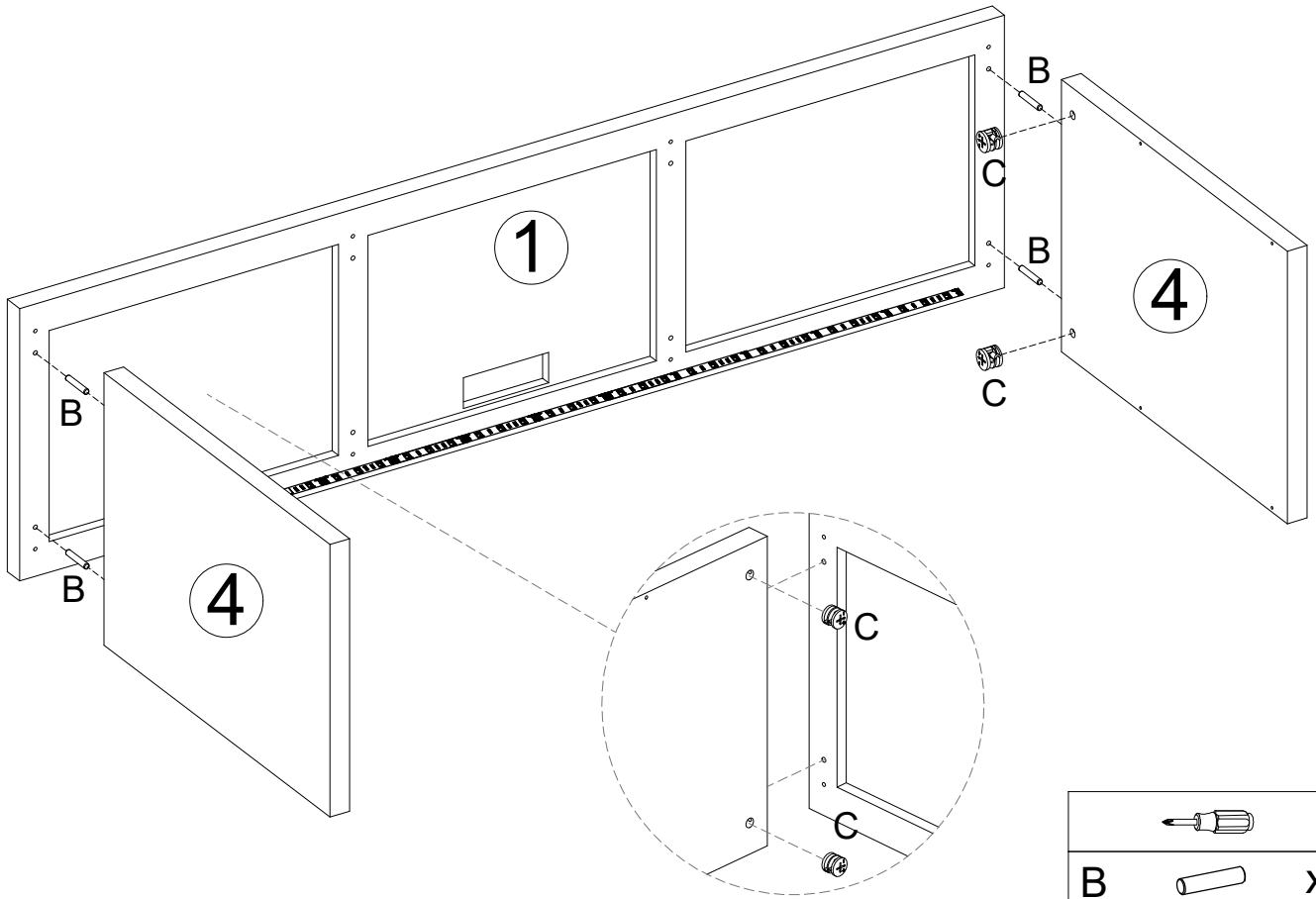

Tear off the tape and apply it to the bottom plate, then press it firmly with your hand

		
M		x1
G		x1



STEP 9



		
B		x4
C		x4

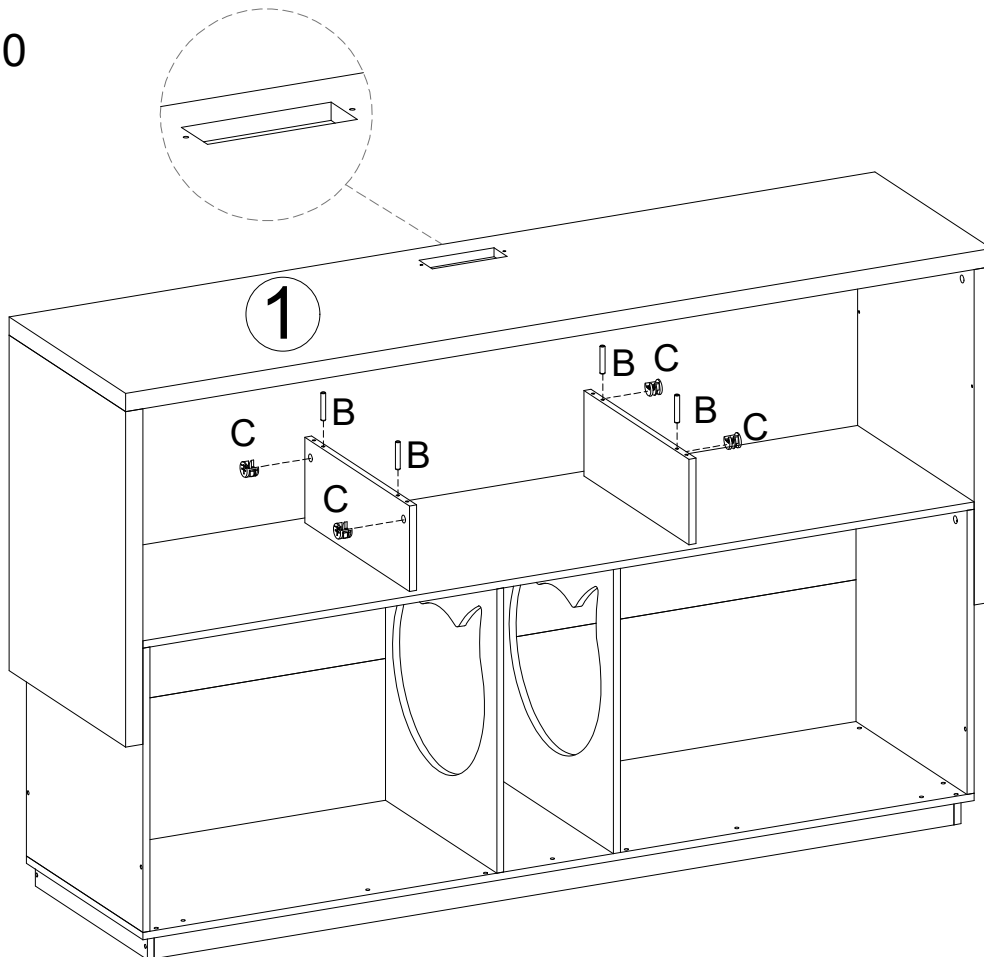

STEP 10



		
B		x4
C		x4

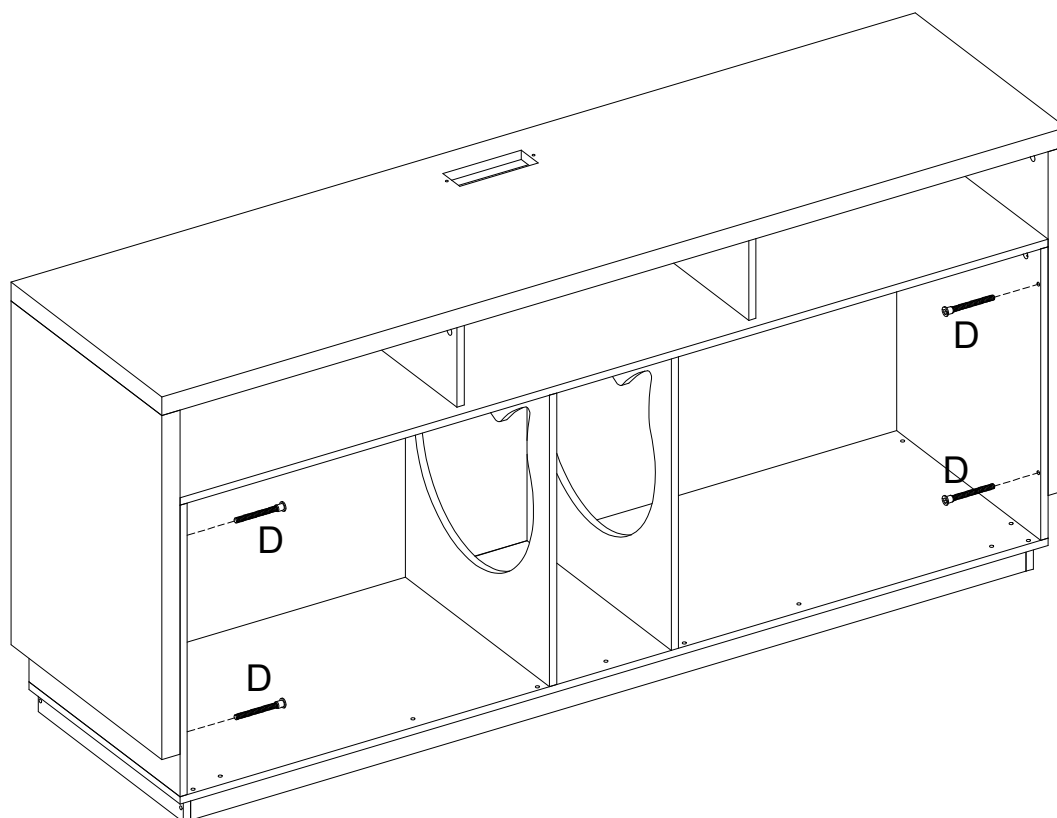



STEP 11

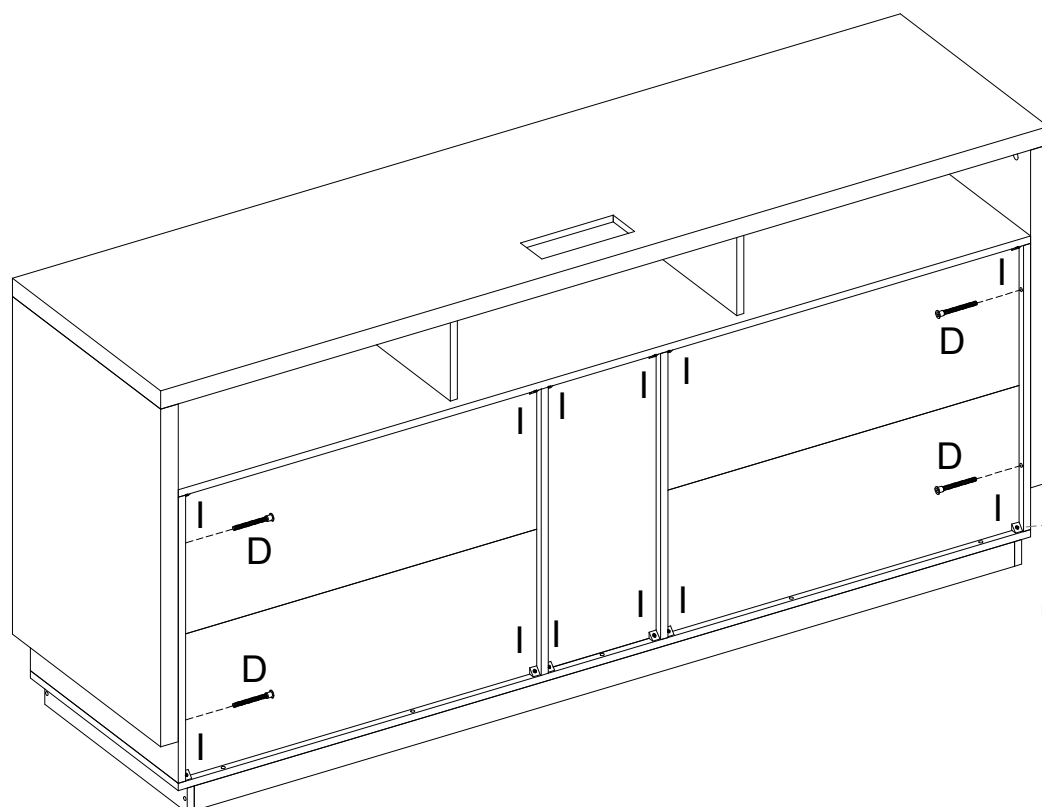

		3mm
D		x4

STEP 12



			3mm
D			x4
I			x12

STEP 13

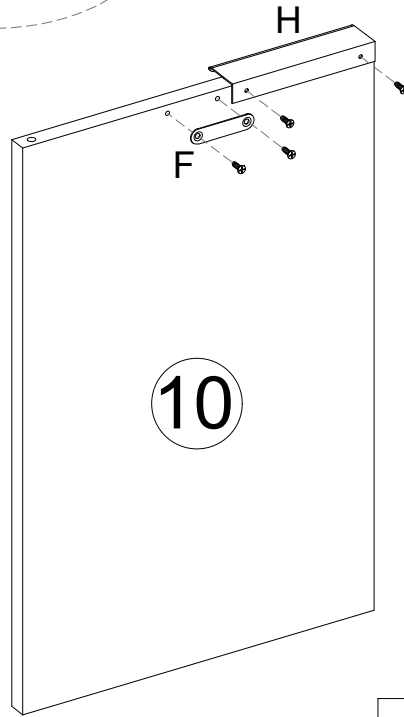
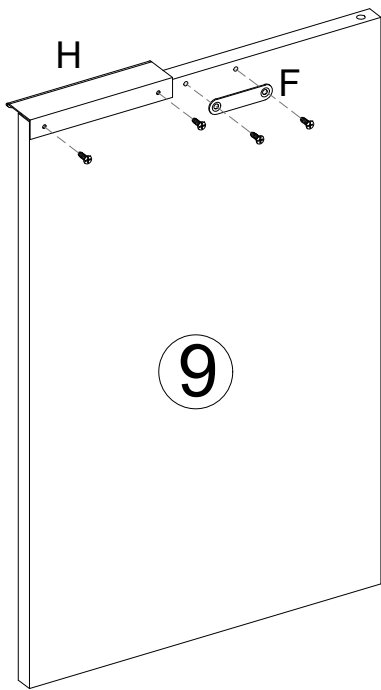
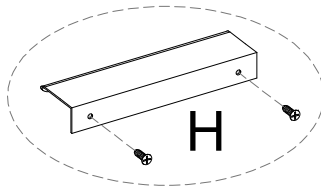
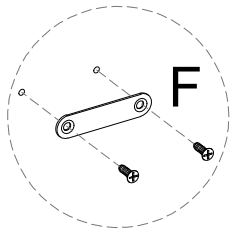

x2

F		⌘	x4
H		⌘	x4

STEP 14

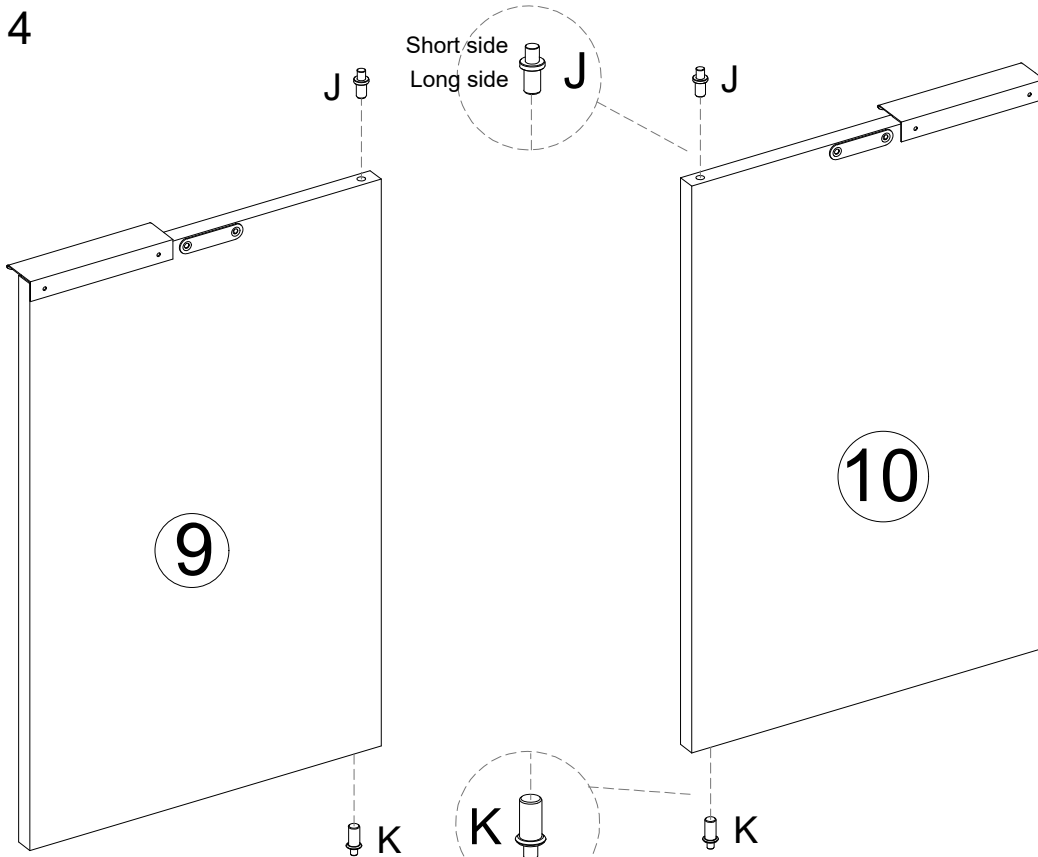

x2

You need to hammer it in when installing J.
Don't hammer it in when installing K.
Large hole to install K, small hole to install J

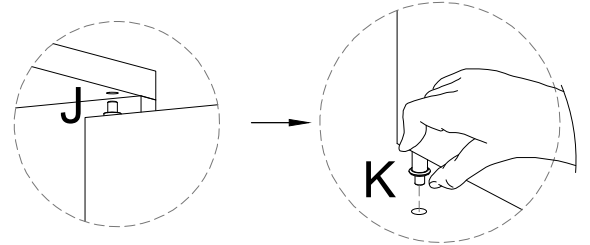
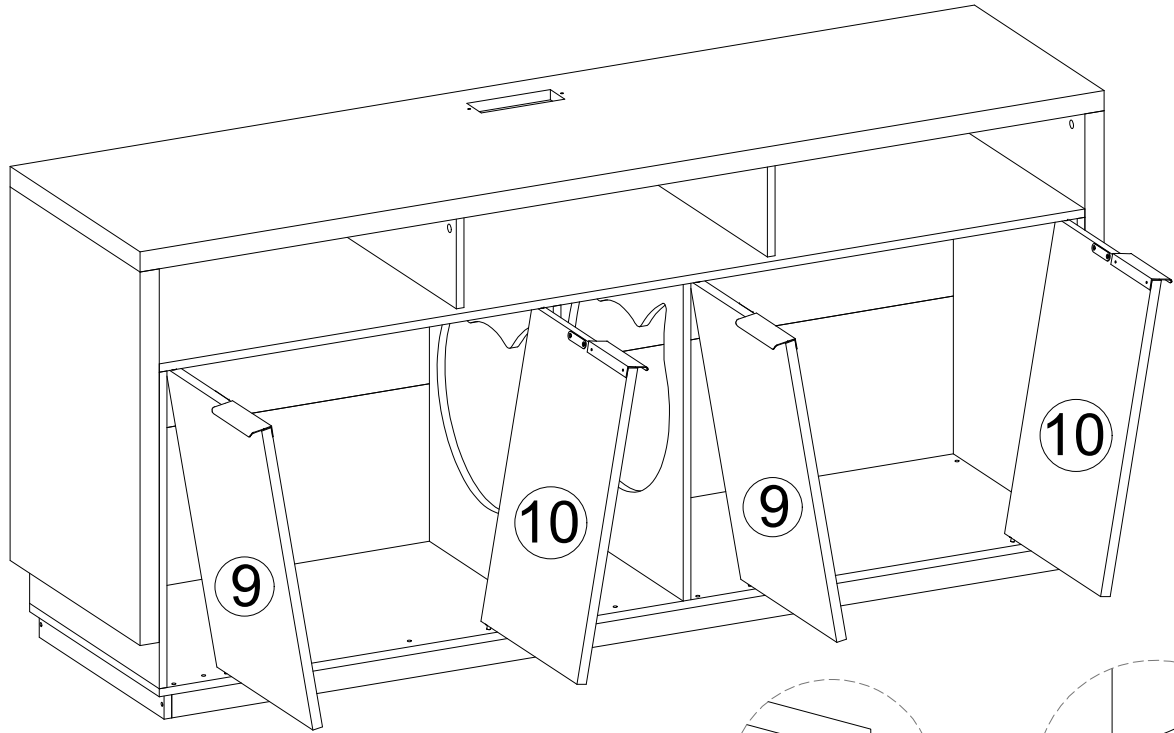

J		⌘	x4
K		⌘	x4

STEP 15

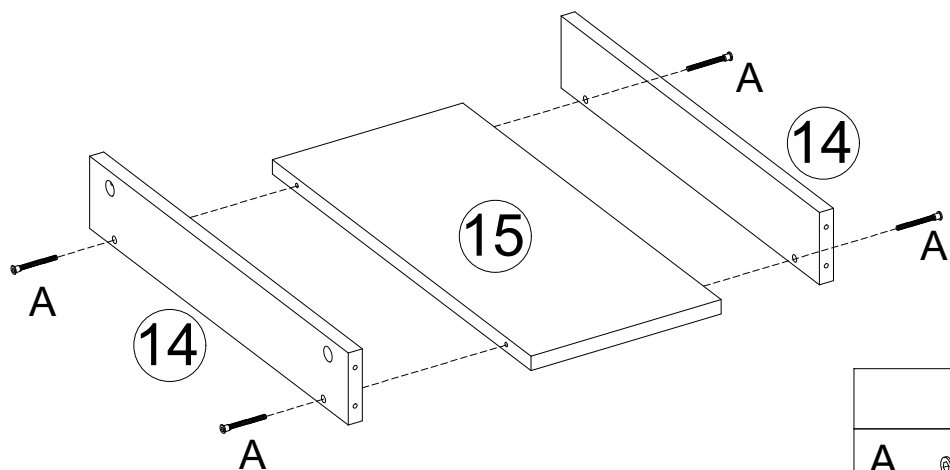
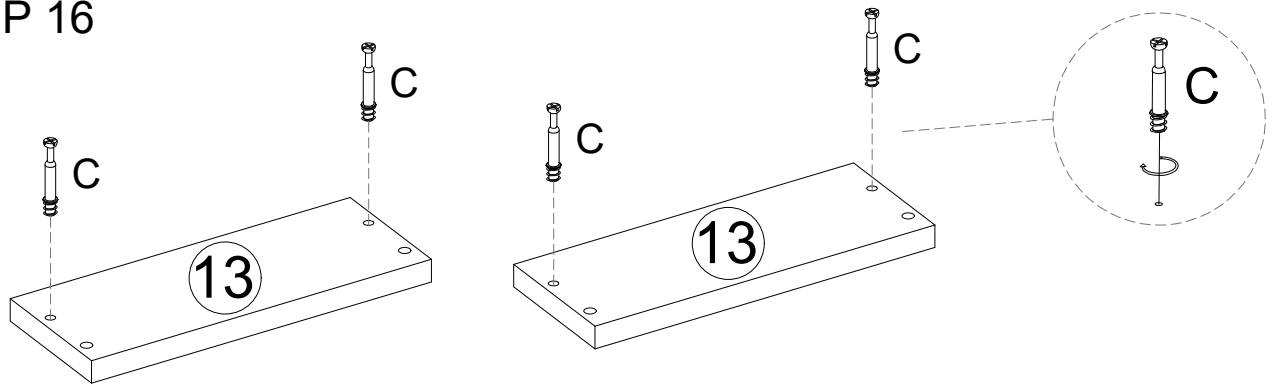

STEP 16



		3mm
A		x4
C		x4

STEP 17

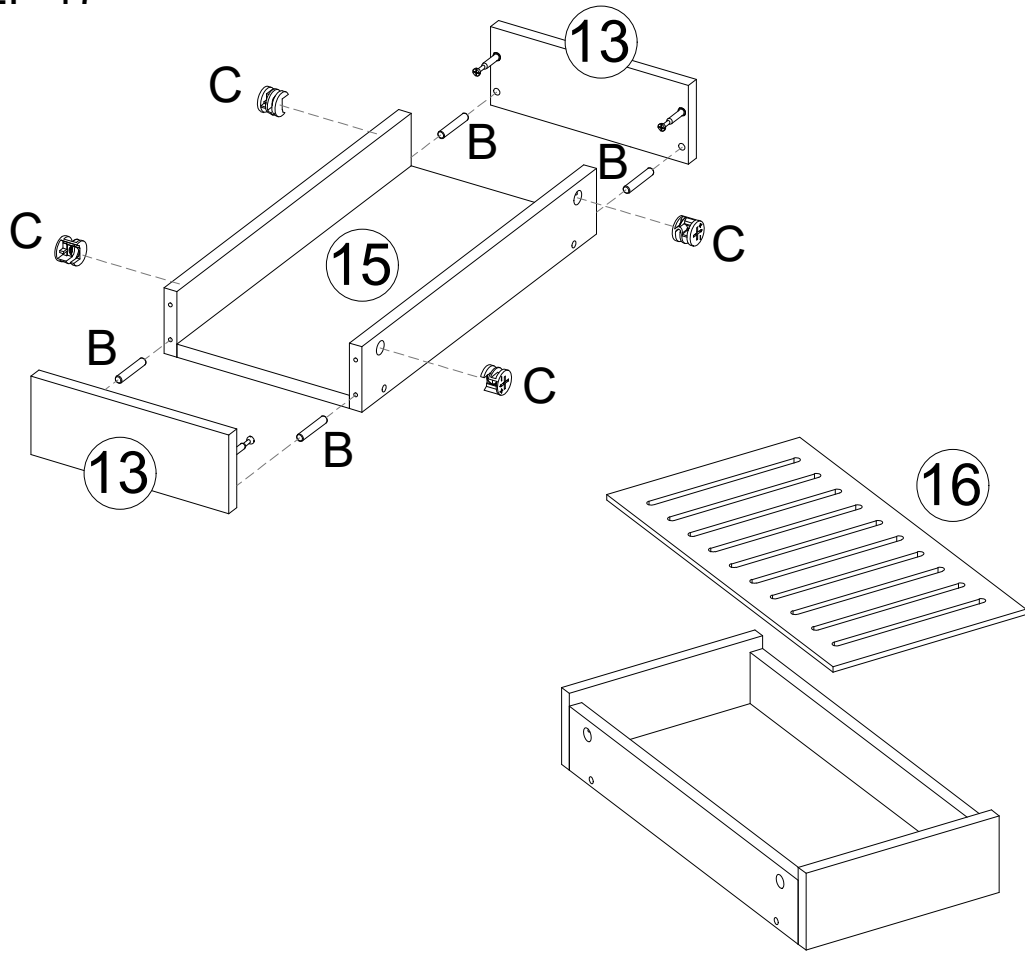

B		x4
C		x4

STEP 18

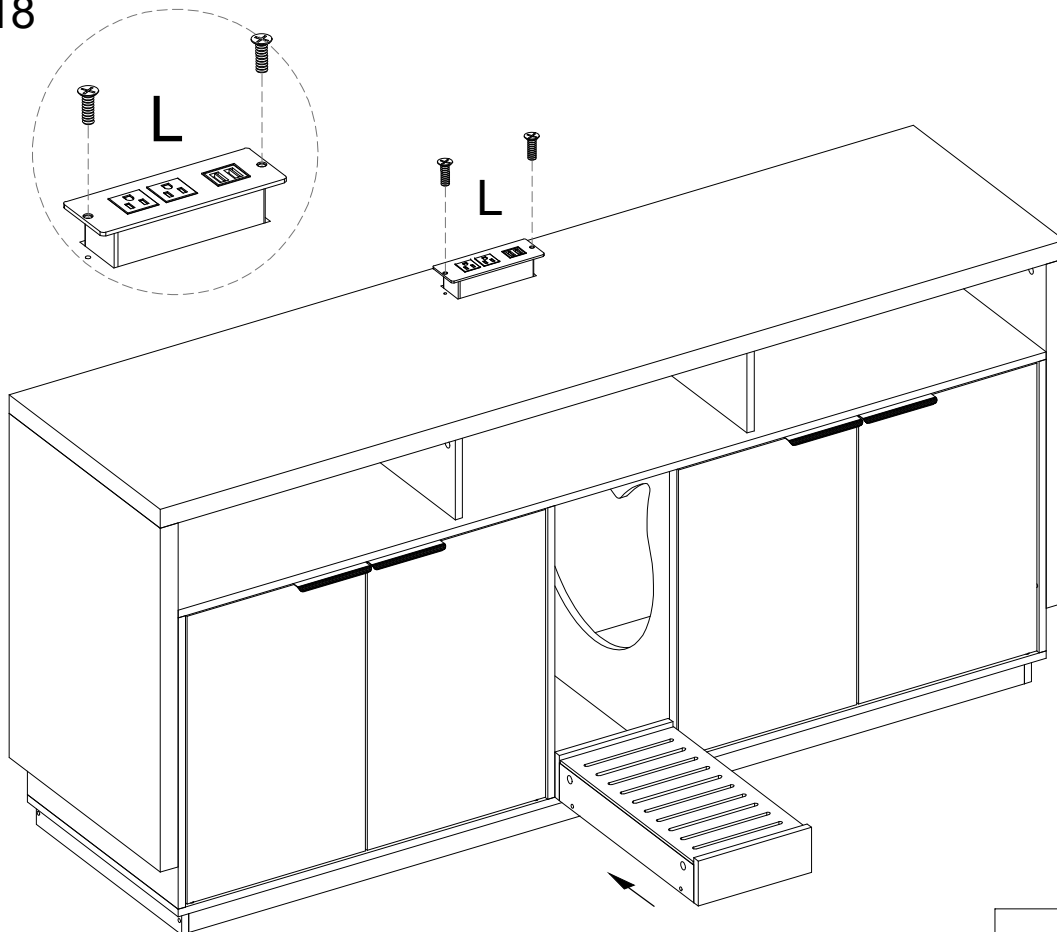

L		x1

STEP 19

