



**INSTRUCTIONS D'ASSEMBLAGE
ASSEMBLY INSTRUCTIONS**

**TABLE D'APPOINT -
32"H / TAUPE FONCE**

**ACCENT TABLE -
32"H / DARK TAUPE**



**POUR DE L'ASSISTANCE OU POUR COMMANDER
DES PIÈCES CONTACTEZ NOTRE DÉPARTEMENT
DE SERVICE À LA CLIENTÈLE.**

**FOR ASSISTANCE OR TO ORDER PARTS
CONTACT OUR CUSTOMER SERVICE DEPARTMENT**

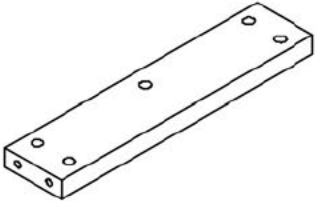
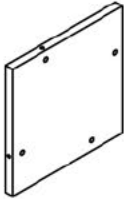
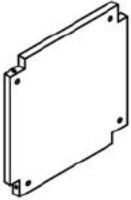
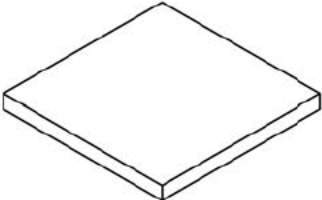

LISTE DES PIÈCES PARTS LIST

PIÈCE / PART #	IMAGE	DESCRIPTION	QTY / QTÉ
1		LEG PATTE	4
2		CROSSBAR BARRE TRANSVERSALE	4
3		SHELF PANEL PANNEAU DE TABLETTE	1
4		BOTTOM SHELF ÉTAGÈRE DU BAS	1
5		TABLE TOP SURFACE DE TABLE	1

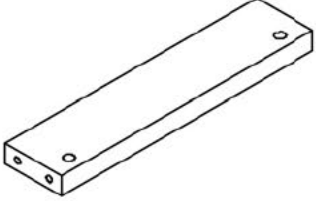

LISTE DES PIÈCES
PARTS LIST

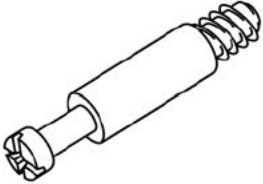
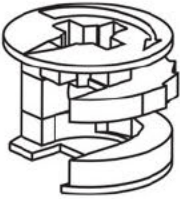
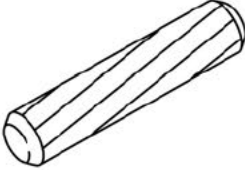
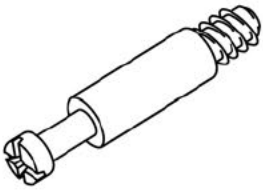
PIÈCE / PART #	IMAGE	DESCRIPTION	QTY / QTÉ
6		CROSSBAR BARRE TRANSVERSALE	4

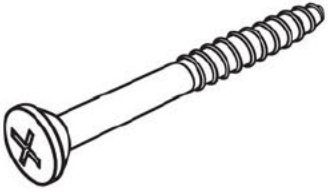
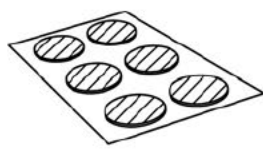

LISTE DES PIÈCES DE MONTAGE HARDWARE LIST

PIÈCE / PART #	IMAGE	DESCRIPTION	QTY / QTÉ
A		CAM LOCK SCREW - 1 1/8" VIS CAM LOCK - 1 1/8"	16
B		CAM LOCK CONNECTOR - Ø5/8" ÉCROU CAM LOCK - Ø5/8"	16
C		WOOD DOWEL - Ø3/8" X 1" GOUJON DE BOIS - Ø3/8" X 1"	8
D		CAM LOCK SCREW - 1" VIS CAM LOCK - 1"	16
E		CAM LOCK CONNECTOR - Ø1/2" ÉCROU CAM LOCK - Ø1/2"	16

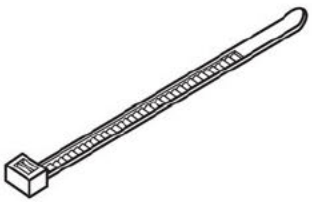
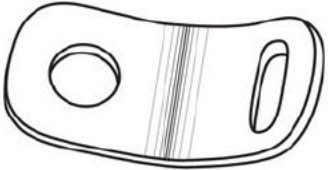
LISTE DES PIÈCES DE MONTAGE HARDWARE LIST

PIÈCE / PART #	IMAGE	DESCRIPTION	QTY / QTÉ
F		<p>ASSEMBLING SCREW - Ø1/8" X 2 3/8"</p> <p>VIS D'ASSEMBLAGE - Ø1/8" X 2 3/8"</p>	4
G		<p>FINISHING STICKER - Ø1/2"</p> <p>COLLANT DE FINITION - Ø1/2"</p>	4
H		<p>FLOOR PROTECTOR - Ø5/8"</p> <p>PROTECTEUR DE PLANCHER - Ø5/8"</p>	4
I		<p>ZIP TIE - 7 3/4" X 1/8"</p> <p>ATTACHE AUTOBLOQUANTE - 7 3/4" X 1/8"</p>	1
J		<p>METAL BRACKET - 1/2" X 1/2"</p> <p>SUPPORT DE MÉTAL - 1/2" X 1/2"</p>	2

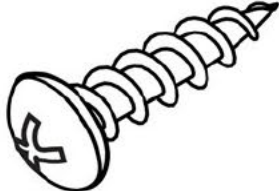
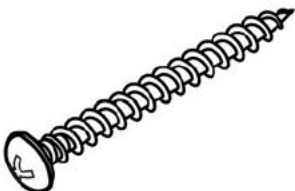
LISTE DES PIÈCES DE MONTAGE
HARDWARE LIST

PIÈCE / PART #	IMAGE	DESCRIPTION	QTY / QTÉ
K		ASSEMBLING SCREW - Ø1/8" X 1" VIS D'ASSEMBLAGE - Ø1/8" X 1"	1
L		ASSEMBLING SCREW - Ø1/8" X 1 1/2" VIS D'ASSEMBLAGE - Ø1/8" X 1 1/2"	1
M		ANCHOR - Ø3/8" X 1 1/2" ANCRE - Ø3/8" X 1 1/2"	1
N		GLUE COLLE	1

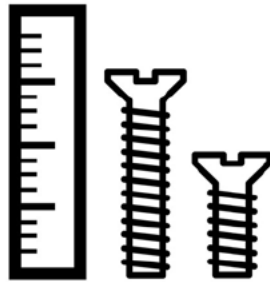

**OUTIL DE VÉRIFICATION DE DIMENSIONS DES PIÈCES
HARDWARE DIMENSIONS VERIFICATION TOOL**

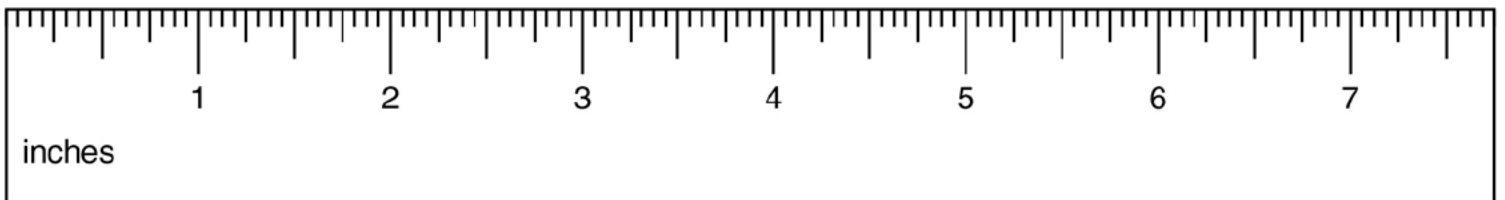

ÉTAPE / STEP 1

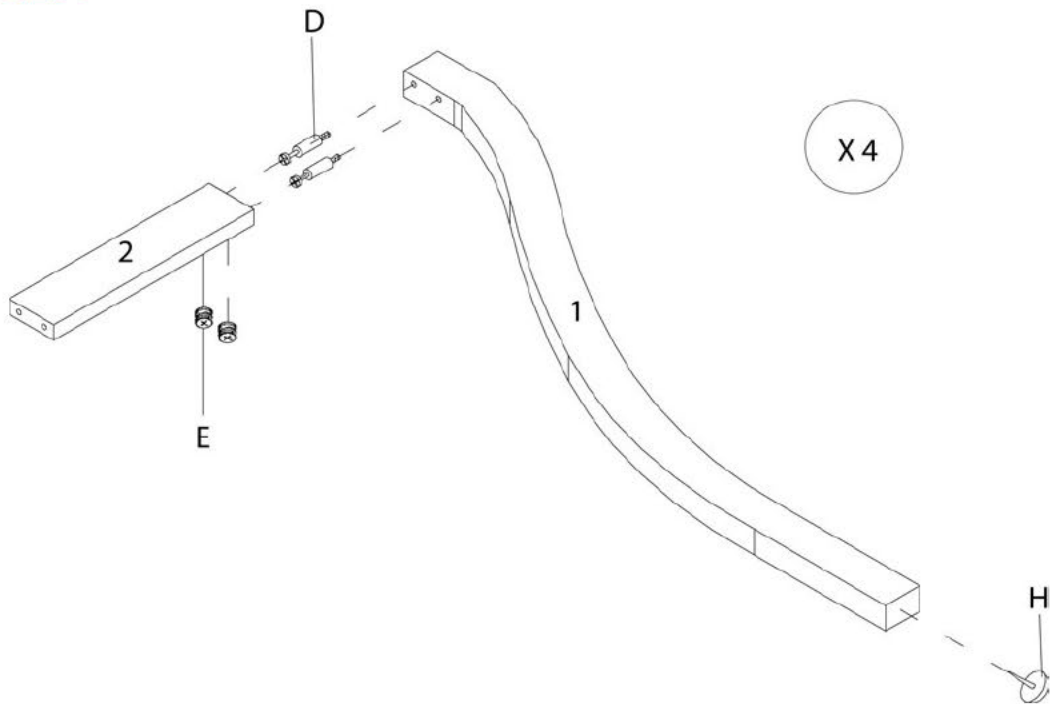

ÉTAPE / STEP 2

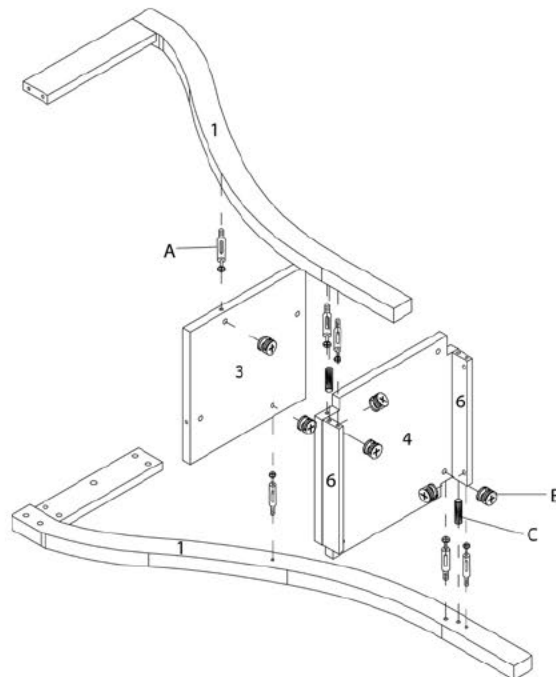

ÉTAPE / STEP 3

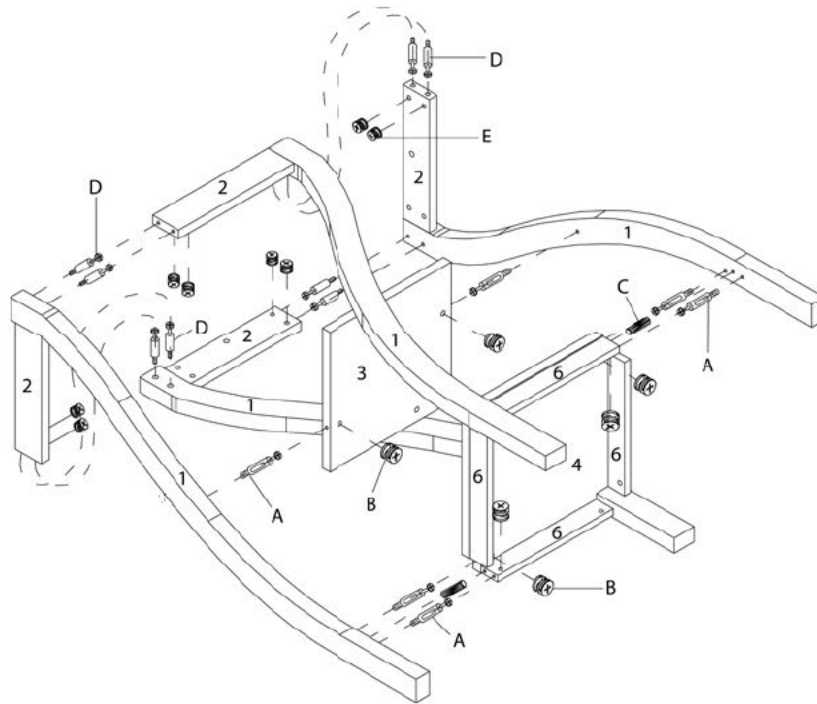

ÉTAPE / STEP 4

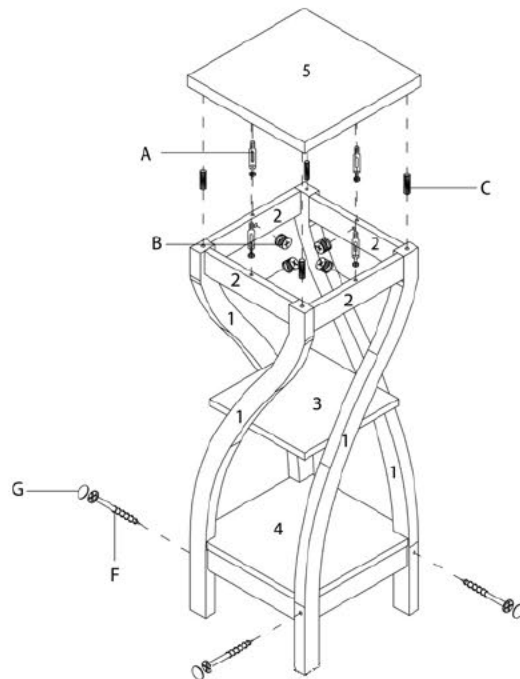

ÉTAPE / STEP 5

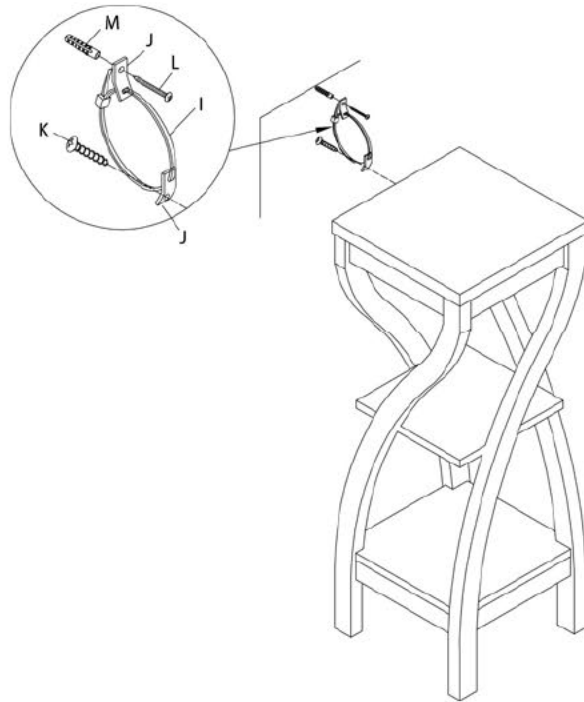

ÉTAPE / STEP 6

