

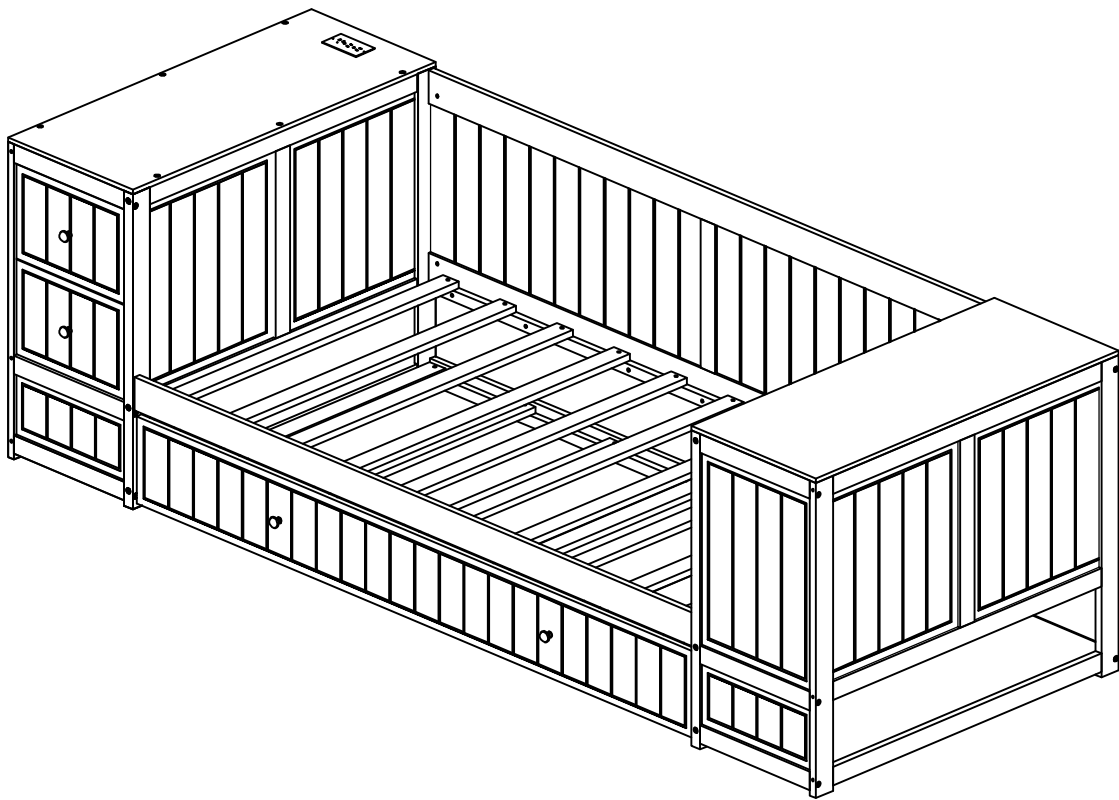

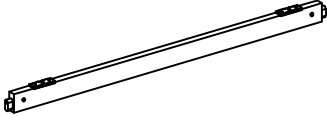







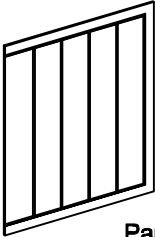
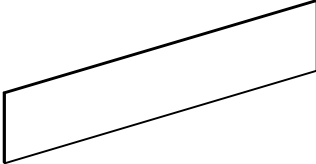

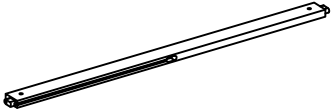

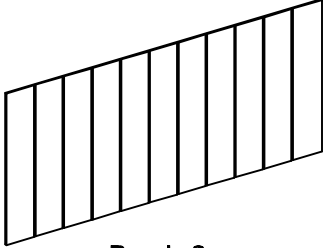
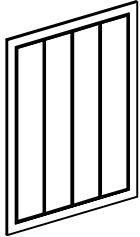
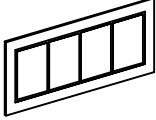
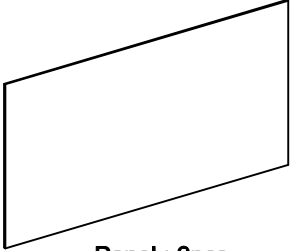
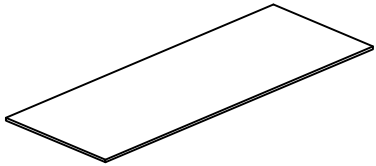
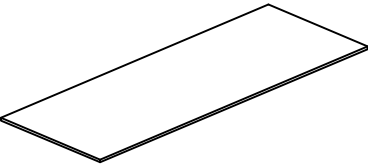
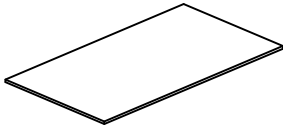
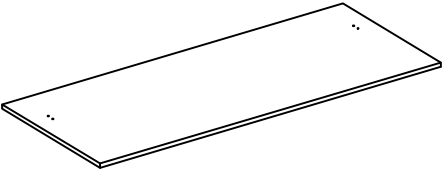
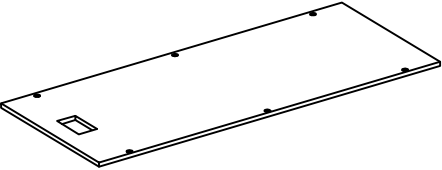
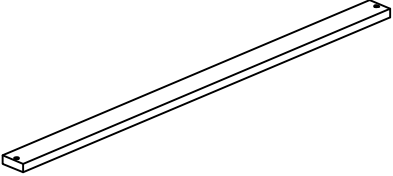
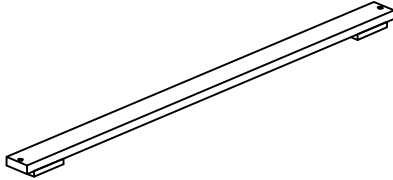
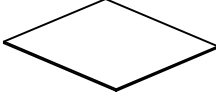
ASSEMBLY INSTRUCTION

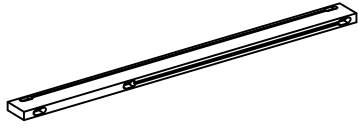
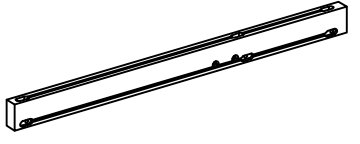
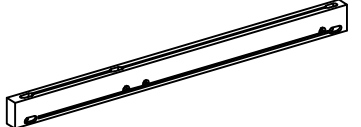
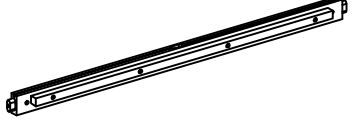
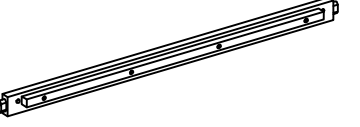
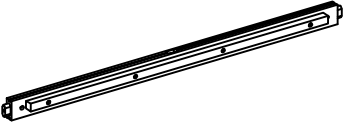
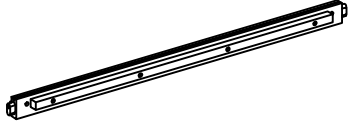

Part List & Hardware List

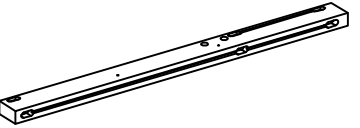
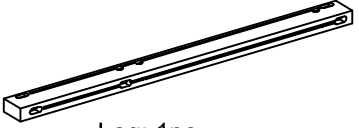
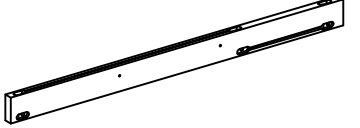
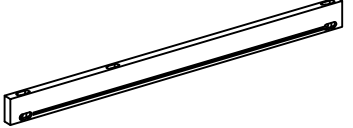
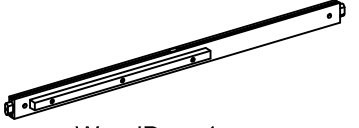
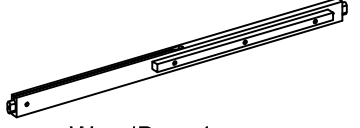
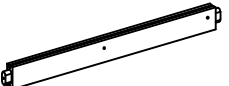
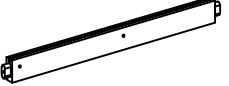
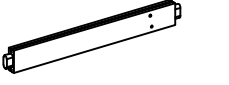
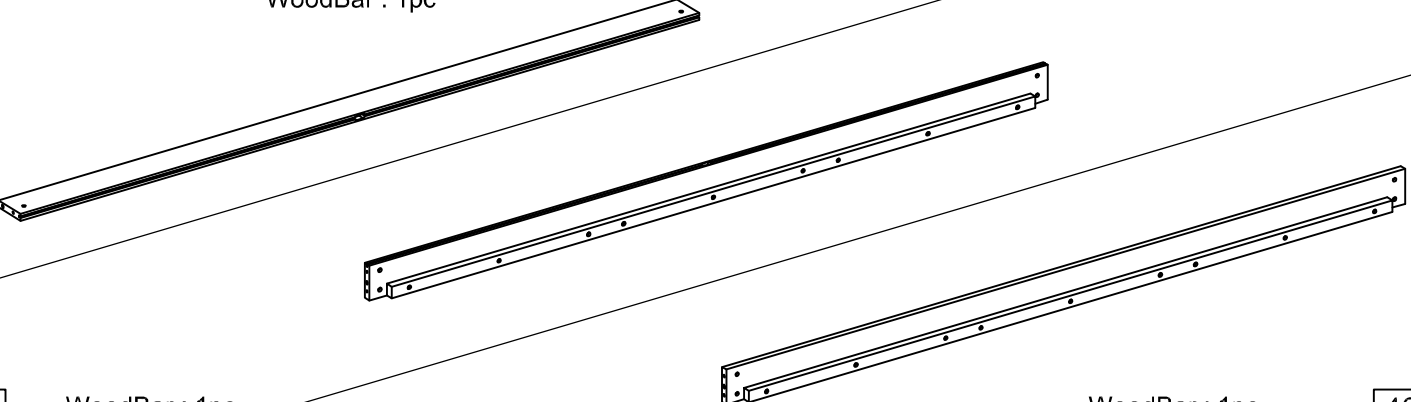
<p>1</p>  <p>WoodBar : 1pc</p>	<p>2</p>  <p>WoodBar : 1pc</p>	<p>3</p>  <p>Panel : 7pcs</p>
<p>4</p>  <p>Panel : 2pcs</p>	<p>5</p>  <p>WoodBar : 1pc</p>	<p>6</p>  <p>WoodBar : 1pc</p>
<p>7</p>  <p>WoodBar : 2pcs</p>	<p>8</p>  <p>WoodBar : 2pcs</p>	<p>9</p>  <p>Panel : 2pcs</p>
<p>10</p>  <p>Panel : 1pc</p>	<p>11</p>  <p>Panel : 2pcs</p>	<p>12</p>  <p>Panel : 2pcs</p>
<p>13</p>  <p>Panel : 2pcs</p>	<p>13A</p>  <p>Panel : 1pc</p>	<p>14</p>  <p>Panel : 1pc</p>
<p>15</p>  <p>Panel : 1pc</p>	<p>16</p>  <p>Panel : 1pc</p>	<p>17</p>  <p>WoodBar : 15pcs</p>
<p>18</p>  <p>WoodBar : 2pcs</p>	<p>19</p>  <p>Panel : 2pcs</p>	<p>3/18</p>

Part List

<p>20</p>  <p>Leg: 1pc</p>	<p>21</p>  <p>Leg: 1pc</p>	<p>22</p>  <p>Leg: 1pc</p>	
<p>23</p>  <p>Leg: 1pc</p>	<p>24</p>  <p>WoodBar : 1pc</p>	<p>25</p>  <p>WoodBar : 2pc</p>	
<p>26</p>  <p>WoodBar : 1pc</p>	<p>27</p>  <p>WoodBar : 2pcs</p>	<p>28</p>  <p>WoodBar : 2pcs</p>	
<p>29</p>  <p>Leg: 1pc</p>	<p>30</p>  <p>Leg: 1pc</p>	<p>31</p>  <p>Leg: 1pc</p>	
<p>32</p>  <p>Leg: 1pc</p>	<p>33</p>  <p>WoodBar : 1pc</p>	<p>34</p>  <p>WoodBar : 1pc</p>	
<p>35</p>  <p>WoodBar : 1pc</p>	<p>36</p>  <p>WoodBar : 1pc</p>	<p>37</p>  <p>WoodBar : 1pc</p>	
<p>38</p>  <p>WoodBar : 1pc</p>			<p>40</p>
<p>39</p> <p>WoodBar : 1pc</p>	<p>41</p>  <p>WoodBar : 1pc</p>	<p>42</p>  <p>WoodBar : 1pc</p>	<p>43</p>  <p>WoodBar : 1pc</p>
			<p>4/18</p>

Part List

44



WoodBar : 1pc

45



WoodBar : 1pc

46



WoodBar : 4pcs

47

Panel : 1pc

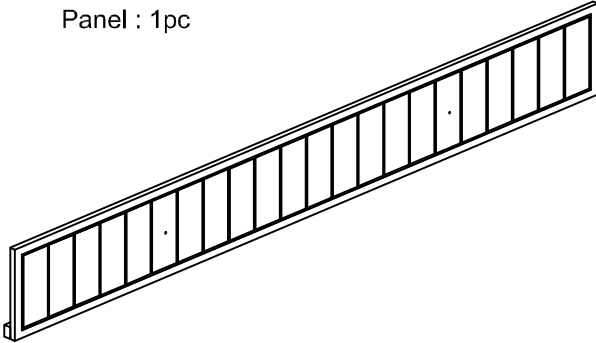

Panel : 1pc

48

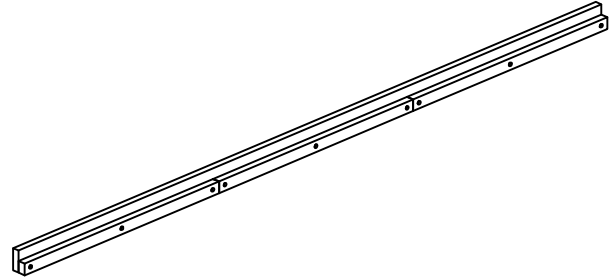

WoodBar : 1pc

49

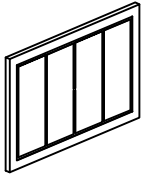

Panel : 2pcs

50

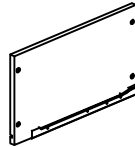

Panel : 2pcs

51

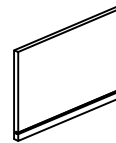

Panel : 2pcs

52

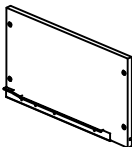







Panel : 2pcs

53

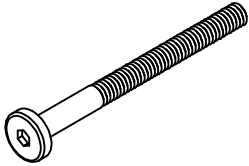

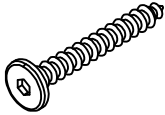
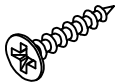
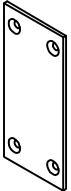
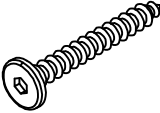
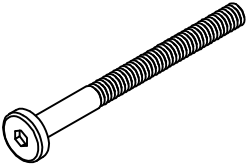
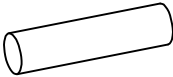
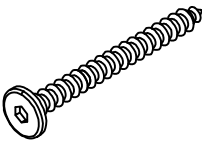
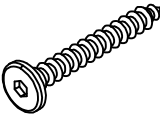
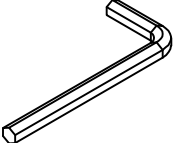
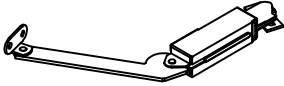
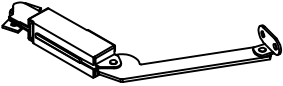

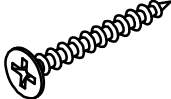
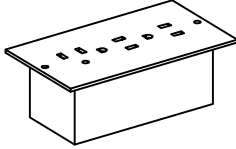
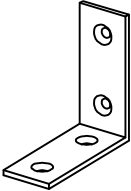
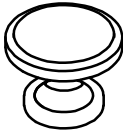
WoodBar : 1pc

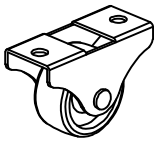
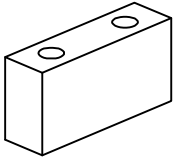
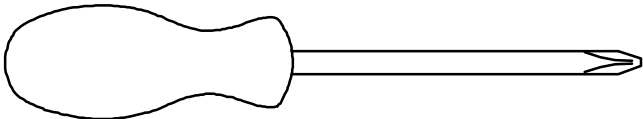
Hardware List

<p>A</p>  <p>Ø1/4" x 100 mm Hex-Head bolts: 24pcs</p>	<p>B</p>  <p>Ø1/4" x 13 mm Horizontal-Hole bolts: 34pcs</p>	<p>C</p>  <p>Ø1/4" x 30 mm Hexagonal bolts catch wood: 12pcs</p>	<p>D</p>  <p>4 x 15 mm Wood Screws: 28pcs</p>
<p>E</p>  <p>Pat: 2pcs</p>	<p>F</p>  <p>Ø1/4" x 50 mm Hexagonal bolts catch wood: 20pcs</p>	<p>G</p>  <p>Ø1/4" x 80 mm Hex-Head bolts: 10pcs</p>	<p>H</p>  <p>Ø10 x 40 mm Wood dowel: 6pcs</p>
<p>I</p>  <p>Ø1/4" x 80 mm Hexagonal bolts catch wood: 2pcs</p>	<p>J</p>  <p>Ø1/4" x 60 mm Hexagonal bolts catch wood: 6pcs</p>	<p>K</p>  <p>Allen Key: 1pc</p>	<p>L</p>  <p>Cabinet Wood Box (left): 1pc</p>
<p>M</p>  <p>Cabinet Wood Box (right): 1pc</p>	<p>N</p>  <p>3 x 12 mm Wood Screws: 16pcs</p>	<p>O</p>  <p>4 x 30 mm Wood Screws: 54pcs</p>	<p>P</p>  <p>1pc</p>
<p>Q</p>  <p>Pat: 3pcs</p>	<p>R</p>  <p>Handles: 4pcs</p>	<p>S</p>  <p>M4 x 25 mm Hex-Head bolts: 4pcs</p>	<p>T</p>  <p>Wheels: 4pcs</p>
<p>V</p>  <p>WoodBar : 2pcs</p>			



Assembly Tools Required (Not Included)

STEP 1

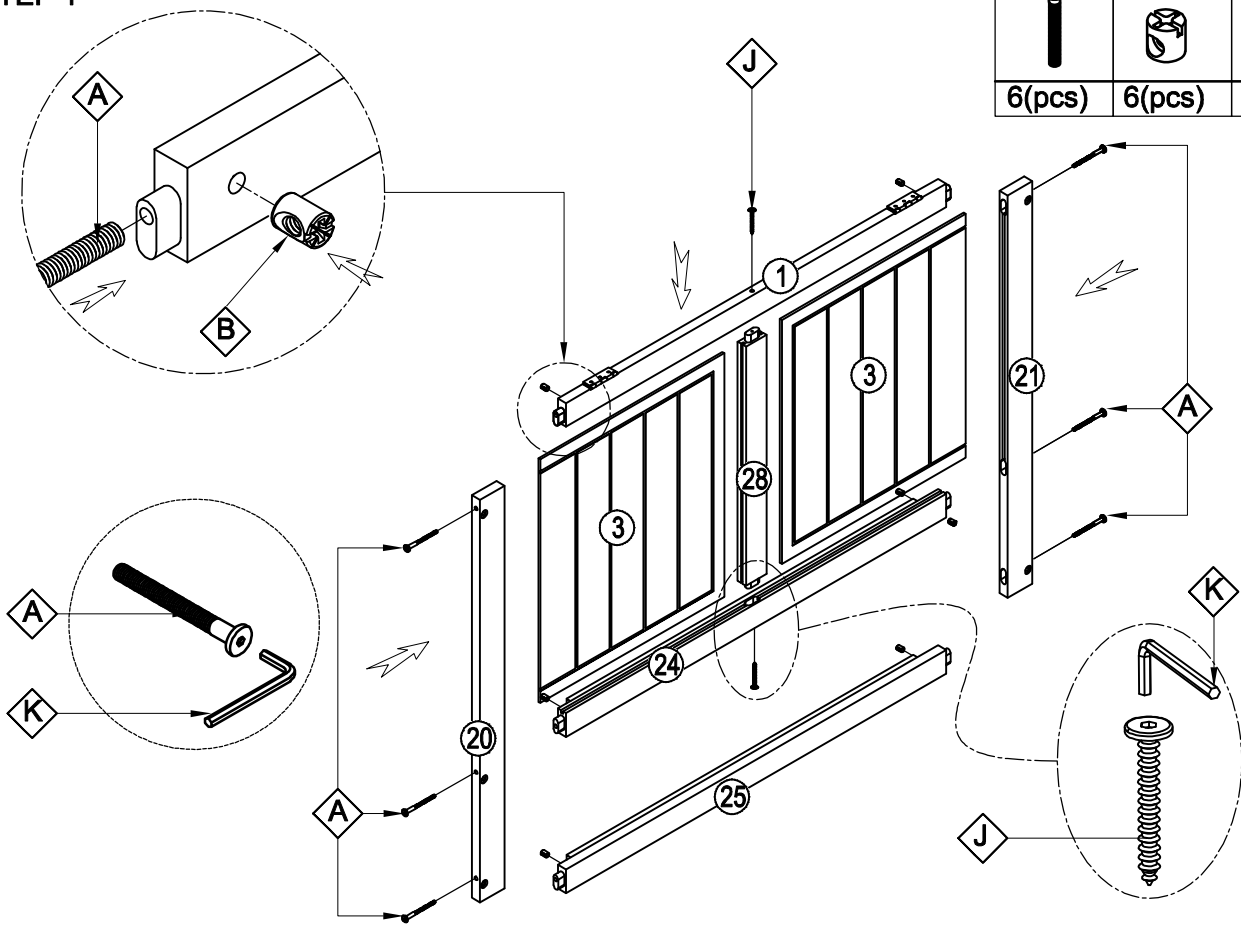
A	B	J
		
6(pcs)	6(pcs)	2(pcs)



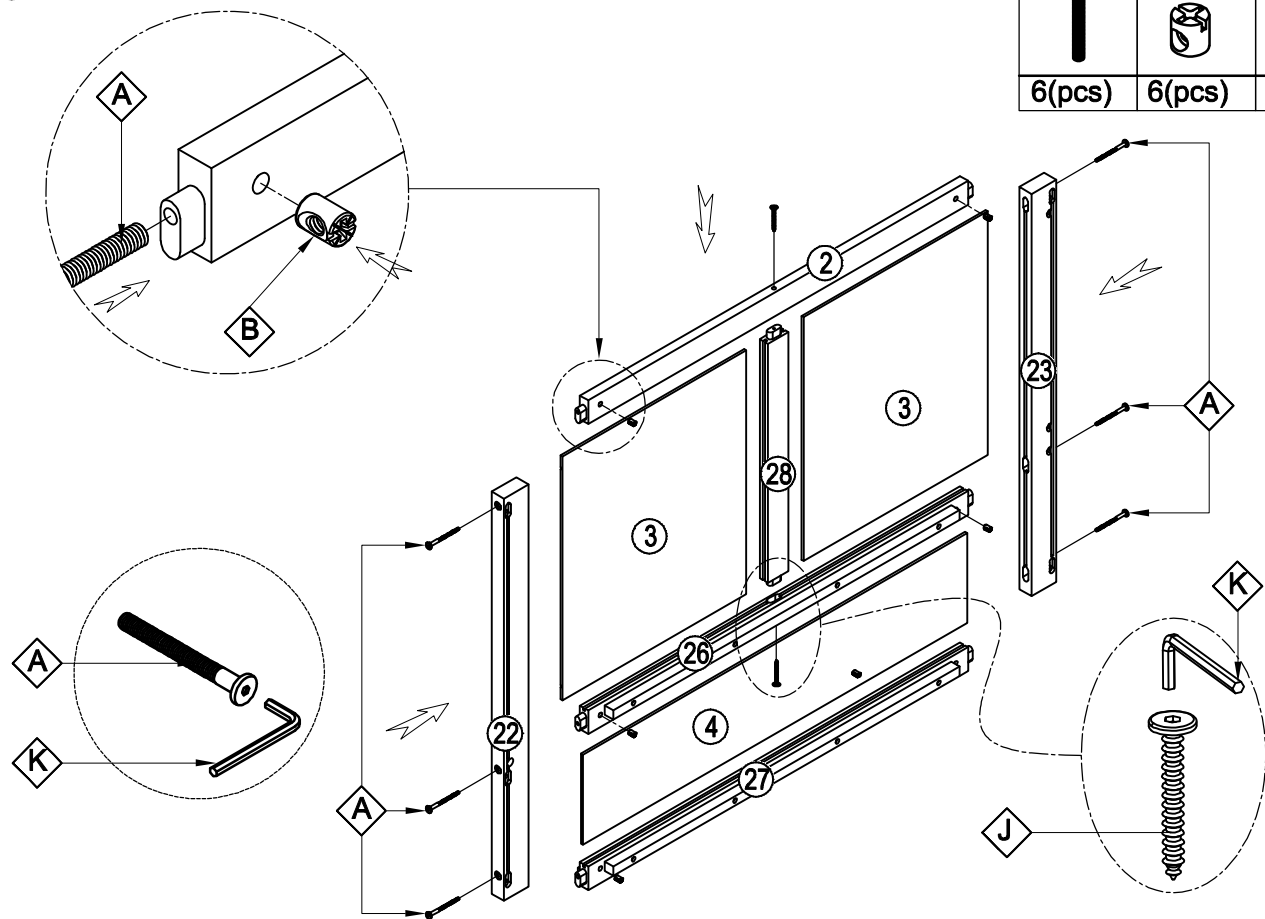

STEP 2

A	B	J
		
6(pcs)	6(pcs)	2(pcs)



STEP 3

A	B	J
		
6(pcs)	6(pcs)	1(pc)

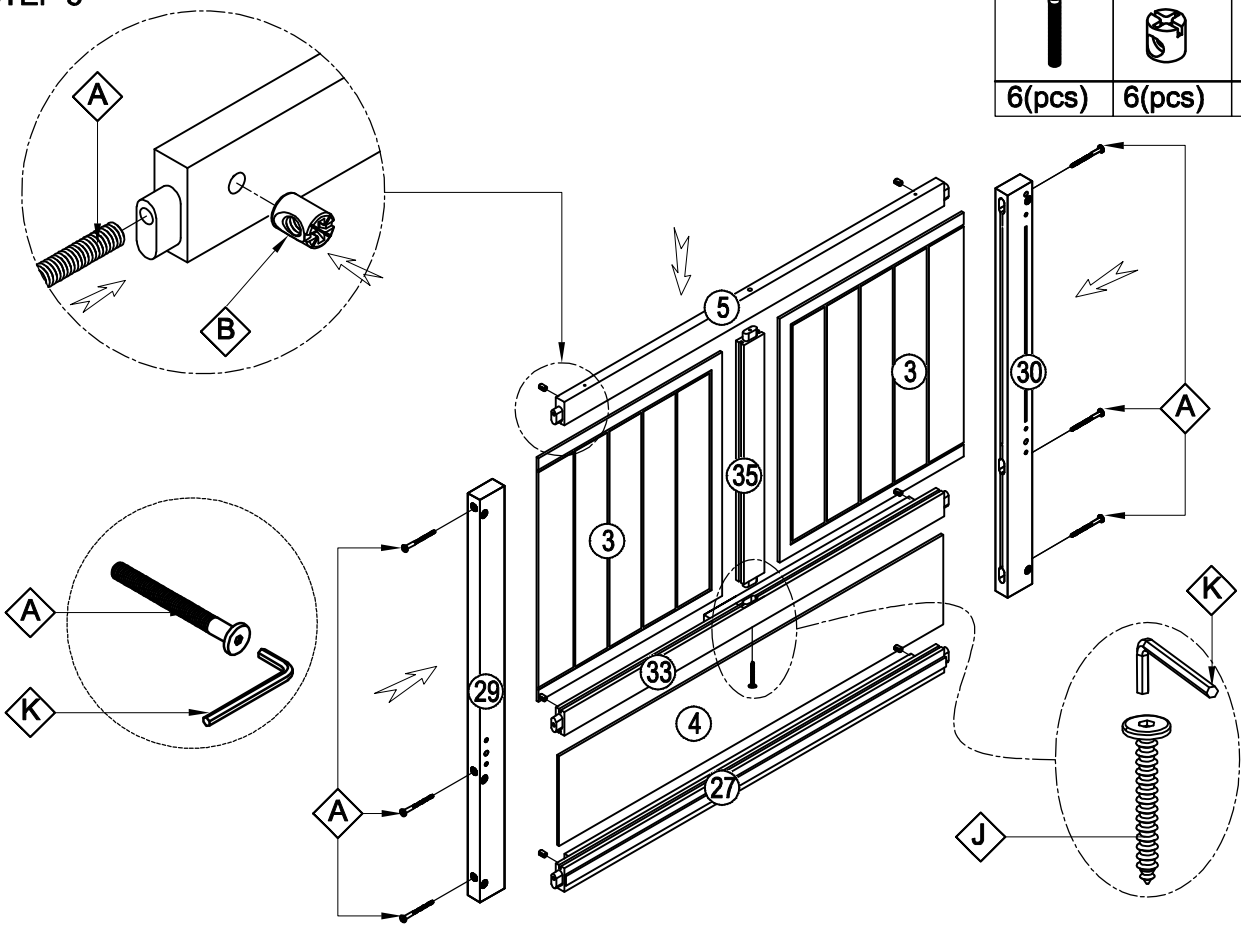

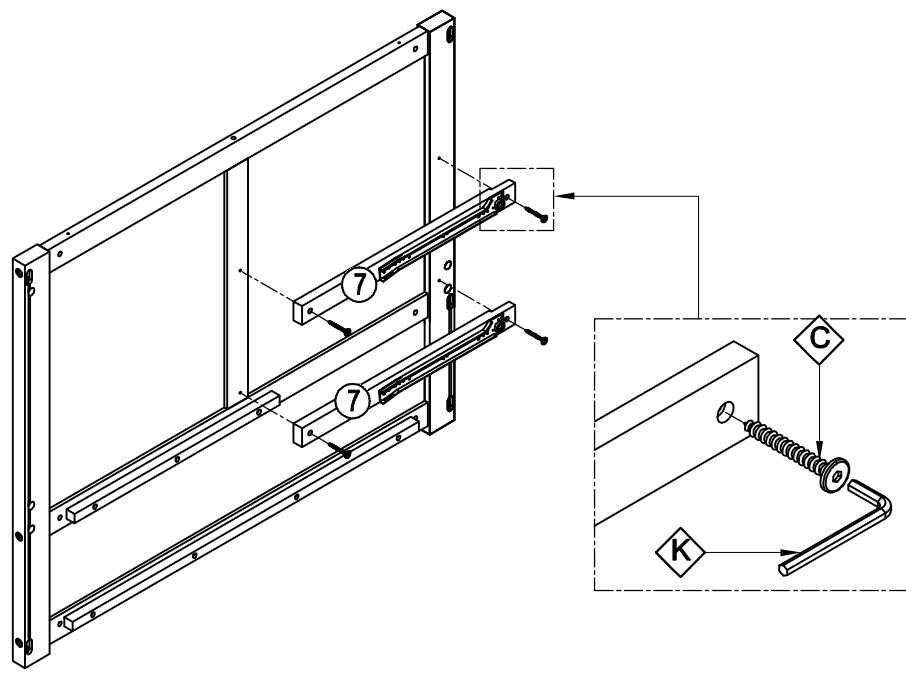

STEP 4

C

4(pcs)

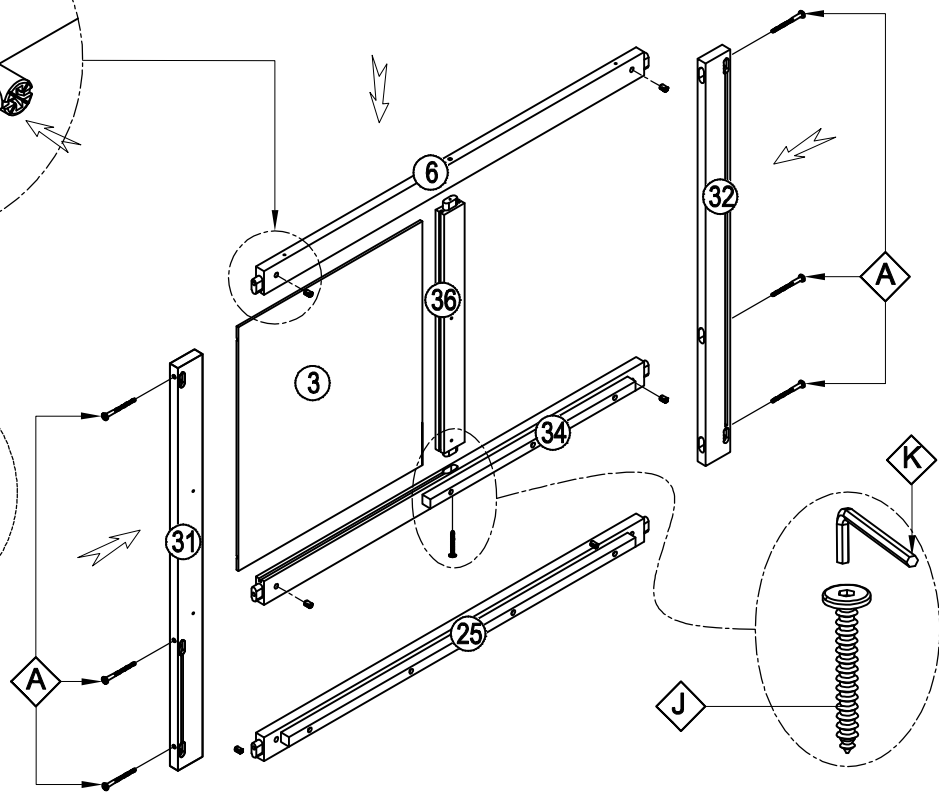
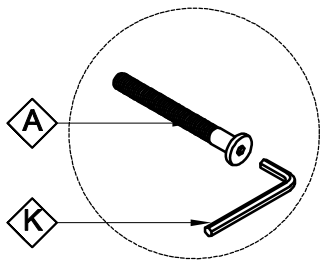
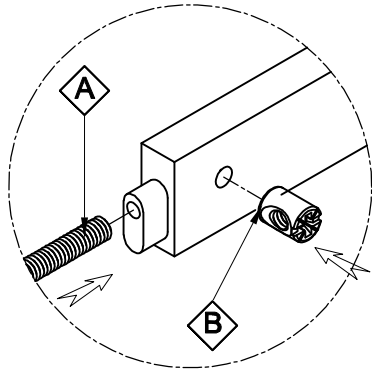

STEP 5

A	B	J
		
6(pcs)	6(pcs)	1(pc)



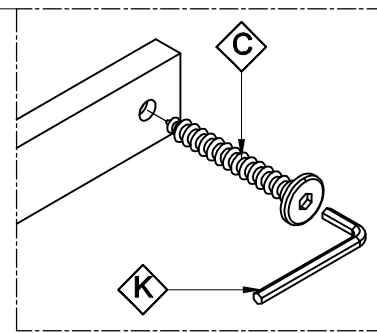
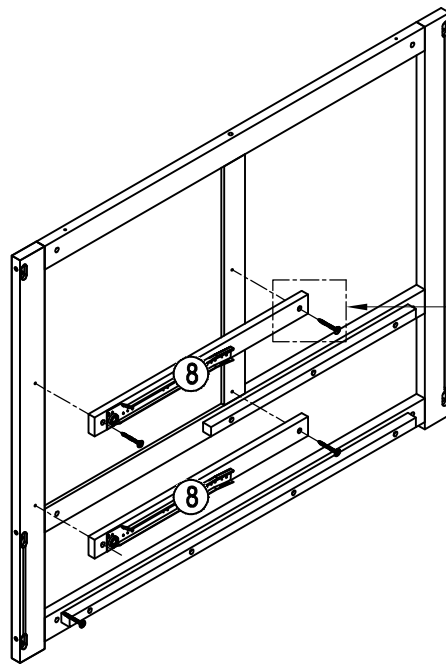

STEP 6

C

4(pcs)



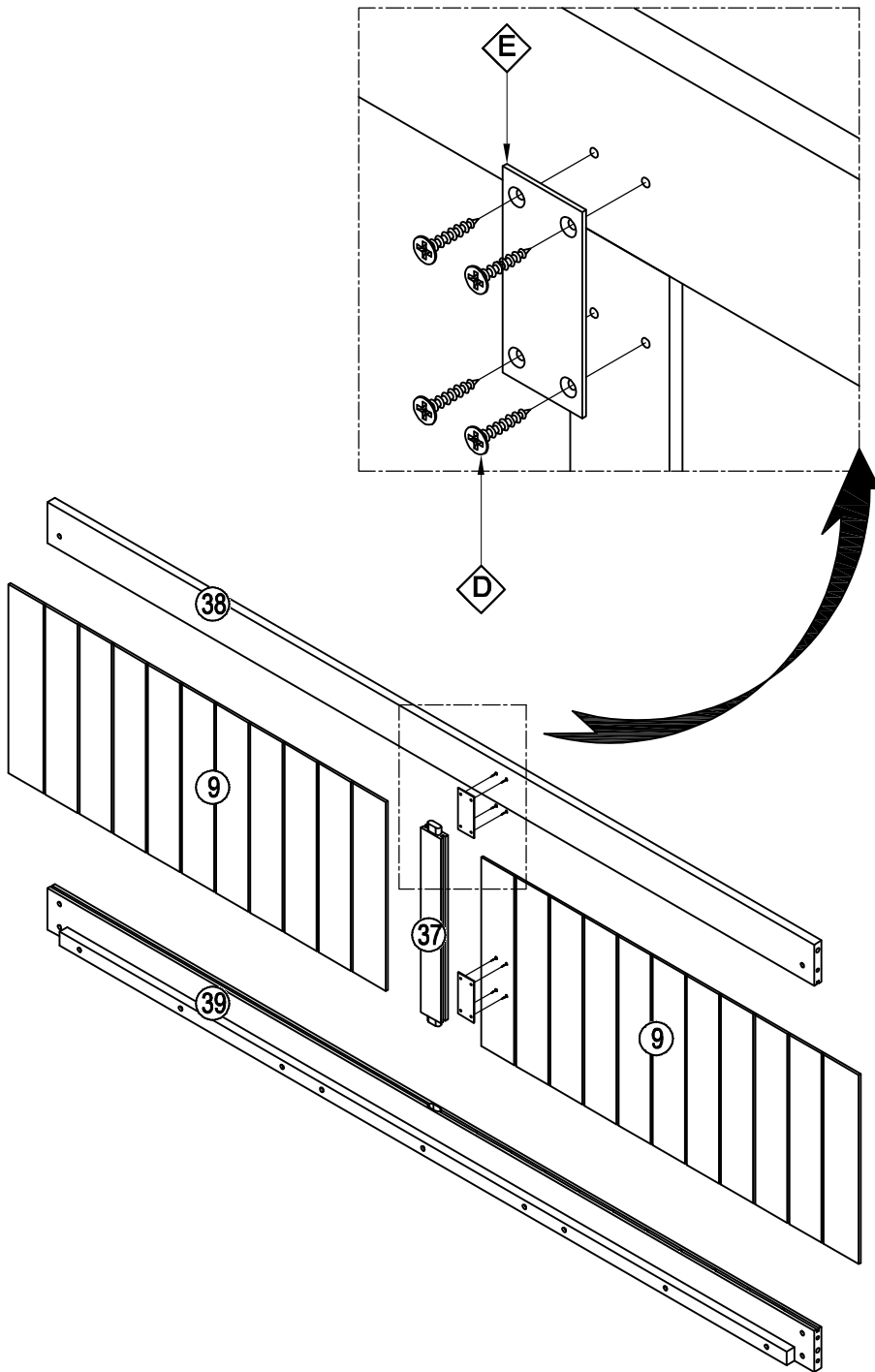

STEP 7

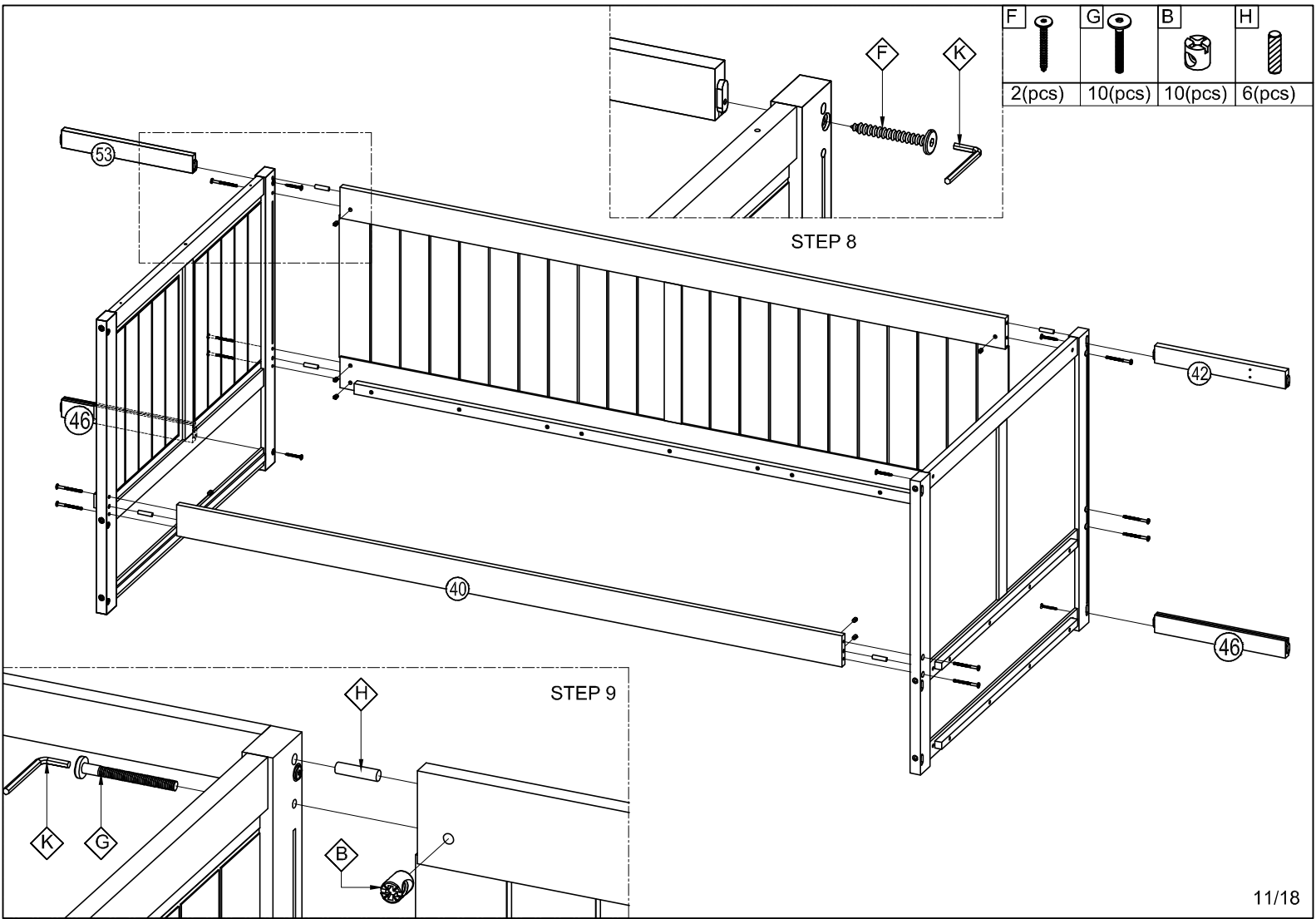
D	E
	
8(pcs)	2(pcs)





STEP 10



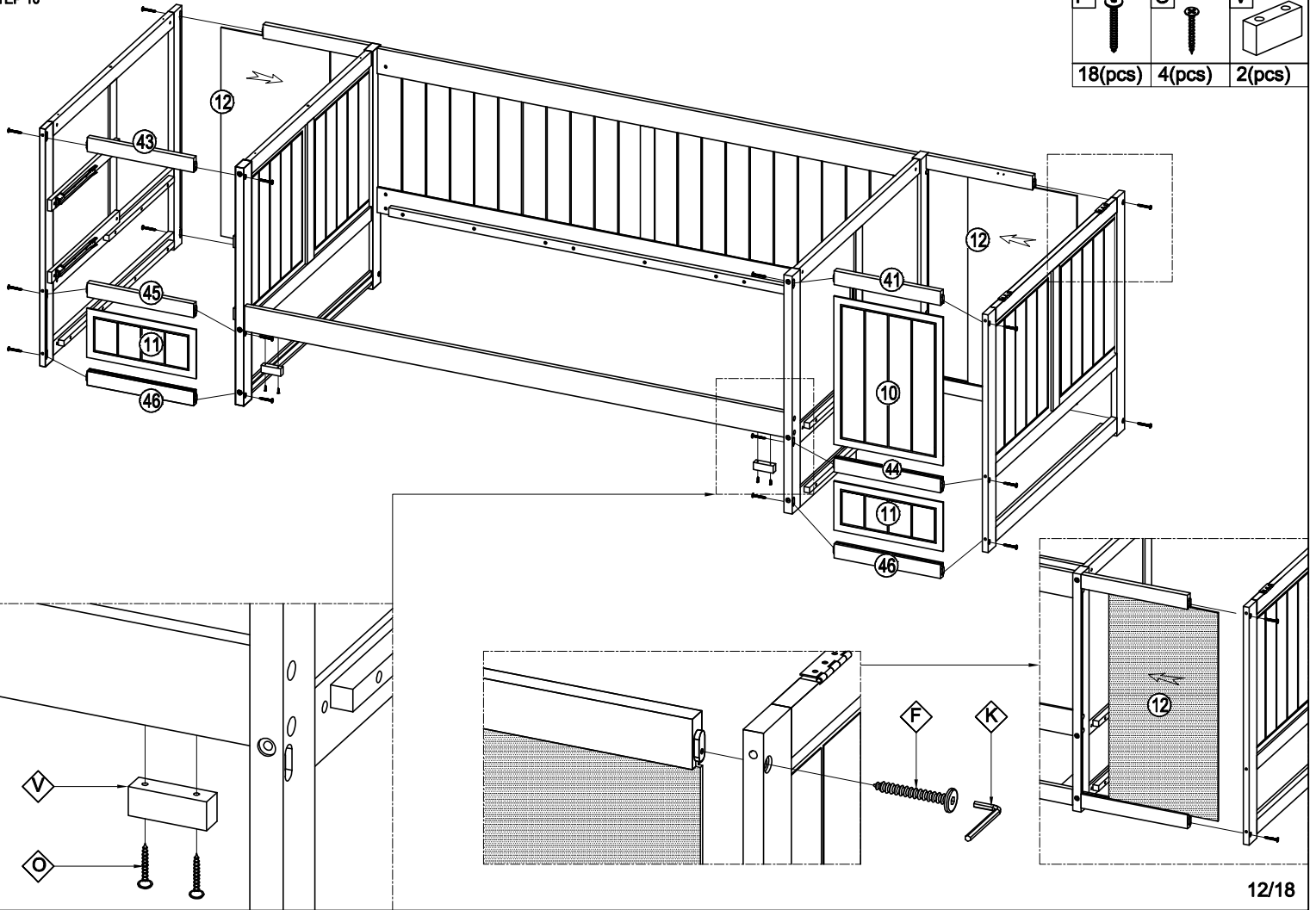

F	O	V
		
18(pcs)	4(pcs)	2(pcs)

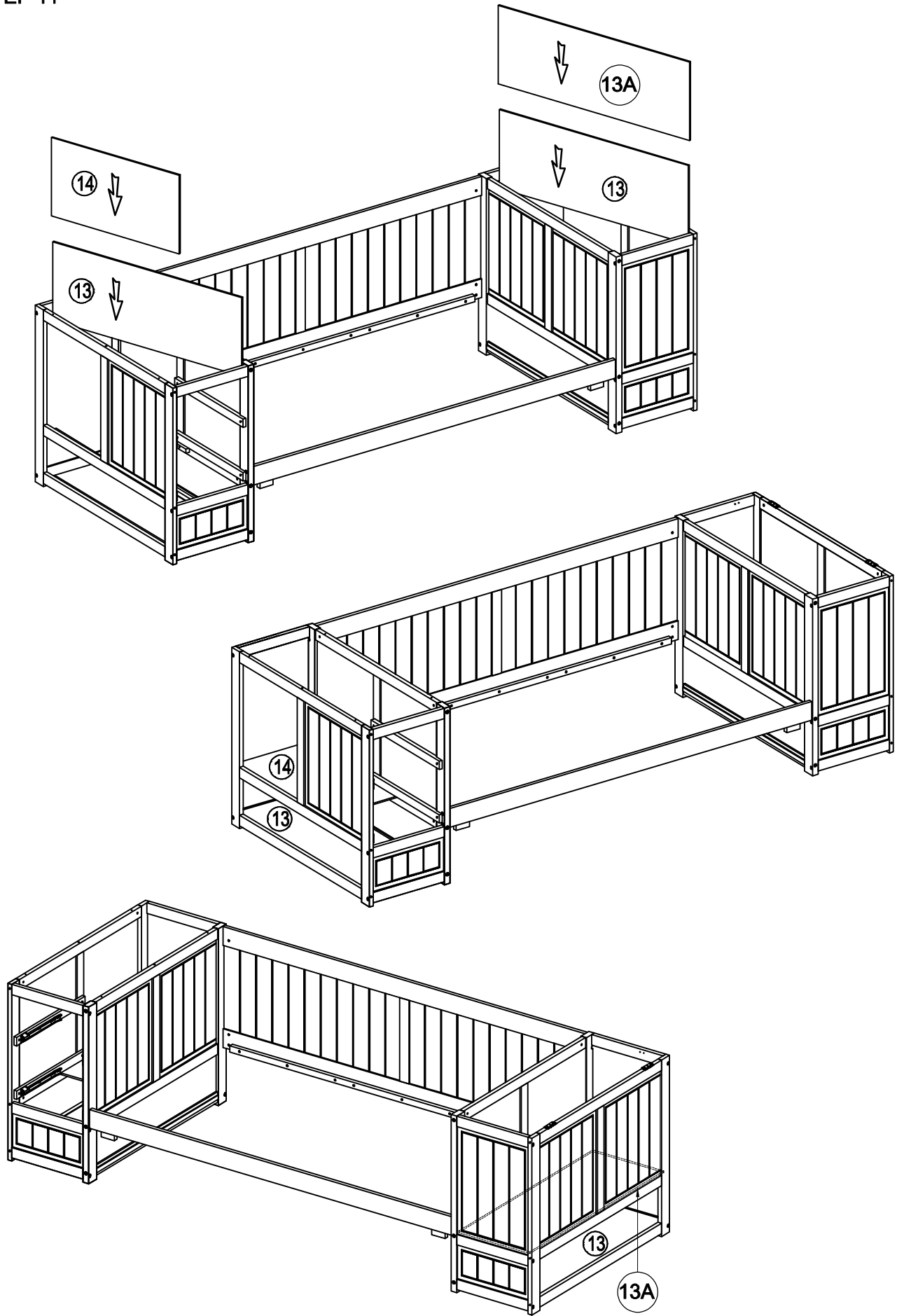

STEP 11



STEP 12

C	I	L	M	N
				
4(pcs)	2(pcs)	1(pc)	1(pc)	14(pcs)

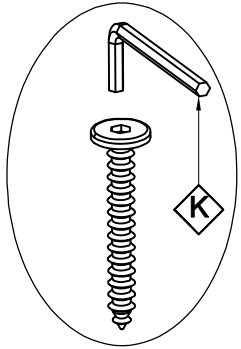

STEP 15

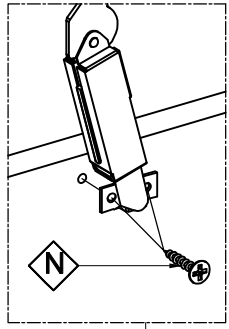

STEP 14

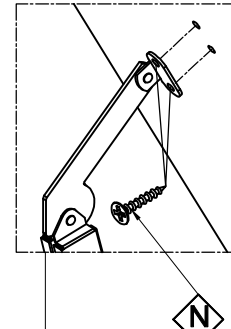

STEP 13

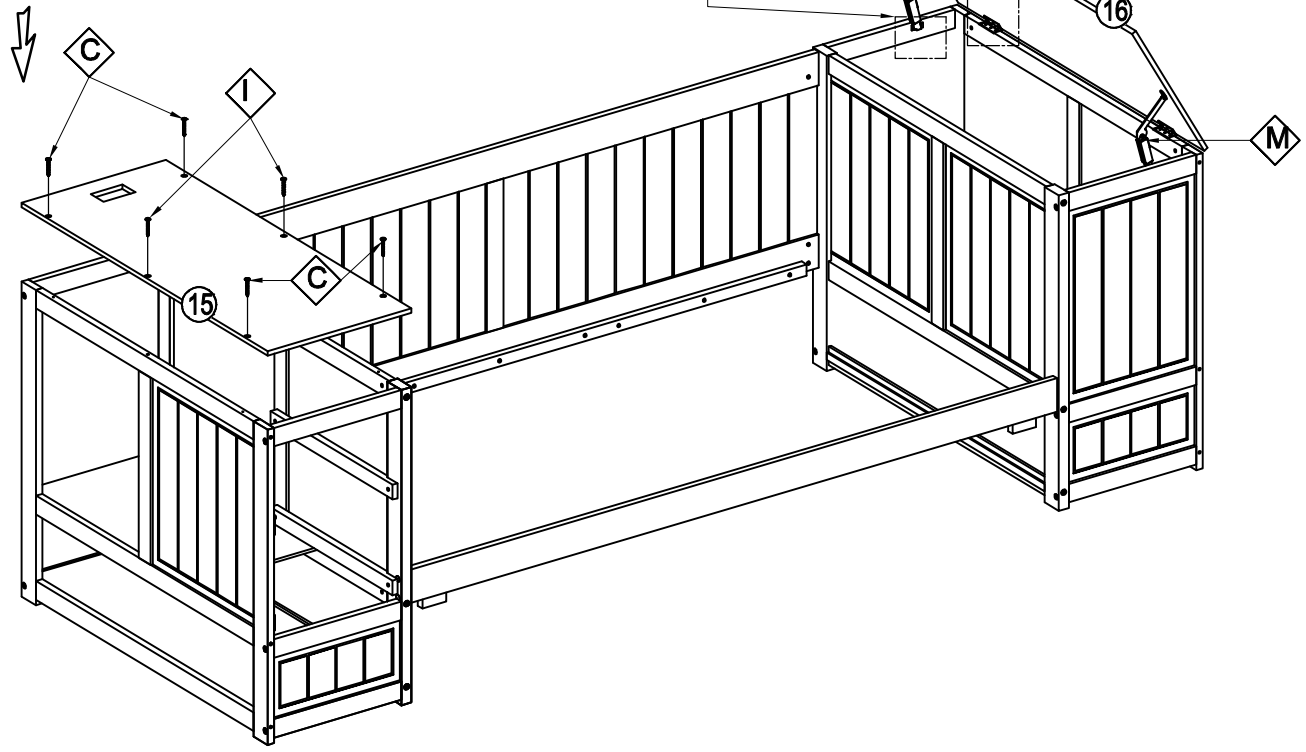
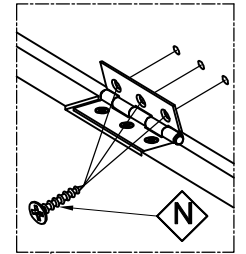





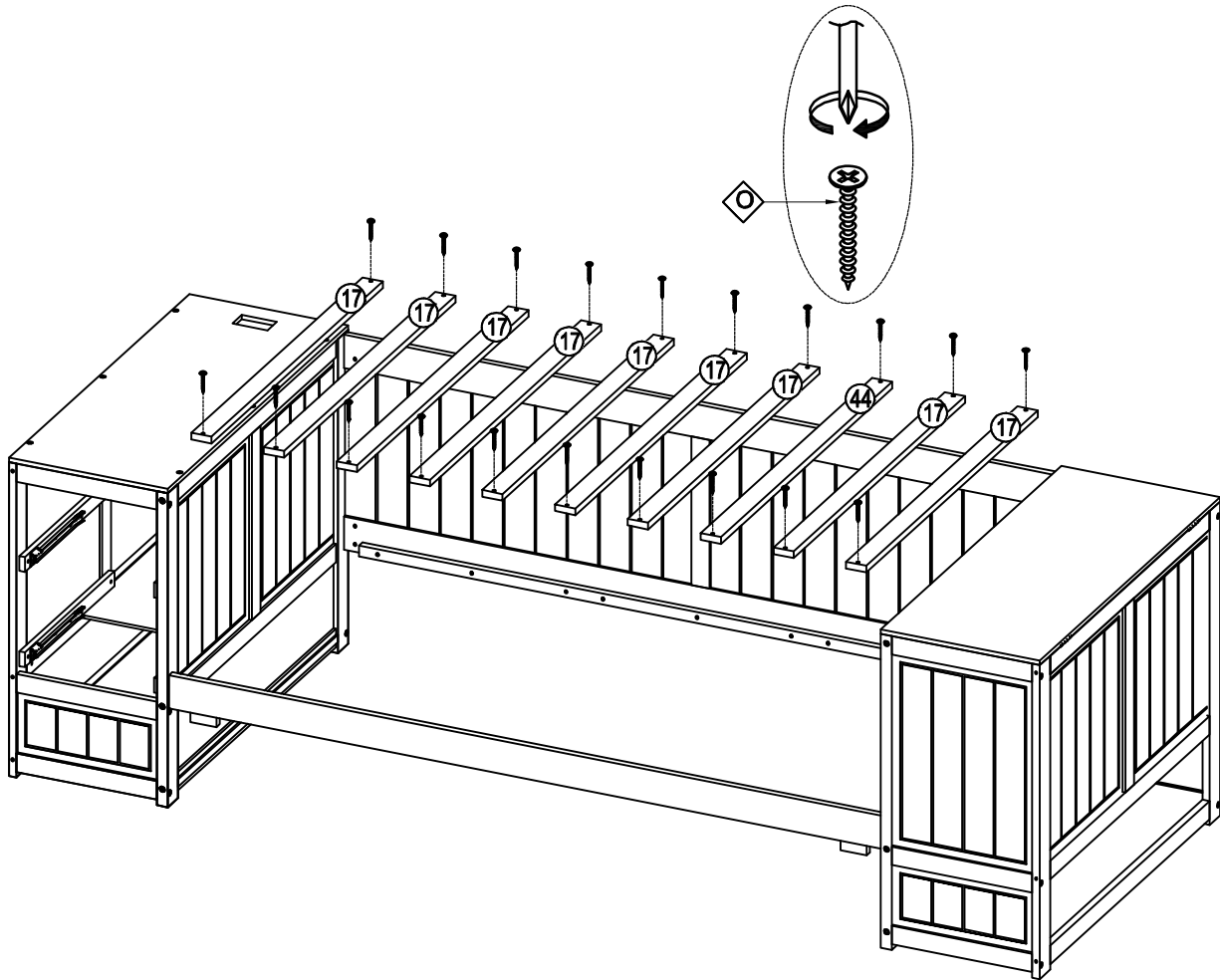

STEP 16

O
20(pcs)



STEP 17

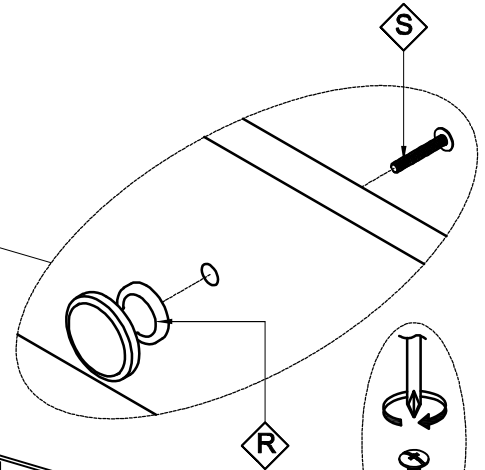
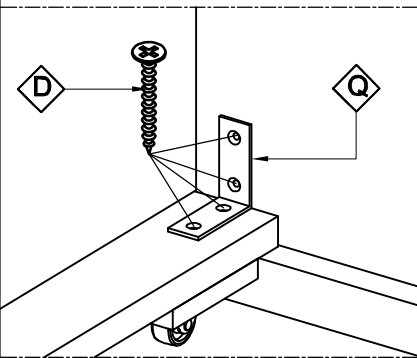
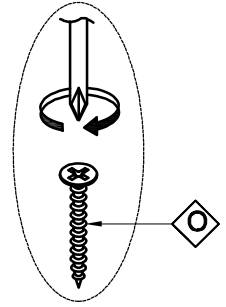
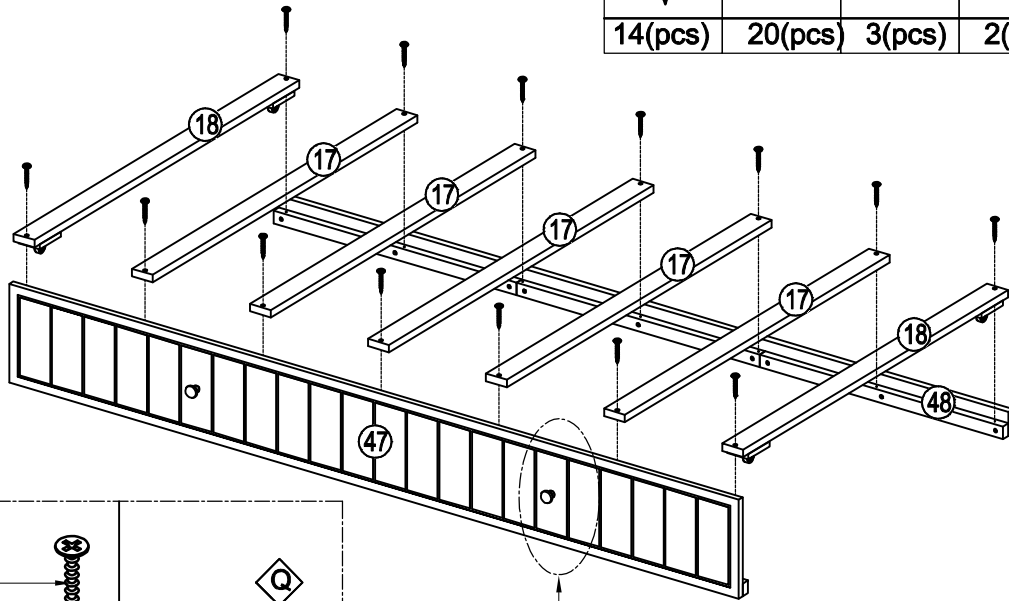

O	D	Q	R	S	T
					
14(pcs)	20(pcs)	3(pcs)	2(pcs)	2(pcs)	4(pcs)

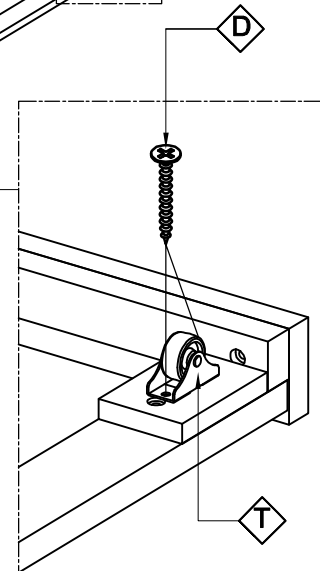
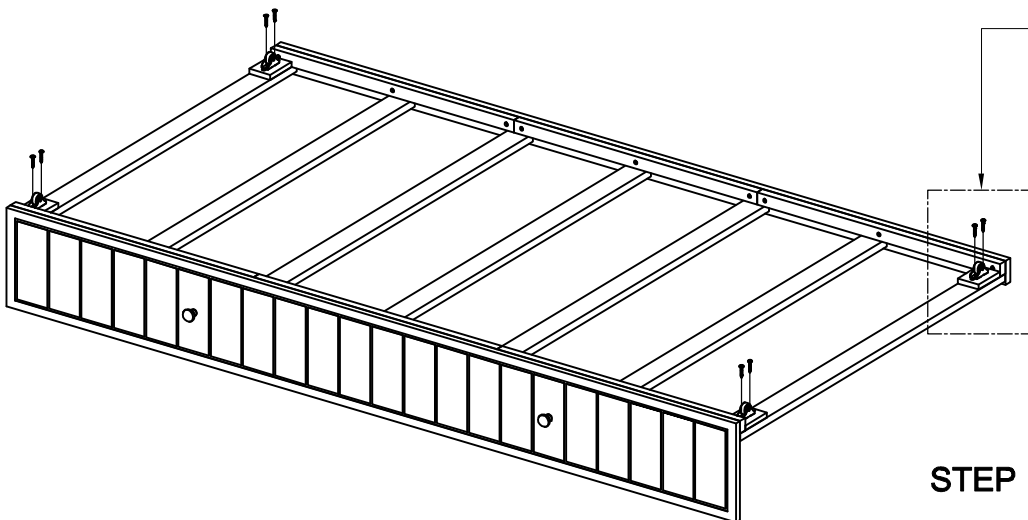
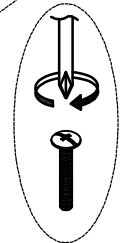
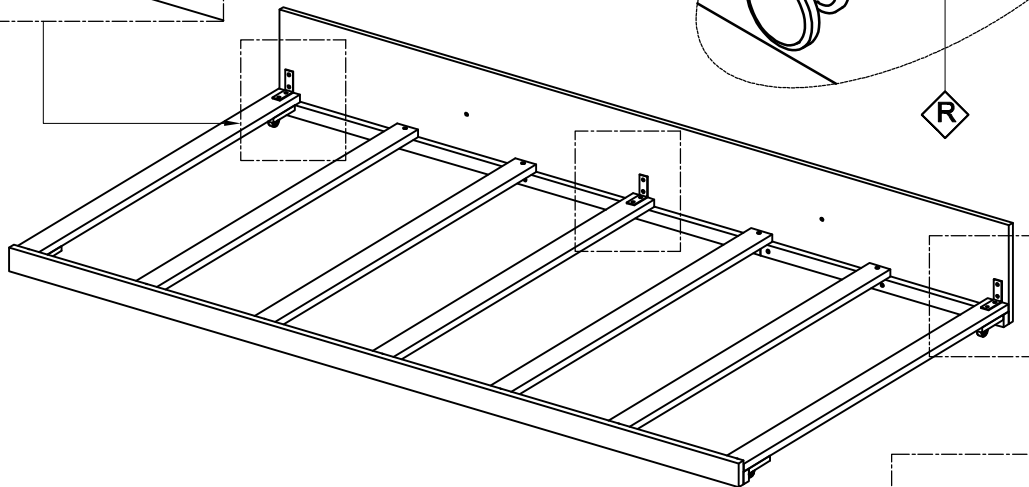

STEP 18



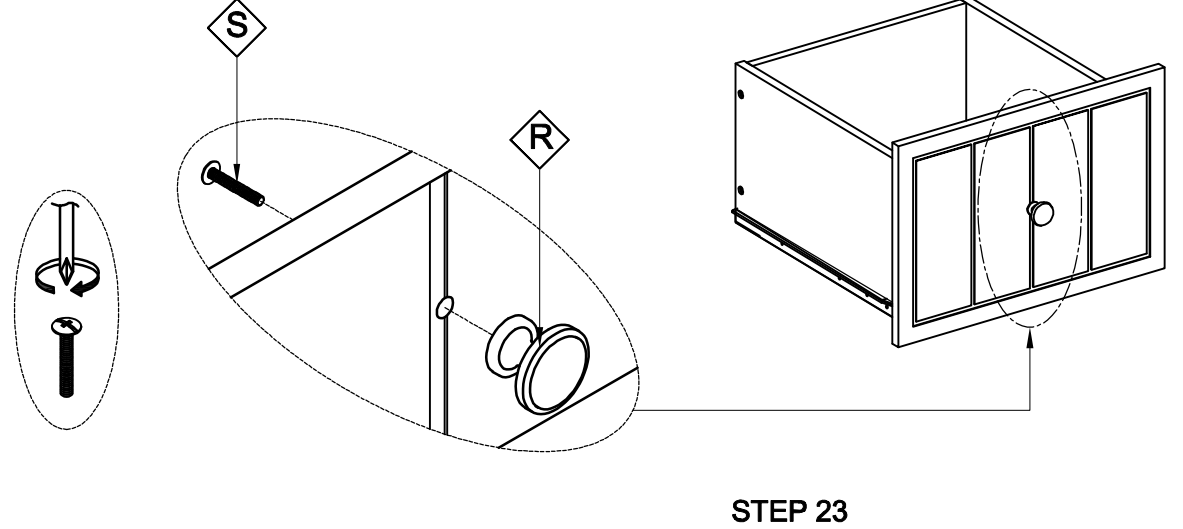
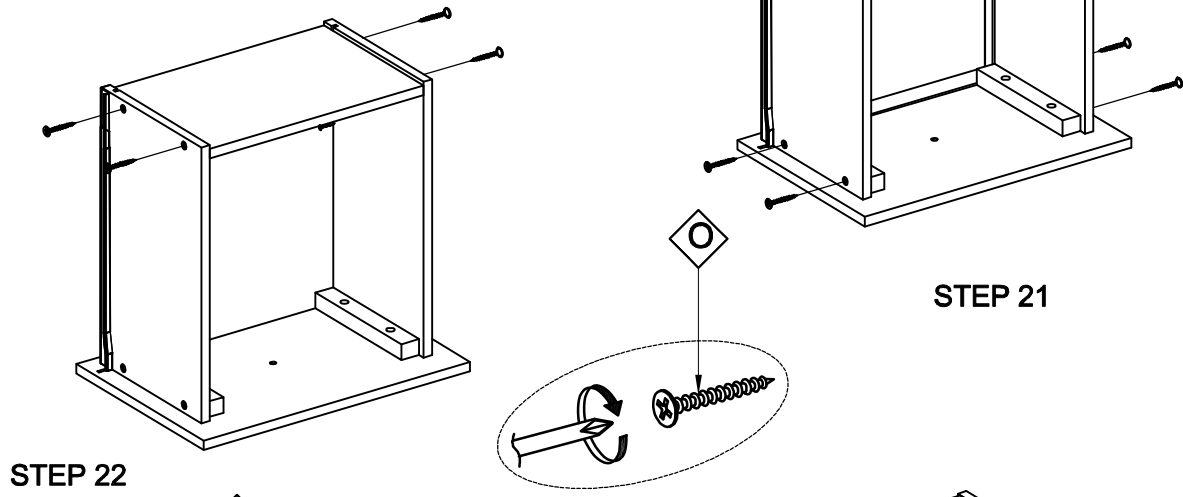
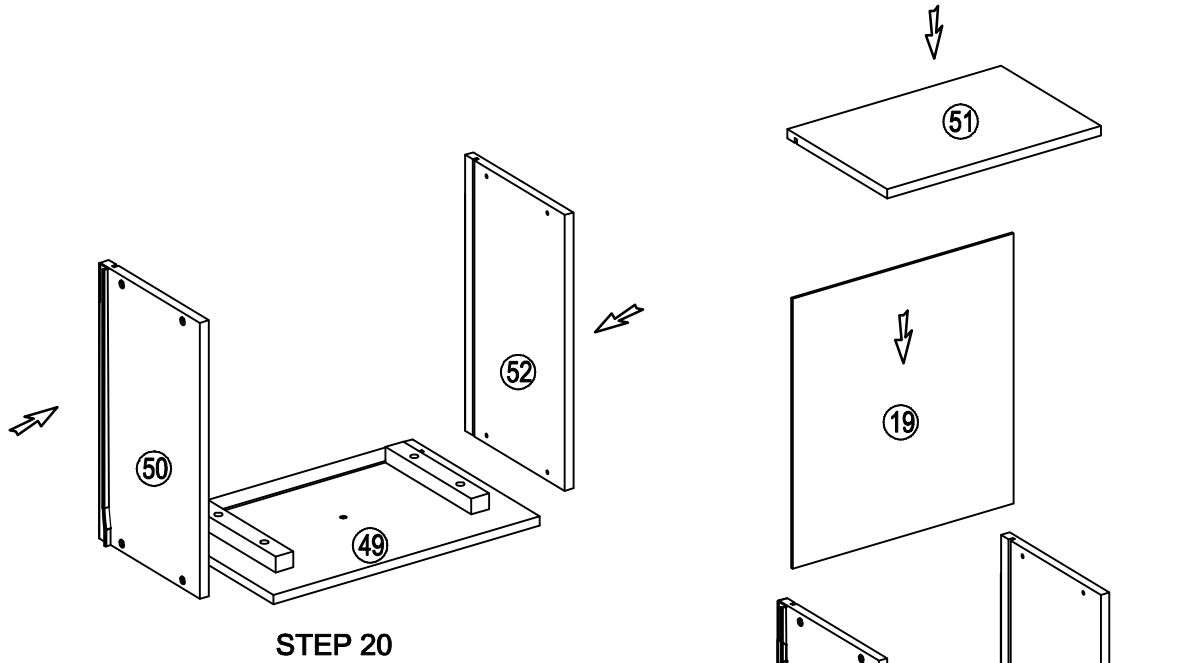

STEP 19

O	R	S
		
16(pcs)	2(pcs)	2(pcs)



STEP 24

V	N
	
1(pcs)	2(pcs)

