

Notice:

1. Follow the installation instructions. Please confirm all accessories are present before installation.
2. Do not fully tighten the screws during initial assembly. Fully tighten screws only once all pieces which are correctly assembled.
3. If you encounter any problems during installation, please contact our customer service.
4. Please unbox the item from the side with an open-label and put a carpet on the floor to avoid scratching it.



Recommended installers : 2





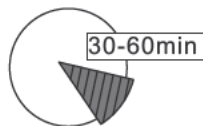















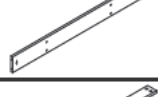

Put a carpet on the floor
before unpacking



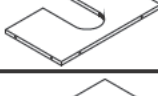

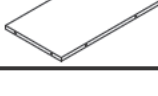





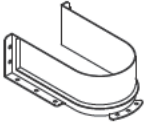

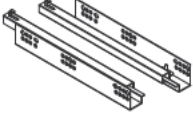
Estimate installation time:
30 minutes

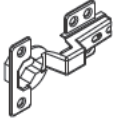
ASSEMBLY INSTRUCTIONS

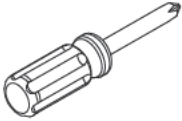
1		x1	13		x1
2		x1	14		x1
3		x1	15		x1
4		x1	16		x2
5		x1	17		x2
6		x1	18		x1
7		x1	19		x1
8		x1	20		x1
9		x2	21		x1
10		x1	22		x1
11		x1			
12		x1			

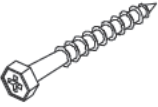
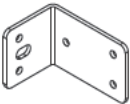
ASSEMBLY INSTRUCTIONS

<p>(A)</p>	 $\varnothing 6 \times 26 \text{mm}$	<p>x84</p>	<p>(J)</p>		<p>x1</p>
<p>(B)</p>	 $\varnothing 15 \times 9 \text{mm}$	<p>x84</p>	<p>(K)</p>		<p>x2</p>
<p>(C)</p>	 $\varnothing 3.5 \times 14 \text{mm}$	<p>x101</p>	<p>(L)</p>		<p>x8</p>
<p>(D)</p>		<p>x4</p>	<p>(M)</p>		<p>x1</p>
<p>(E)</p>		<p>x4</p>	<p>(N)</p>		<p>x1</p>
<p>(F)</p>		<p>x4</p>			
<p>(G)</p>		<p>x4</p>			
<p>(H)</p>		<p>x2</p>			
<p>(I)</p>		<p>x6</p>			

ASSEMBLY INSTRUCTIONS

Use the Cam Lock and Eccentric Wheel

ECCENTRIC WHEEL

Tighten the bolt until the shoulder is aligned with the panel.
Be sure not to tighten too much or too little.

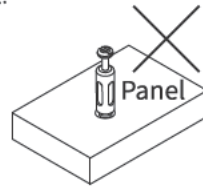
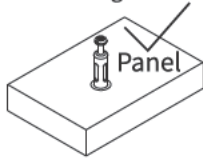

The pre-inserted nut should align with the center of the cam lock when joining two panels. The cam lock should be inserted before the eccentric wheel.

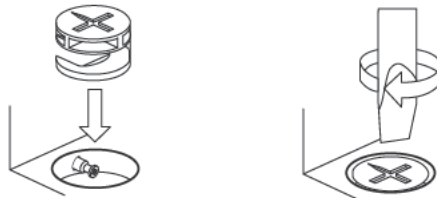

Turn the cam lock clockwise to tighten

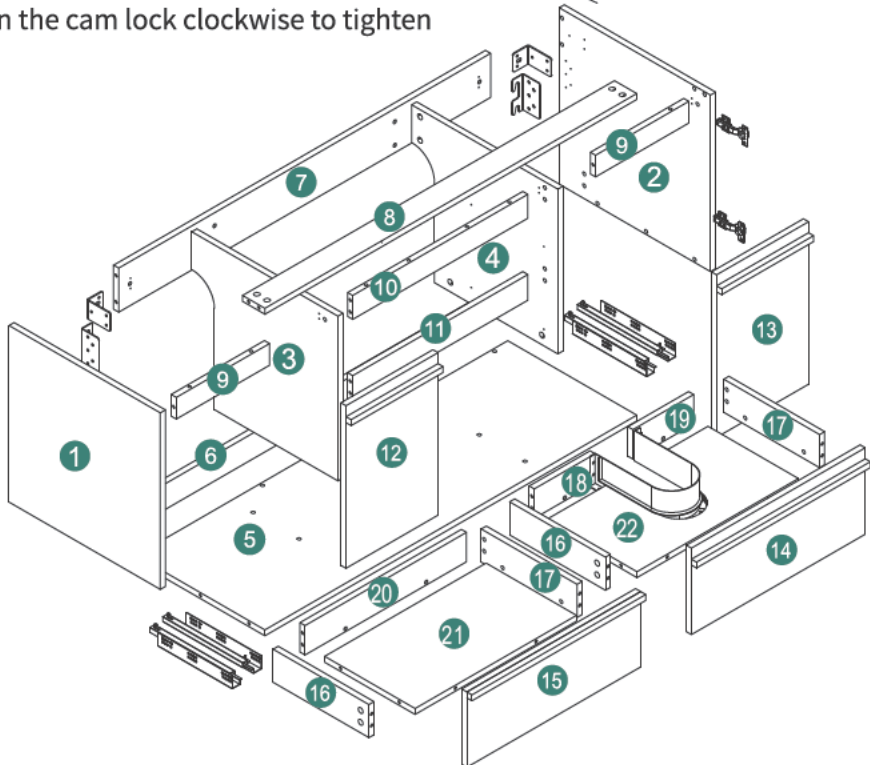

ASSEMBLY INSTRUCTIONS

1



(A) 84 pcs



The floor needs to be covered with paper or carpet protective material before installation!

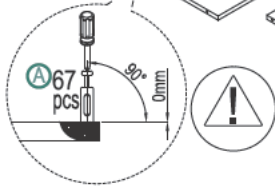
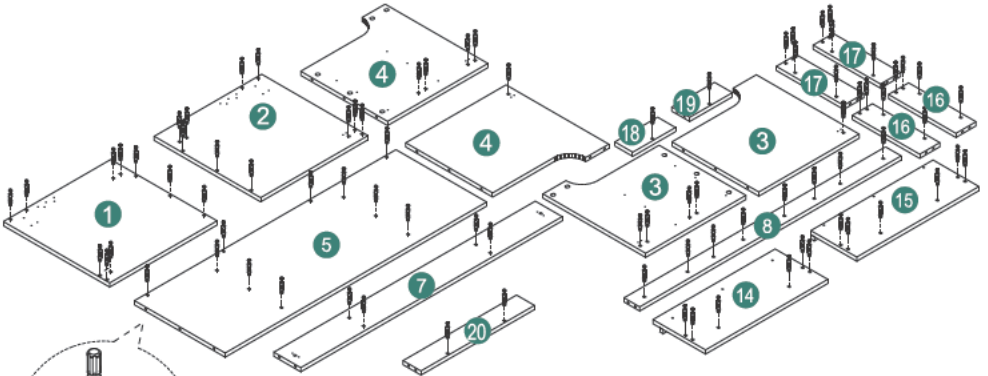

2



(B) 52 pcs

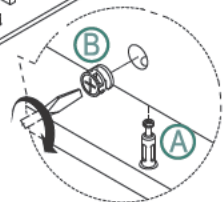
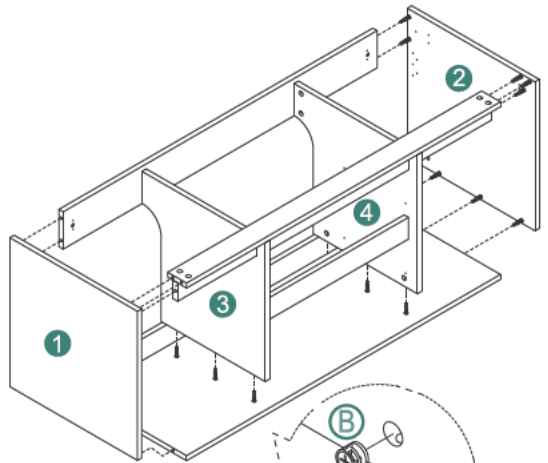
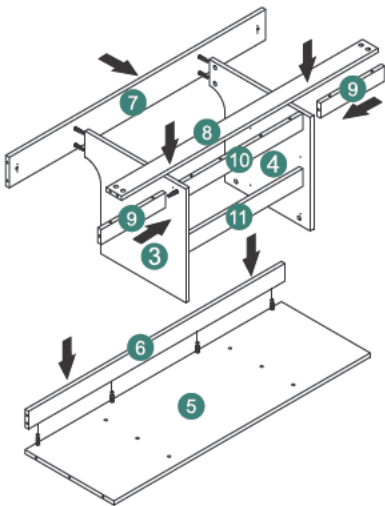

5

ASSEMBLY INSTRUCTIONS

3



C 56 pcs



I 6 pcs



H 2 pcs



K 2 pcs

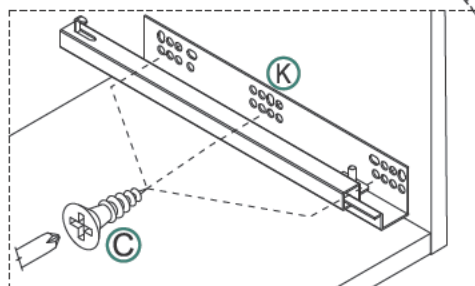
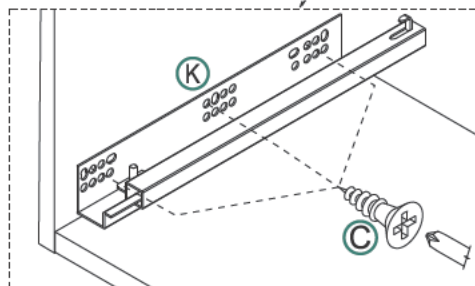
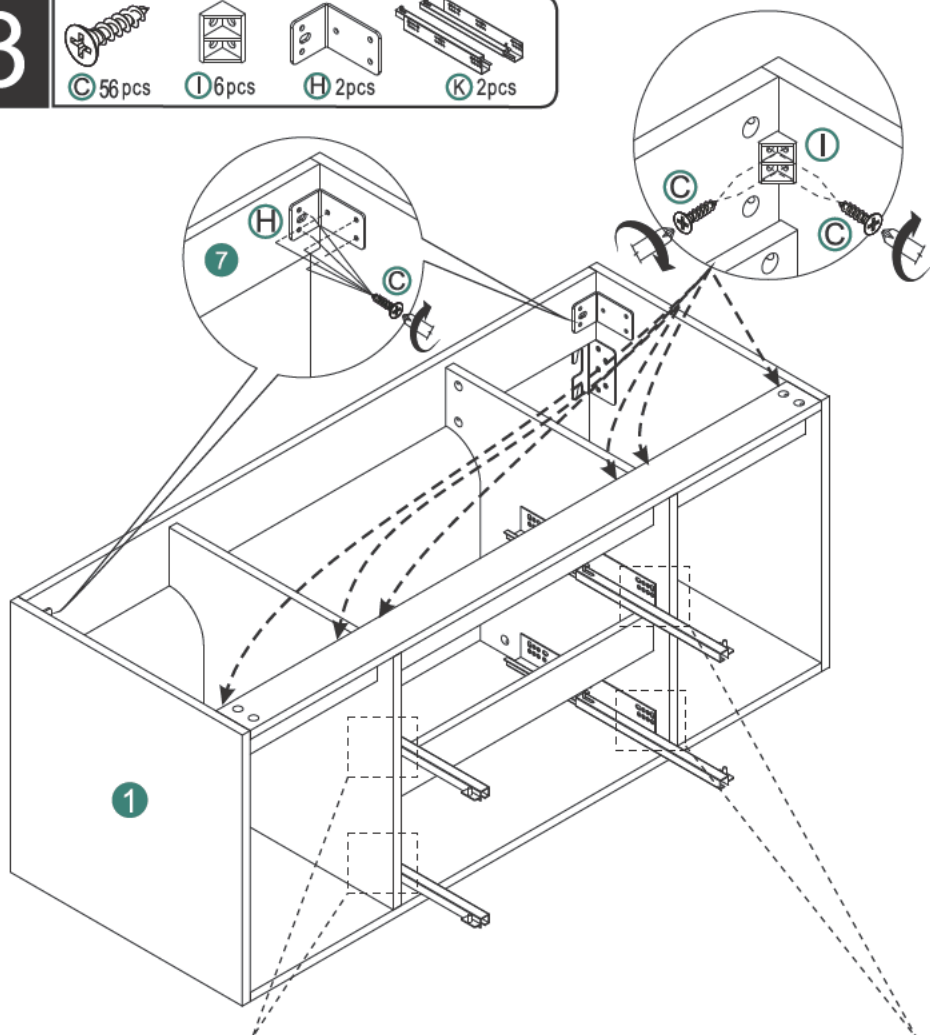

6

ASSEMBLY INSTRUCTIONS

4



B 32 pcs



D 4 pcs



J 1 pcs



C 21 pcs



L 12 pcs

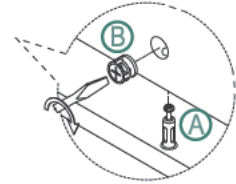
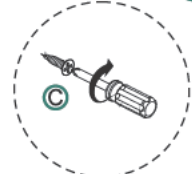
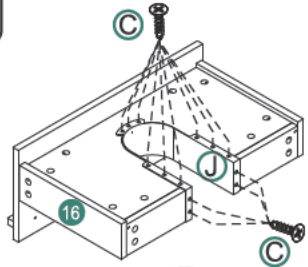
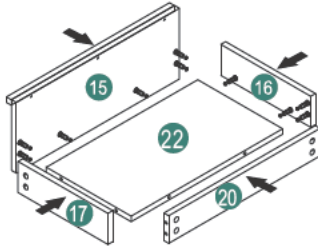
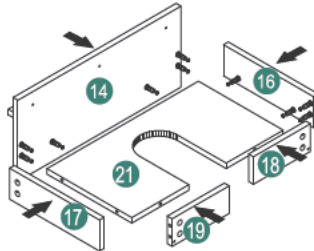
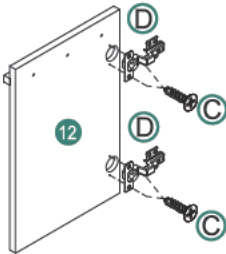
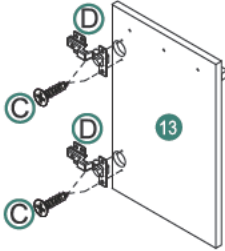

5



E 4 pcs



Bring your own tools

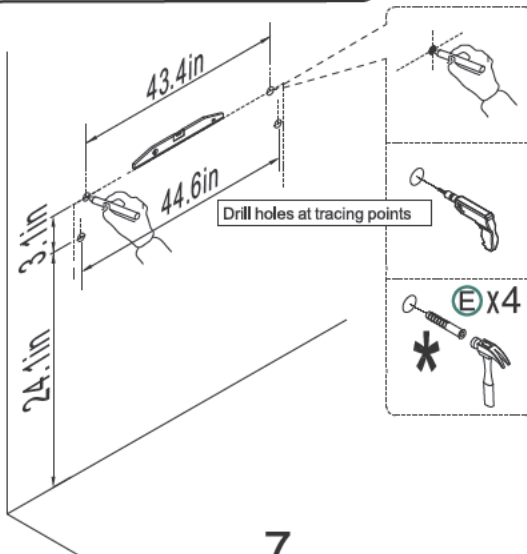

7

ASSEMBLY INSTRUCTIONS

6

 **C** 24pcs
 **F** 4pcs
 **G** 4pcs

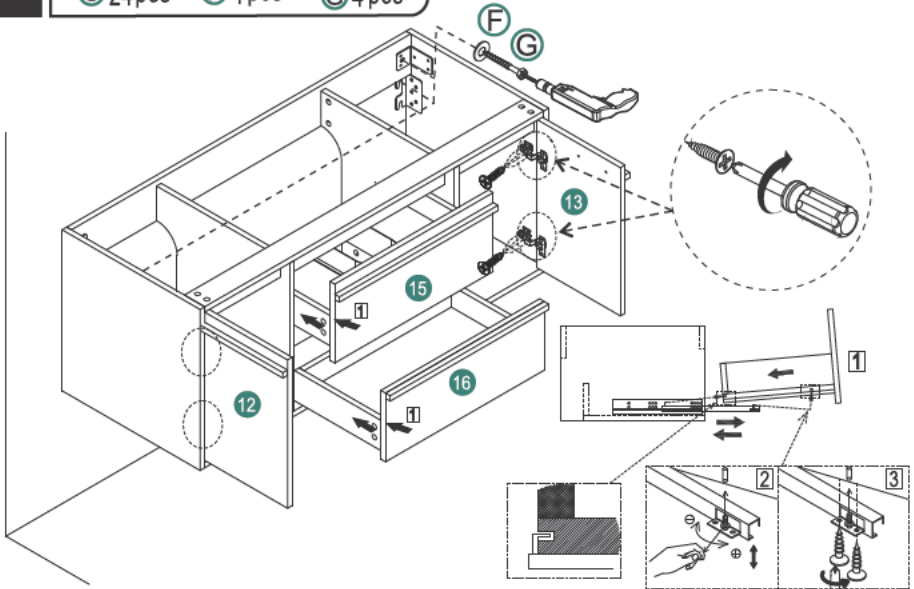

7

 **L** 8pcs
 **M** 1pcs

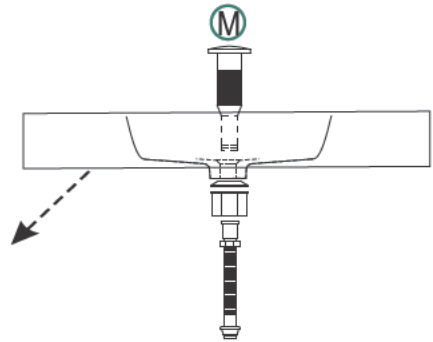
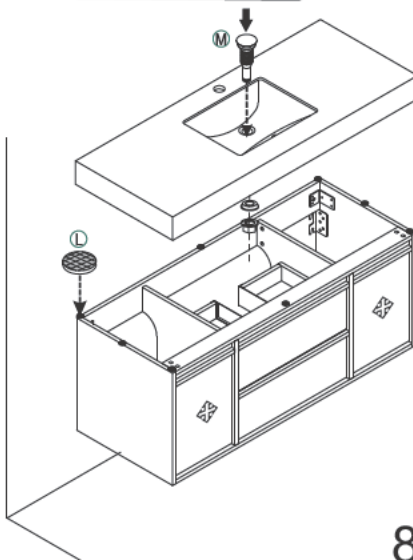

HOW TO ADJUST HINGES (if required)



DRAWERS REMOVAL & RE-INSTALLATION (if required)

REMOVAL

RE-INSTALLATION

8