

# HAPPINESS INSTALLATION

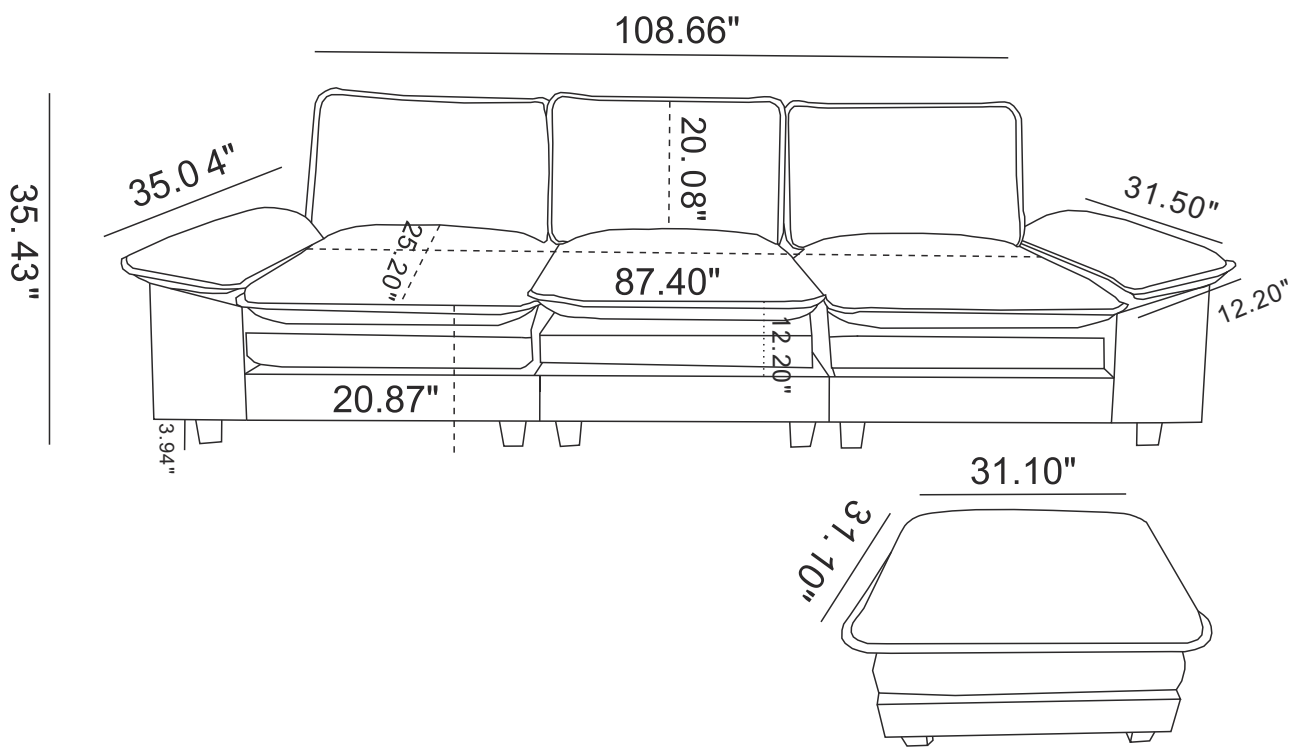

CAUTION

Parts are placed at the bottom of the product









# Assembly Instructions

Your sofa comes packaged in three boxes. Carefully remove all of components from the packaging and set aside for assembly.

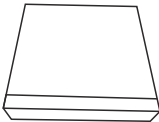

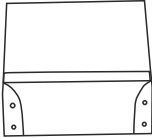







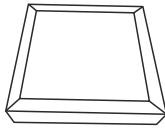
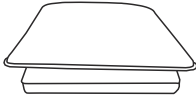
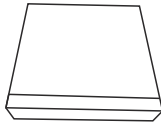

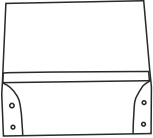
Package Contents

**CAUTION:**  
DO NOT use any sharp objects to open plastic wrapped components as damage to product or components may result .

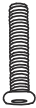

## BOX 1

|   |   |  |   |
|---|---|--|---|
|  |  |  |  |
| A x 2 Seat frame  | G x 2 Seat cushion  | D x 2 Backrest   | I x 2 Back cushion  |
|  |  |  |   |
| X x 1 Armrest bag(Left)   | Y x 1 Armrest bag(Right)  |  |   |

## BOX 2

|   |   |  |   |
|---|---|--|---|
|    |    |  |  |
| C x 1 Ottoman frame   | H x 1 Ottoman cushion   | A x 1 Seat frame   | G x 1 Seat cushion  |
|    |    |  |  |
| D x 1 Backrest  | I x 1 Backcushion   | S x 1 Back Cover   | M x 16 Leg  |
|    |   |   |  |
| O x 20 Bolt M8*60mm   | P x 4 Bolt M8*80mm  | L x 16 Gasket  | N x 28 Flat Washer  |
|  |  |  |   |
| Q x 4 Butterfly Nut   | R x 1 Open Wrench M6  |  |   |

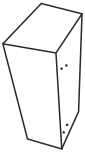
## BOX 3

|   |   |
|---|---|
|  |  |
| E x 1 Left armrest  | F x 1 Right armrest   |

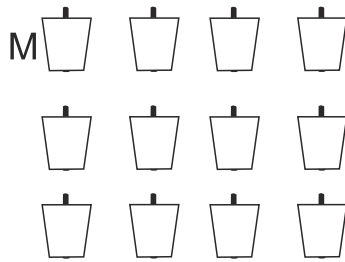
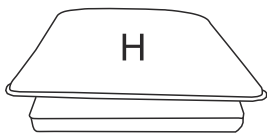
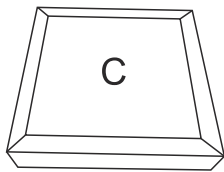
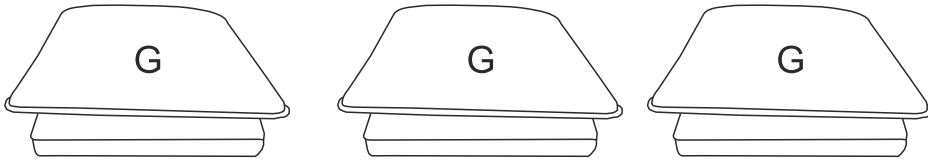
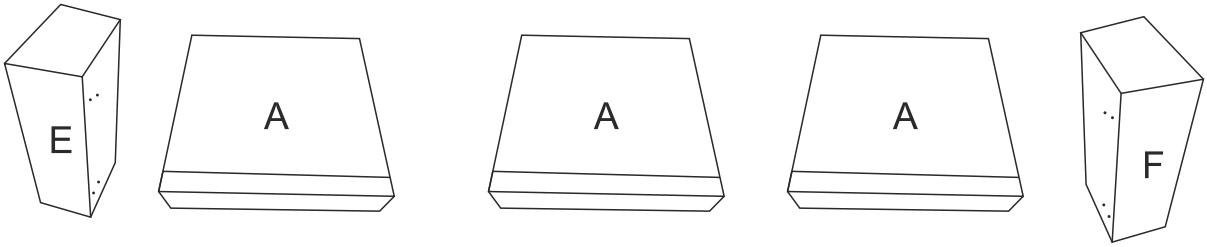
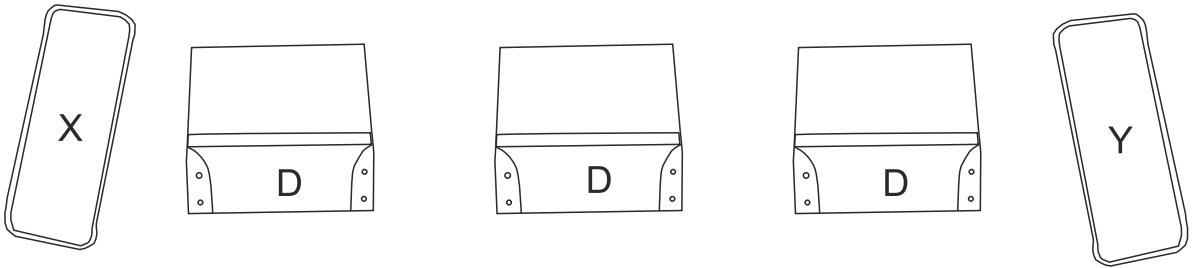
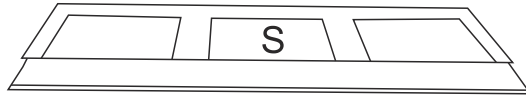
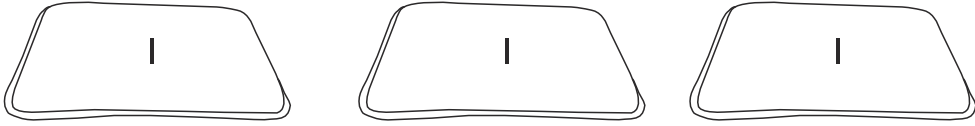

STEP 1: Connect Left armrest (E) & Seat frame (A) with Bolts (O) and Washers(N).

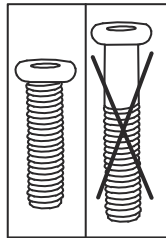
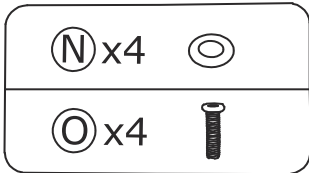
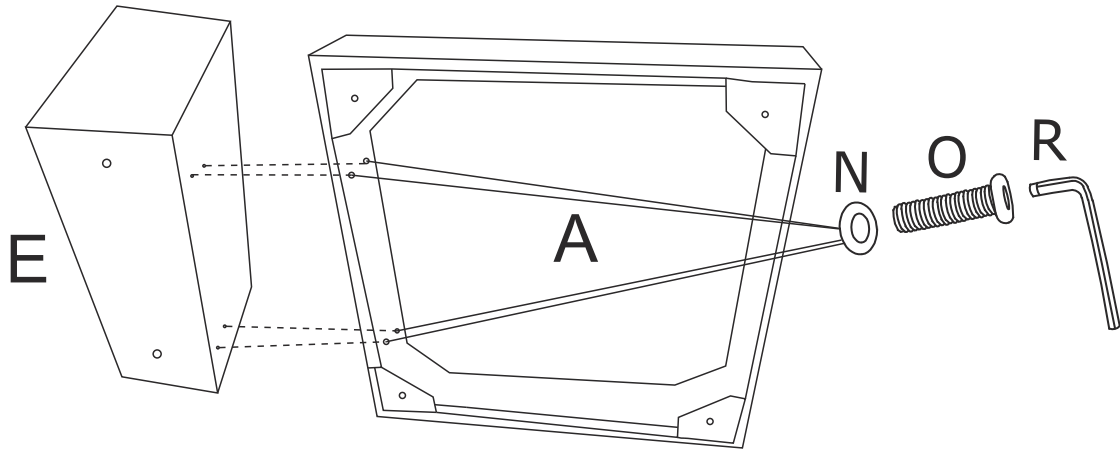

STEP 2: Connect Right armrest (F) & Seat frame (A) with Bolts (O) and Washers(N).

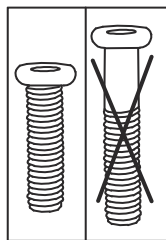
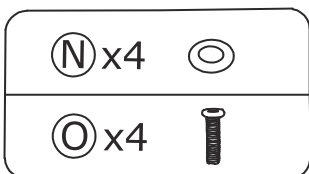
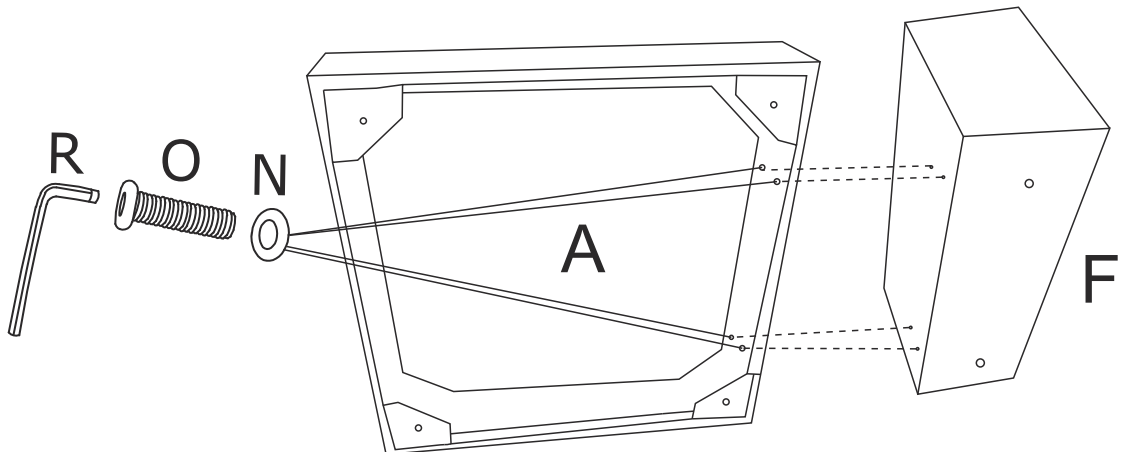

STEP 3: Connect Seat frame (A) and parts from step 1 & step 2 with Bolts (P), Washers (N) and Butterfly nuts (Q).

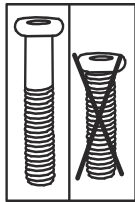
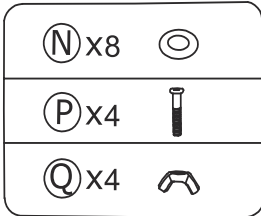
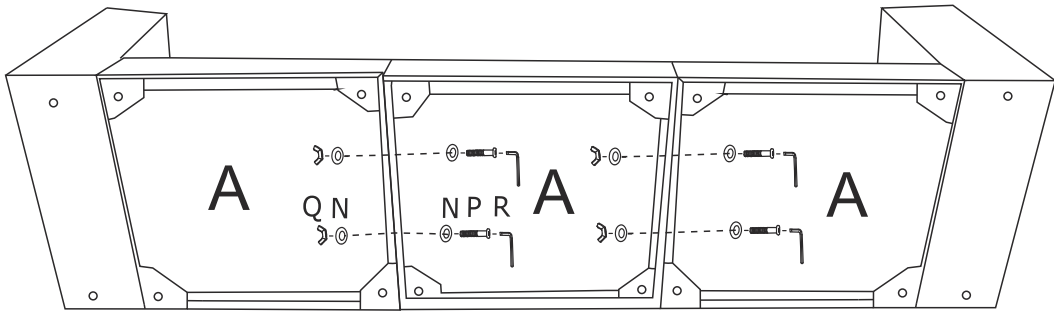

STEP 4: Install sofa legs, screw in Legs (M) and Gaskets (L).

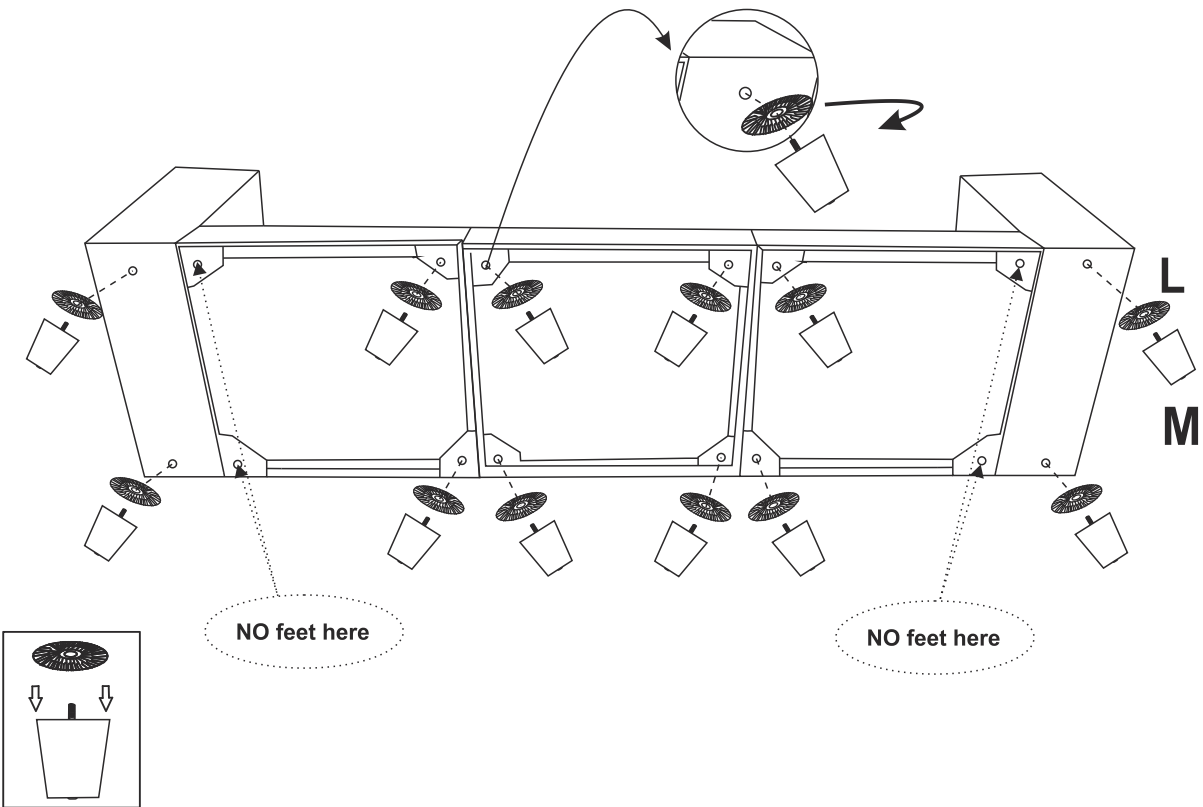

STEP 5: Install ottoman legs, screw in Legs (M) and Gaskets (L).

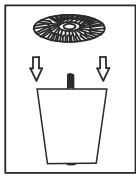
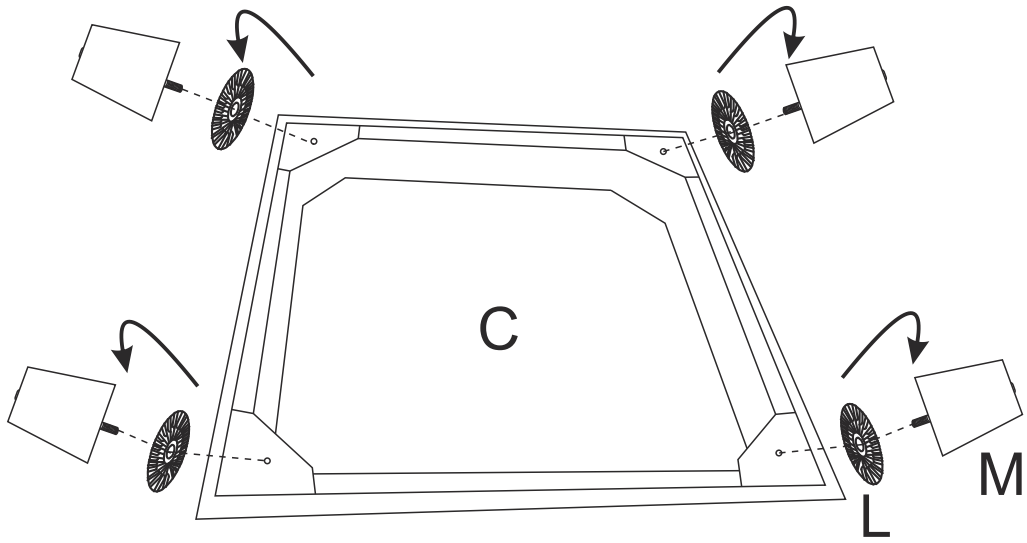

STEP 6: Line up the holes in the Backrest(D) with corresponding holes on the frame. Insert Bolts (O) and Washers (N) securely after they have all been placed.

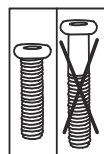
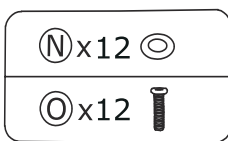
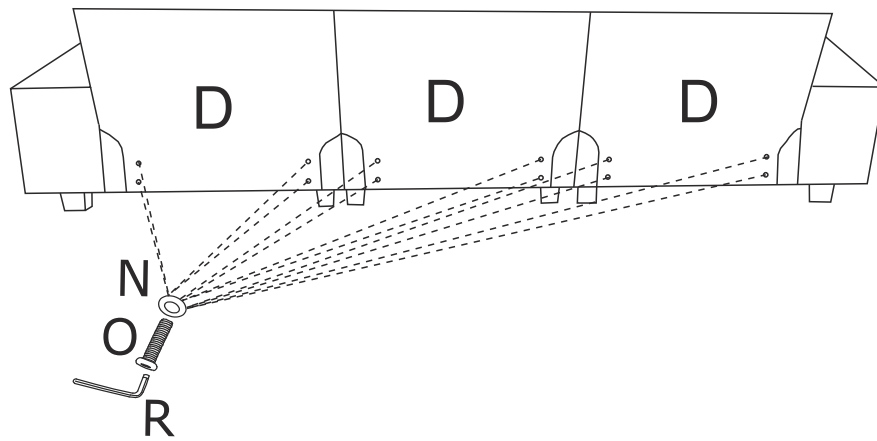

STEP7: Put the back cover on the back fame.

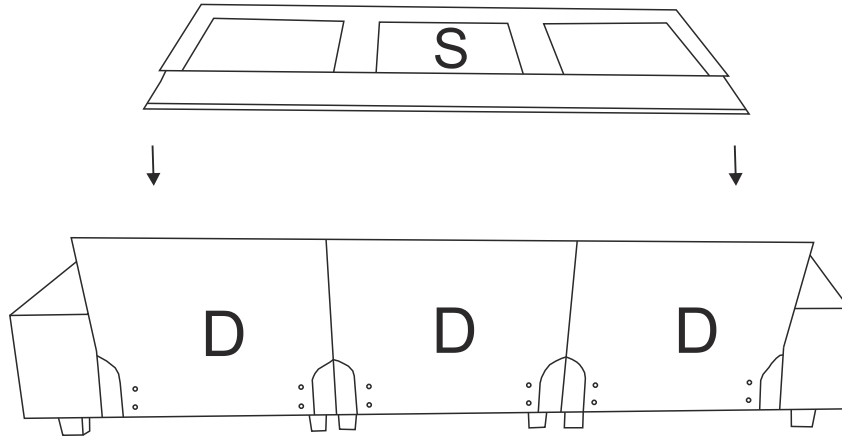

STEP 8: Use scissors to open all the vacuum sealed cushions. It may take 48-72hrs to fully expand back to its original shape.

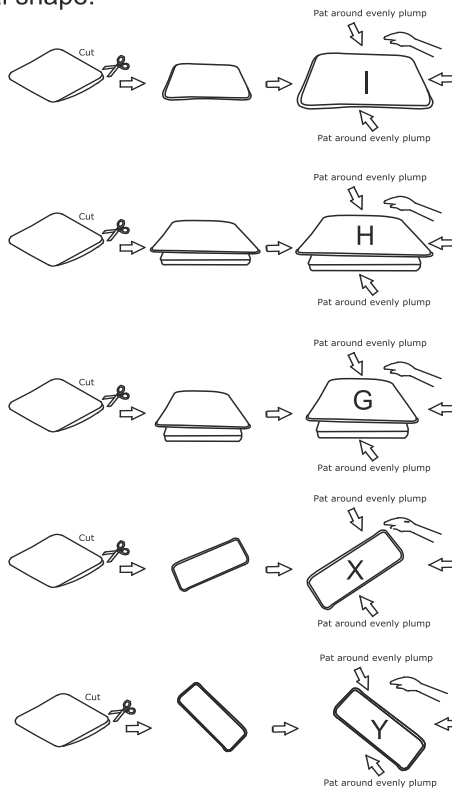

STEP 9: Add the cushions and you're done.

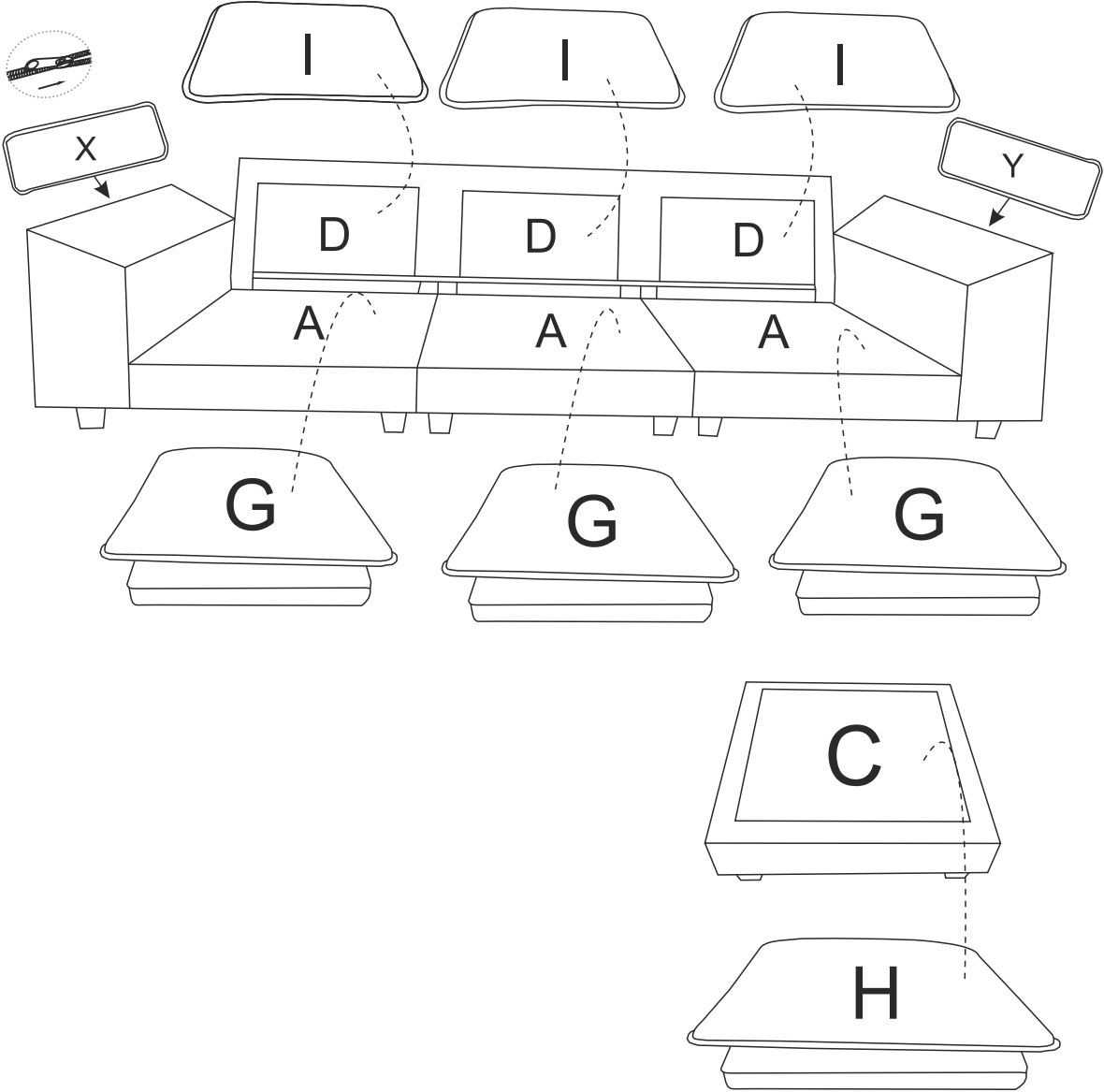

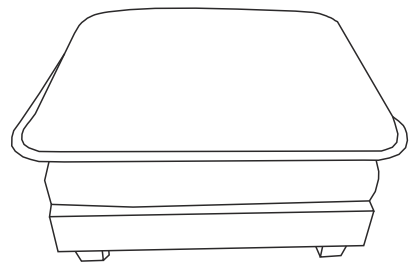
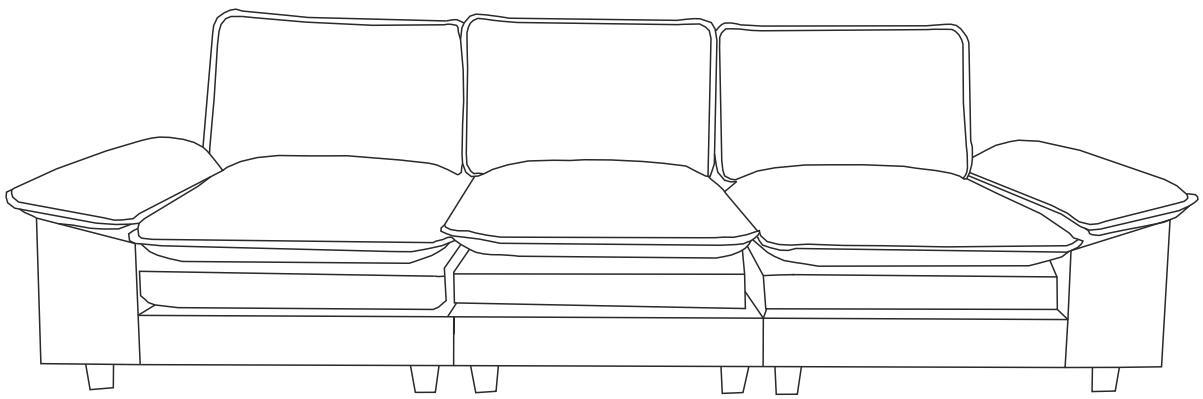

## Warnings

1. Please check if the components of the chair are all included and can be used normally.
2. Assemble all components according to the instruction correctly before you connect the chair to the power.
3. Please DO NOT sit on the armrests or footrest to eliminate the risk of tipping over.
4. If the chair is damaged or doesn't match the website description, please send clear pictures of the product and label of the carton to our service team for further help.
5. If the recliner doesn't work, you may try the following measures for self-checking firstly:
  - a) Check if all the cables are connected;
  - b) Check if the light of transformer is on.If the chair still doesn't work, please feed the information back to our customer service in time and we'll help you solve the matter as soon as possible.
6. If you have any questions with the product, please contact us by:

