

Assembly Guide

Tip!

Do check for all the components and screws listed in this guide before putting things together. If any part is missing, contact us for the missing part.

Return Policy

Your satisfaction is our top priority. If our product fails to satisfy you, please let us know how we can make things right for you. Our trained customer care team can handle most concerns and assist you with any questions you may have. Simply shoot them a message with your order number and question. To be eligible for a full-refund return, the item must be in pristine condition, in the original packaging, with all of the shipped components intact and not yet assembled, and with the item's unique proof of purchase.

Trouble shooting:

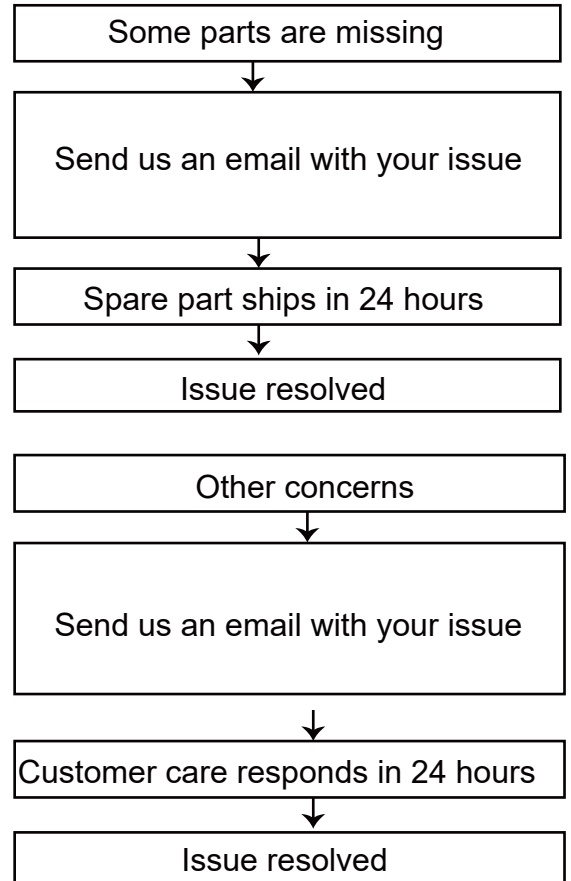

We run our own manufacturer, so rest assured about the quality consistency.

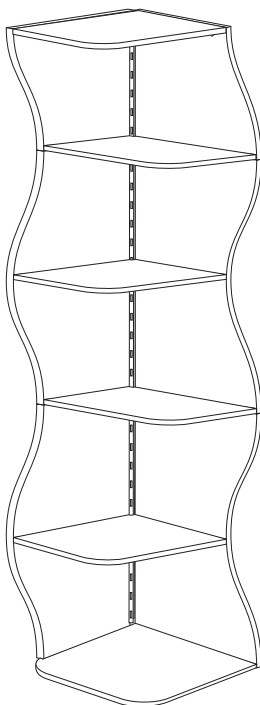

Item Description: Corner Shelf

Montageanleitung

Tipp!

ÜBERPRÜFEN Sie alle in dieser Anleitung aufgeführten Komponenten und Schrauben, bevor Sie die Bauteile zusammenbauen. Sollte ein Bauteil fehlen, kontaktieren Sie uns um Ersatz zu erhalten.

Rückgaberrichtlinie

Ihre Zufriedenheit ist unsere oberste Priorität. Wenn Sie mit unserem Produkt nicht zufrieden sind, lassen Sie uns bitte wissen, wie wir das Problem für Sie lösen können. Unser geschultes Kundenbetreuungsteam kann die meisten Anliegen klären und Ihnen bei all Ihren Fragen weiterhelfen. Senden Sie uns einfach eine Nachricht mit Ihrer Bestellnummer und Ihrer Anfrage. Um eine vollständige Rückerstattung zu erhalten, muss der Artikel in einwandfreiem Zustand sein und sich in der Originalverpackung mit allen gelieferten und noch nicht zusammengebauten Komponenten befinden. Zudem ist ein eindeutiger Kaufnachweis erforderlich.

Problemlösung:

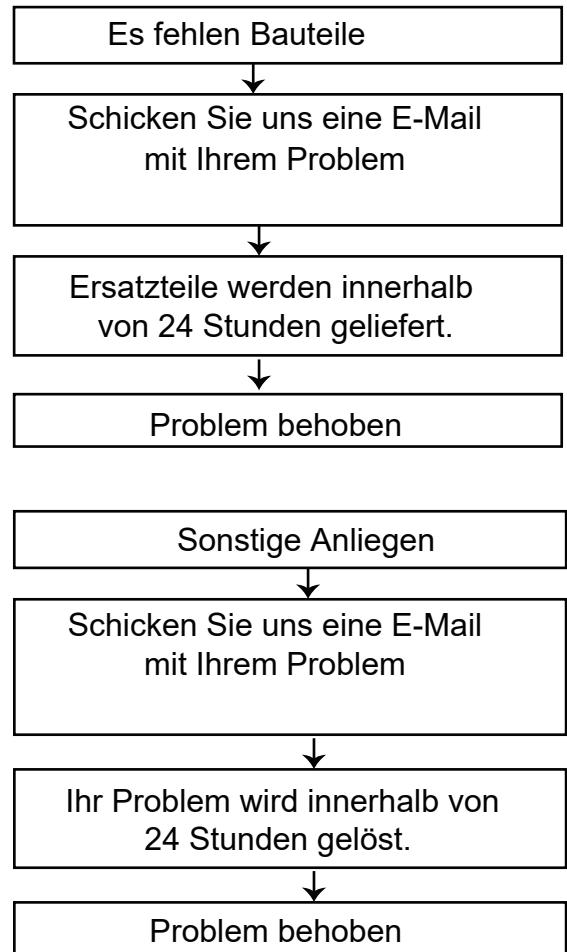

Wir stellen unsere Artikel selbst her, sodass Sie sich auf gleichbleibende Qualität verlassen können.

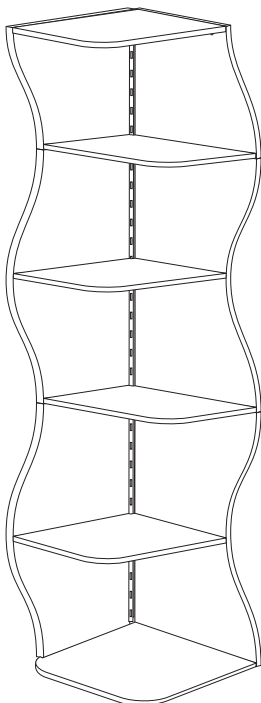

Item Description: Eckregal

Guida all'assemblaggio

Suggerimento!

Controllare tutti i componenti e le viti elencati in questa guida prima di assemblare il tutto. Se manca qualche parte, contattaci per le parti mancanti.

Politica di reso

La vostra soddisfazione è la nostra massima priorità. Se il nostro prodotto non ti soddisfa, faccelo sapere e ti aiuteremo a risolvere il problema. Il nostro team di assistenza clienti qualificato può gestire la maggior parte delle preoccupazioni e assisterti per qualsiasi domanda tu possa avere. Inviaci semplicemente un messaggio con il tuo numero d'ordine e la tua richiesta. Per essere idoneo a un reso con rimborso completo, l'articolo deve essere in ottime condizioni, nella confezione originale, con tutti i componenti intatti e non ancora assemblati, e con una prova d'acquisto valida.

Risoluzione dei problemi:

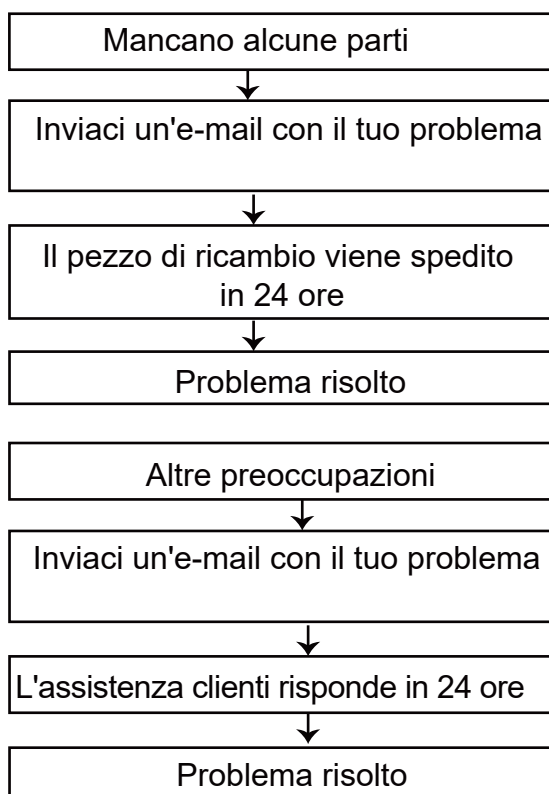

Gestiamo direttamente il nostro produttore, quindi puoi essere sicuro della qualità costante.

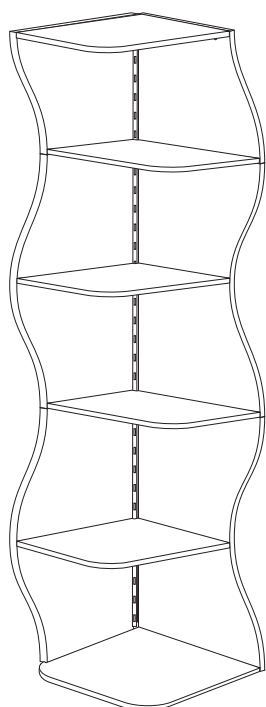

Descrizione dell'articolo: Scaffale d'angolo

Guide de montage

Attention !

Vérifiez la présence de l'ensemble des éléments et vis énumérés dans ce guide avant de procéder au montage. Si une pièce venait à manquer, envoyez-nous un e-mail pour nous en informer.

Politique de retour

Votre satisfaction est notre priorité absolue. Si notre produit ne vous donne pas entière satisfaction, n'hésitez pas à nous faire savoir ce que nous pouvons faire pour améliorer la situation. Notre équipe d'assistance à la clientèle qualifiée est en mesure de résoudre la plupart de vos problèmes et de répondre à toutes vos questions. Il vous suffit de leur envoyer un message en indiquant votre numéro de commande et votre question. Pour pouvoir bénéficier d'un remboursement intégral, l'article doit être en parfait état, dans son emballage d'origine, avec tous les composants expédiés intacts et non encore assemblés, et avec la preuve d'achat de l'article"

Dépannage :

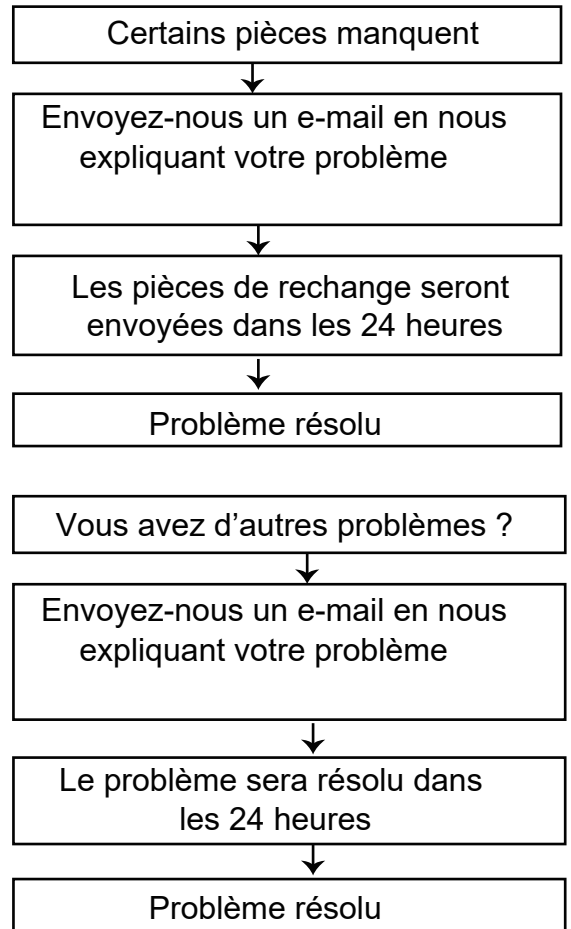

Nous assurons notre propre fabrication donc soyez assuré de bénéficier d'une qualité constante.

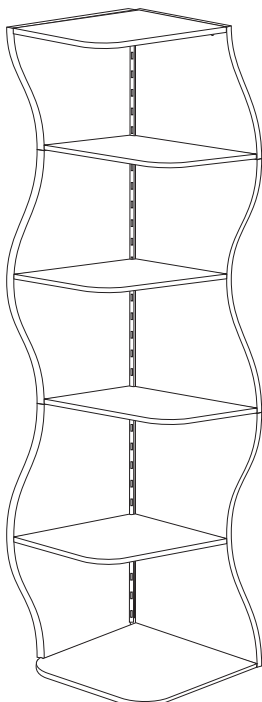

Item Description: Étagère d'angle

Guía de montaje

Consejo!

Verifique todos los componentes y tornillos enumerados en esta guía antes de ensamblar todo. Si falta alguna pieza, contáctanos para las piezas faltantes.

Política de devoluciones

Su satisfacción es nuestra máxima prioridad. Si nuestro producto no le satisface, háganoslo saber y le ayudaremos a resolver el problema. Nuestro equipo de atención al cliente capacitado puede manejar la mayoría de las inquietudes y ayudarle con cualquier pregunta que pueda tener. Simplemente envíenos un mensaje con su número de pedido y su consulta. Para ser elegible para una devolución con reembolso completo, el artículo debe estar en impecable estado, en su embalaje original, con todos los componentes intactos, no ensamblado y con un comprobante de compra válido.

Solución de problemas:

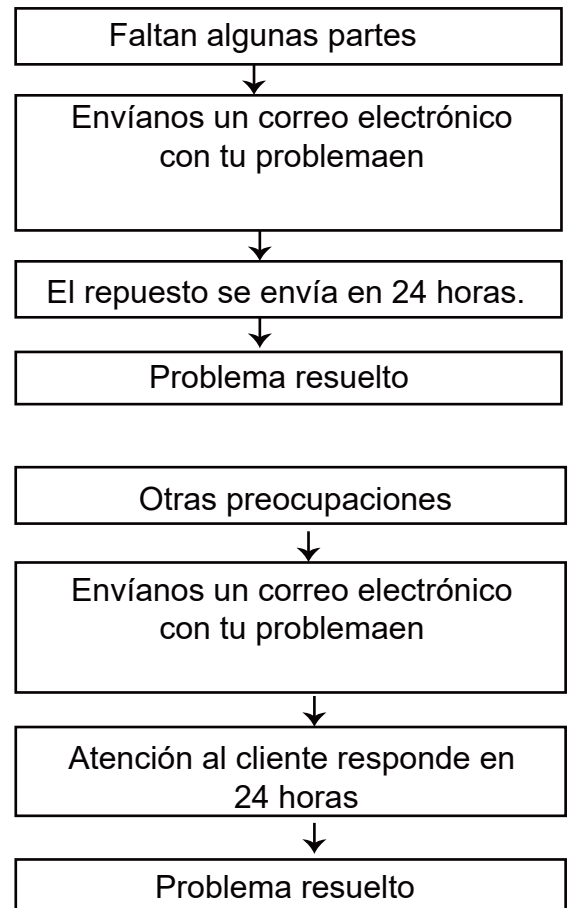

Gestionamos directamente con nuestro fabricante, así que puede estar seguro de la consistencia de la calidad.

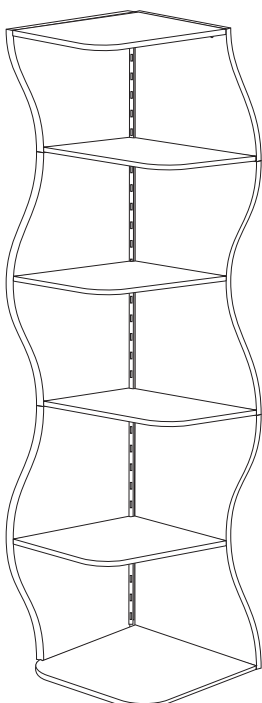

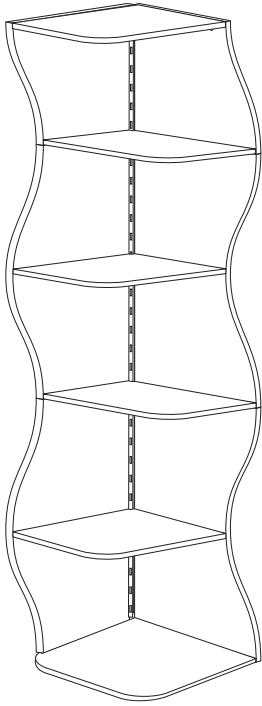

Descripción del artículo: Estante de esquina



Corner Shelf

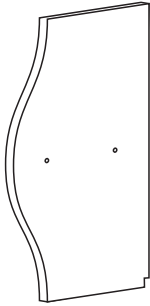
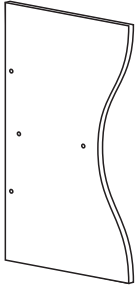
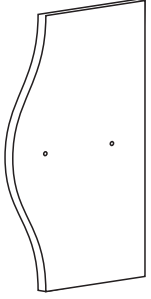
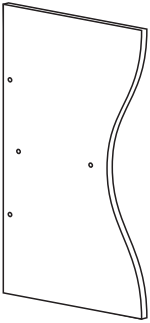
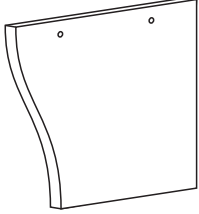
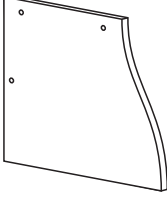
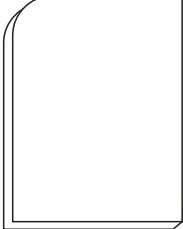
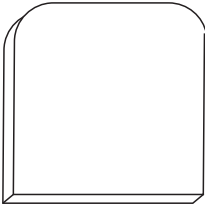
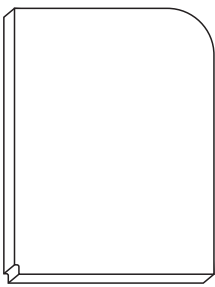

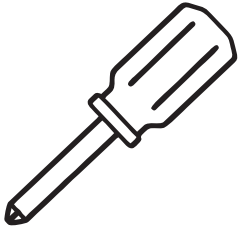
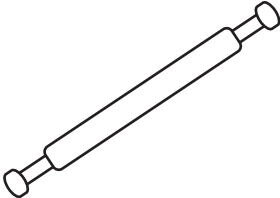
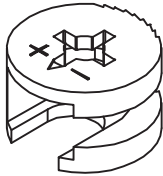
<p>1</p>		<p>1pc</p>	<p>2</p>		<p>1pc</p>
<p>3</p>		<p>1pc</p>	<p>4</p>		<p>1pc</p>
<p>5</p>		<p>1pc</p>	<p>6</p>		<p>1pc</p>
<p>7</p>		<p>1pc</p>	<p>8</p>		<p>1pc</p>
<p>9</p>		<p>4pcs</p>			

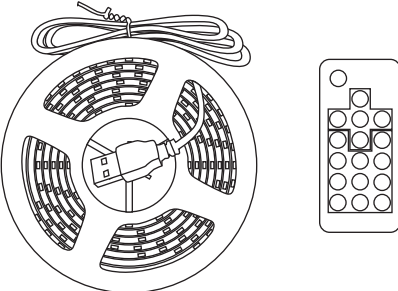
<p>A</p>		<p>1pc</p>
<p>B</p>		<p>8pcs</p>
<p>C</p>		<p>16pcs</p>
<p>D</p>		<p>29pcs</p>
<p>E</p>		<p>1pc</p>

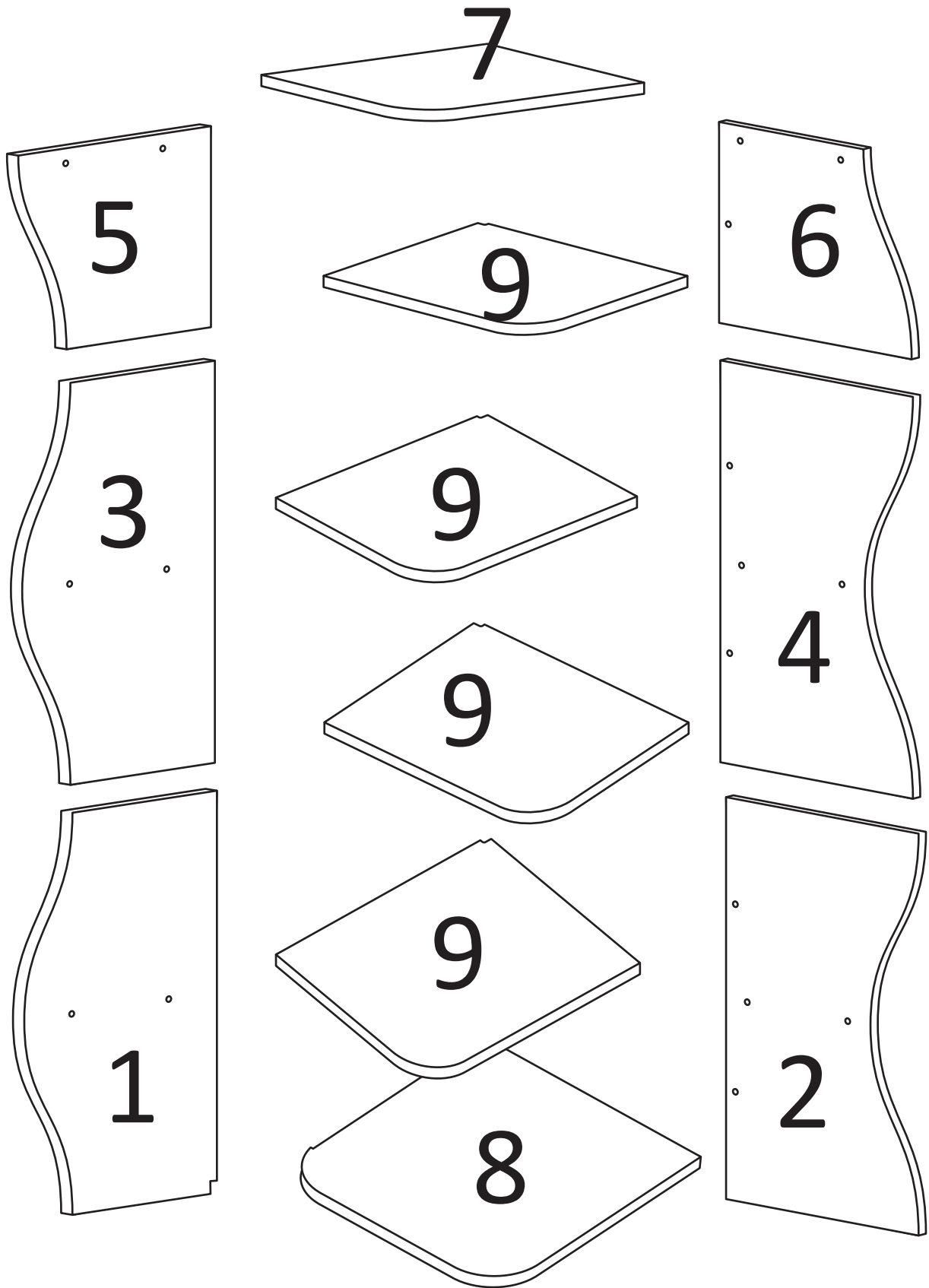

Step 1

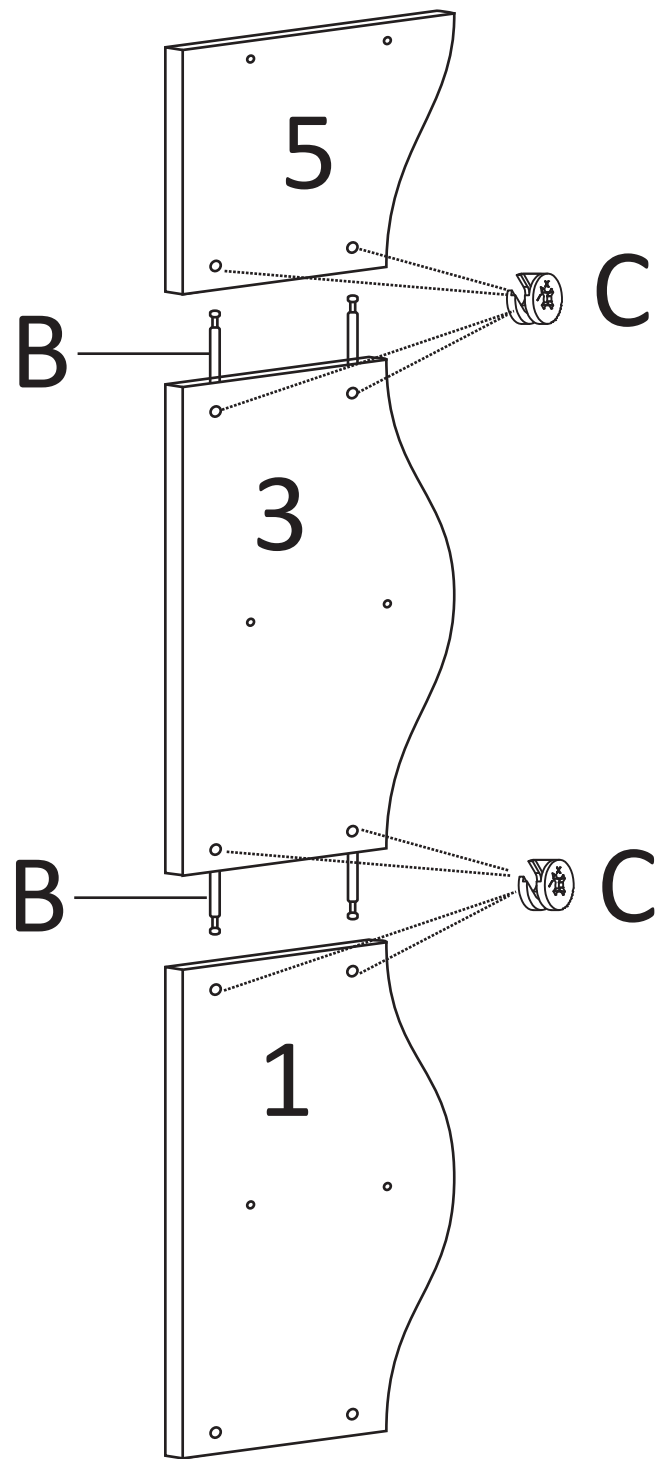
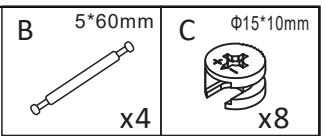

Step 2

B 5*60mm
x4

C $\phi 15 \times 10$ m
x8

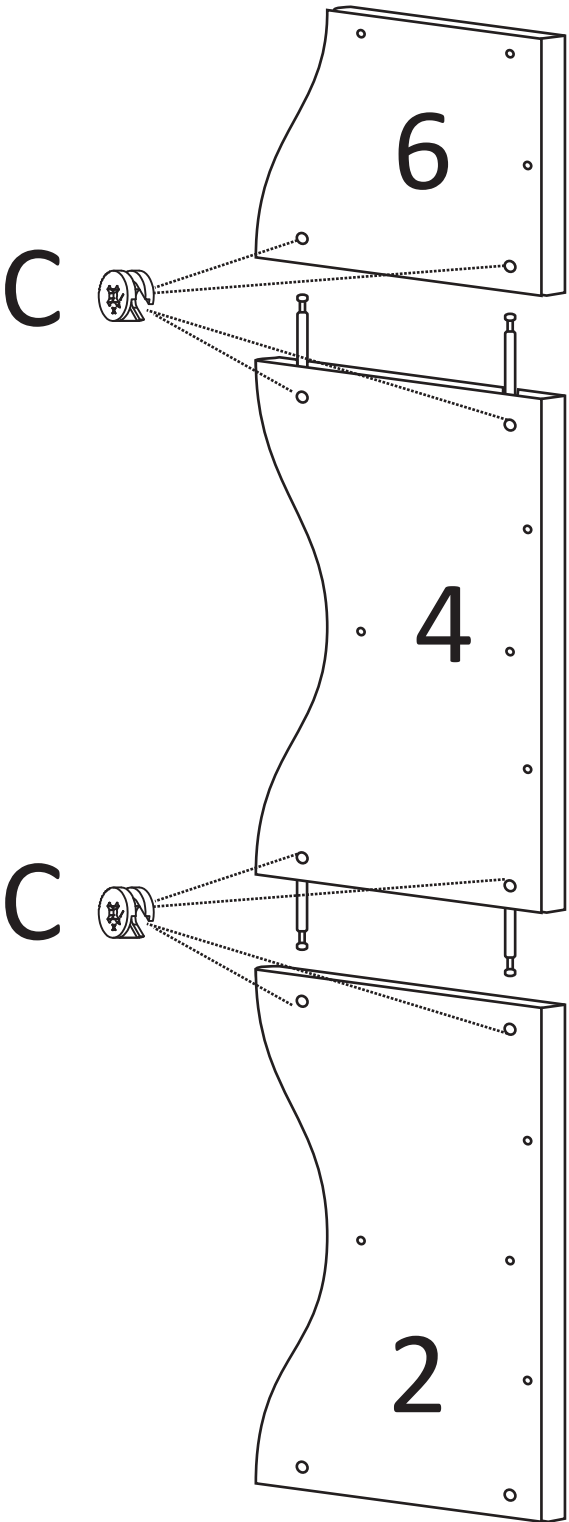

Step 3

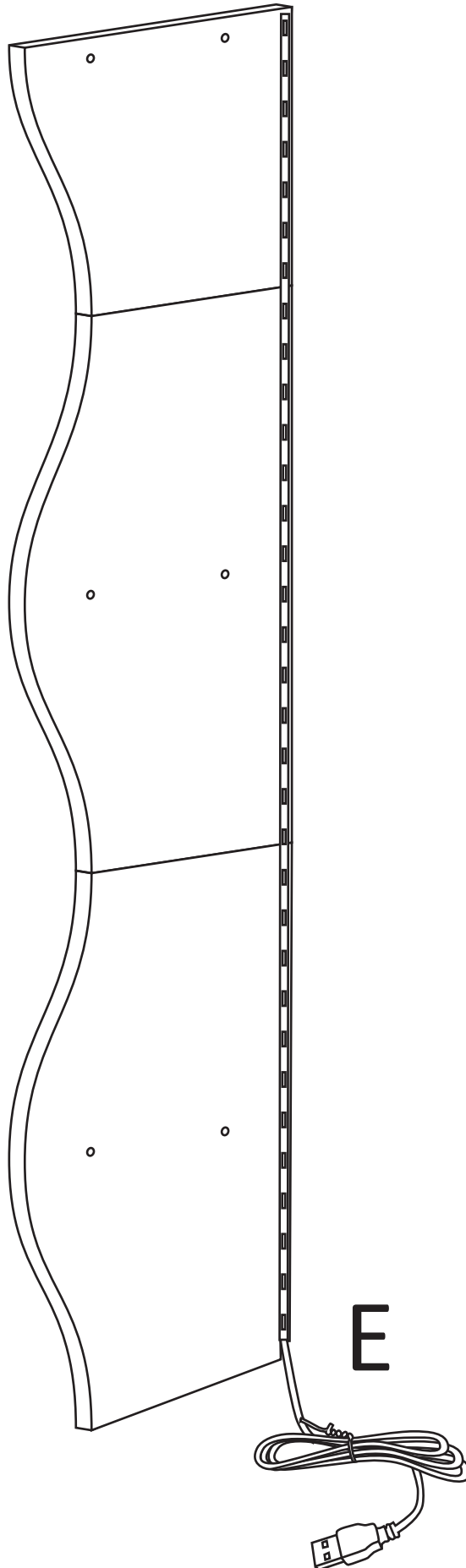
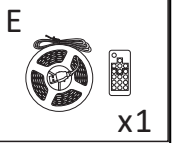

Step 4

D 4*30mm



x5

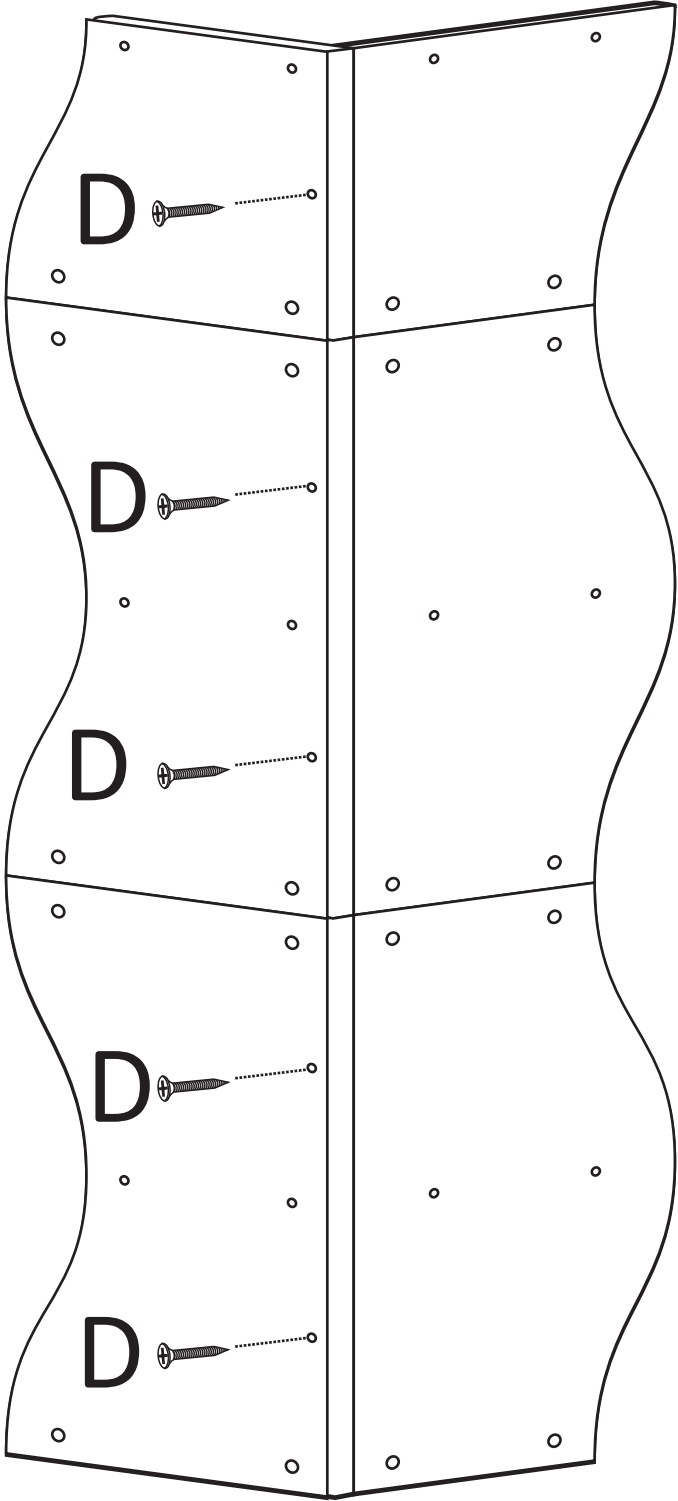

Step 5

D 4*30m



x4

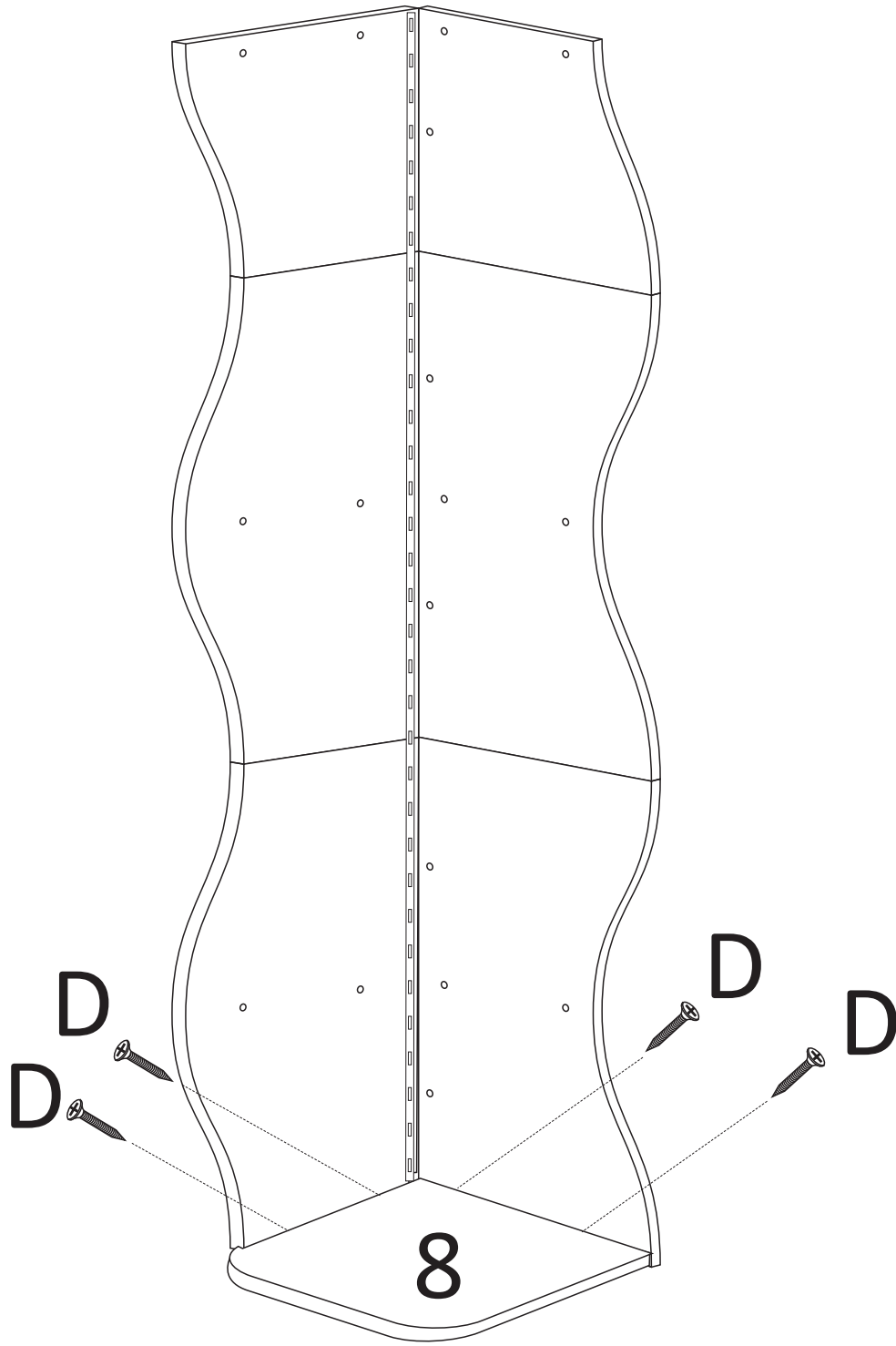

Step 6

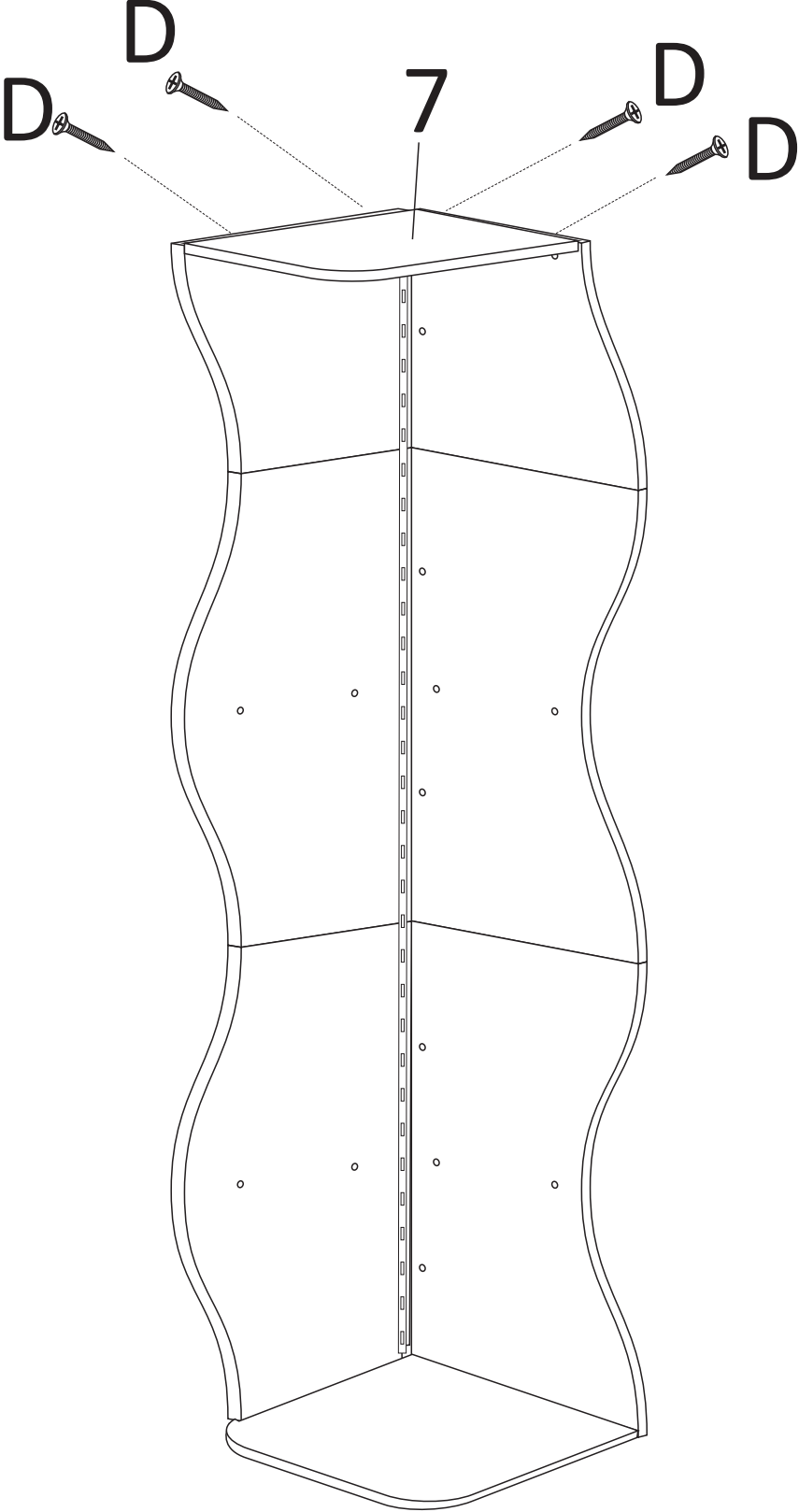

Step 7

D 4*30m



x16

