

ASSEMBLY INSTRUCTION

MF320571

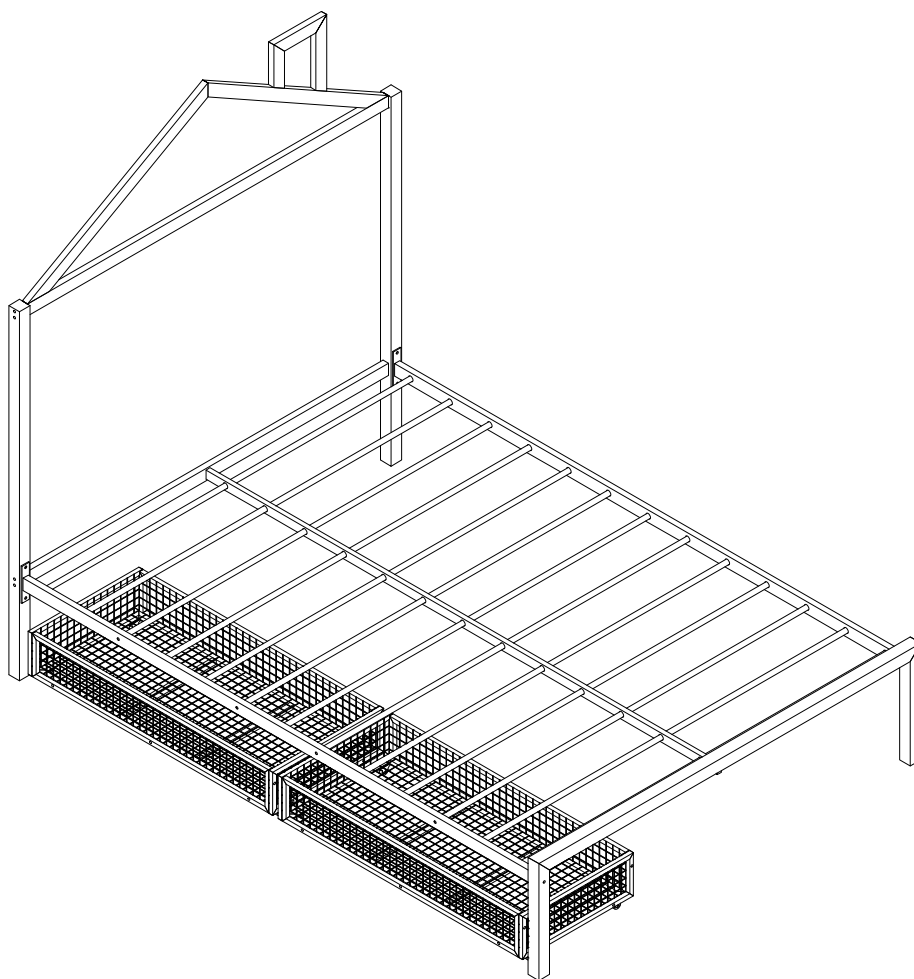

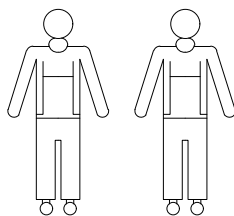

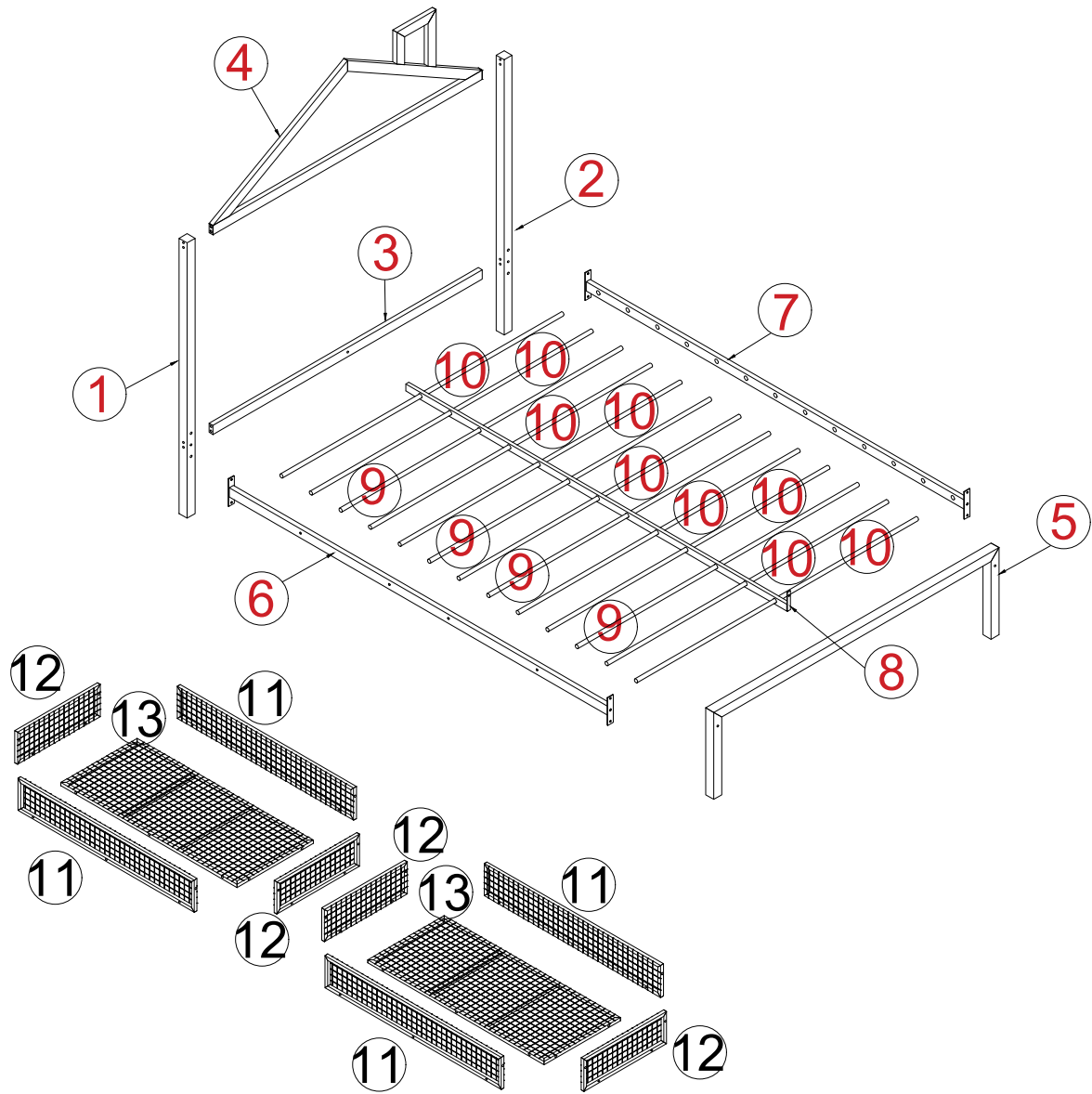

Minimum no. 2 of people
recommended to assemble
this product: Approx.
assembly time: 60 mins





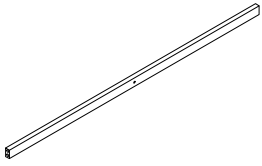
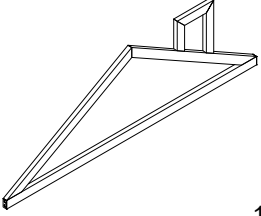
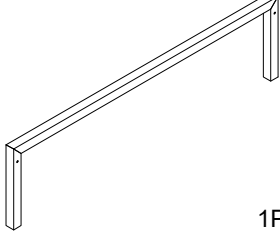
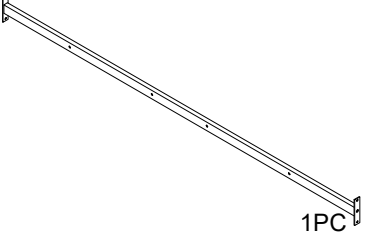
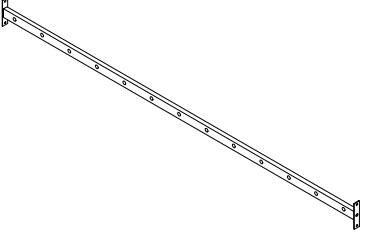
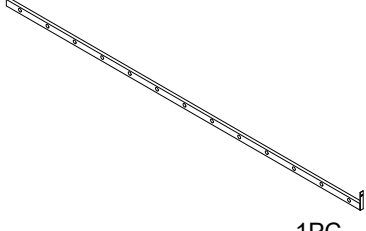
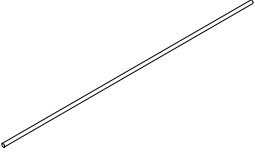
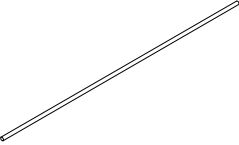
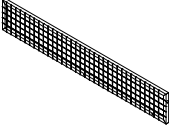

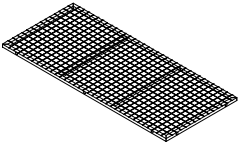







PART LIST MF320571

<p>1</p>  <p>1PC</p>	<p>2</p>  <p>1PC</p>	<p>3</p>  <p>1PC</p>
<p>4</p>  <p>1PC</p>	<p>5</p>  <p>1PC</p>	<p>6</p>  <p>1PC</p>
<p>7</p>  <p>1PC</p>	<p>8</p>  <p>1PC</p>	<p>9</p>  <p>4PCS</p>
<p>10</p>  <p>9PCS</p>	<p>11</p>  <p>4PCS</p>	<p>12</p>  <p>4PCS</p>
<p>13</p>  <p>2PCS</p>		

HARDWARE LIST MF320571

<p>A</p>  <p>12PCS M$\frac{1}{4}$"X55</p>	<p>B</p>  <p>1PC M$\frac{1}{4}$"X35</p>	<p>C</p>  <p>28PCS M$\frac{1}{4}$"X25</p>	<p>D</p>  <p>17PCS M$\frac{1}{4}$"X15</p>
<p>E</p>  <p>4PCS #40x40x16</p>	<p>F</p>  <p>15x20x40H 8 PCS</p>	<p>G</p>  <p>M4x15 16 PCS</p>	<p>H</p>  <p>1PC M4X23X57</p>

STEP 1

A	E
	
M $\frac{1}{4}$ 'x55	#40x40x16
8 PCS	2 PCS

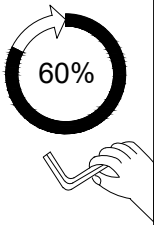
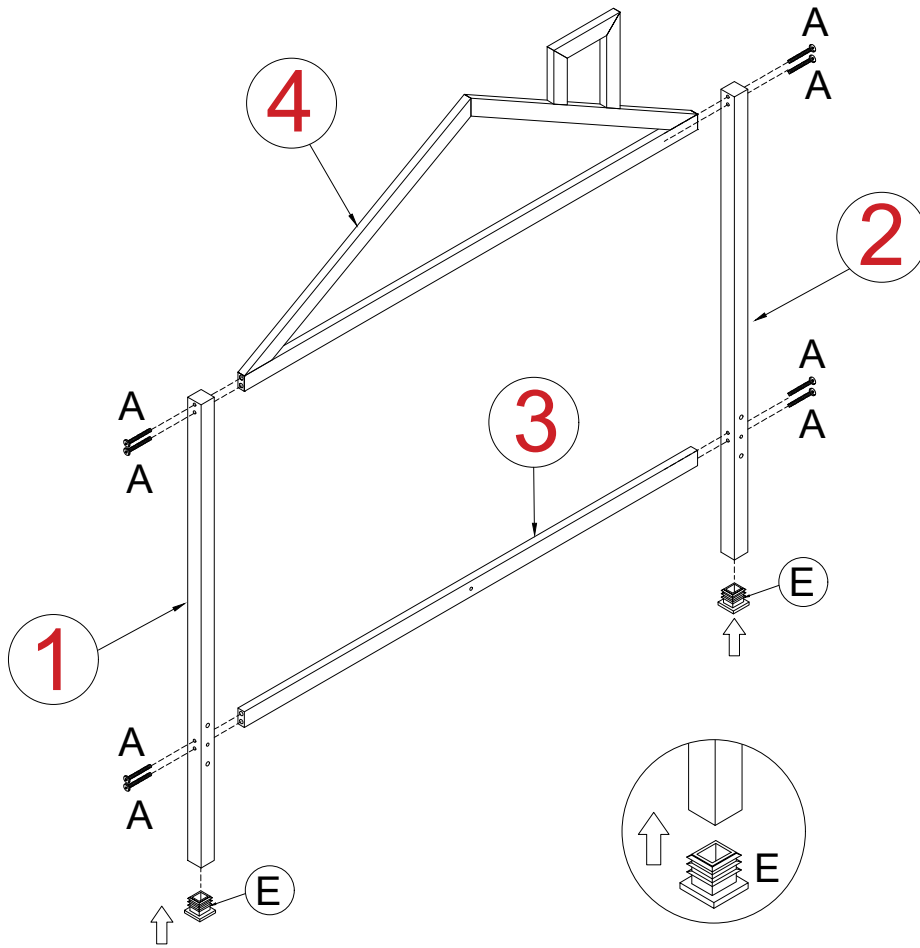



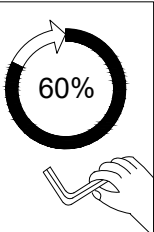
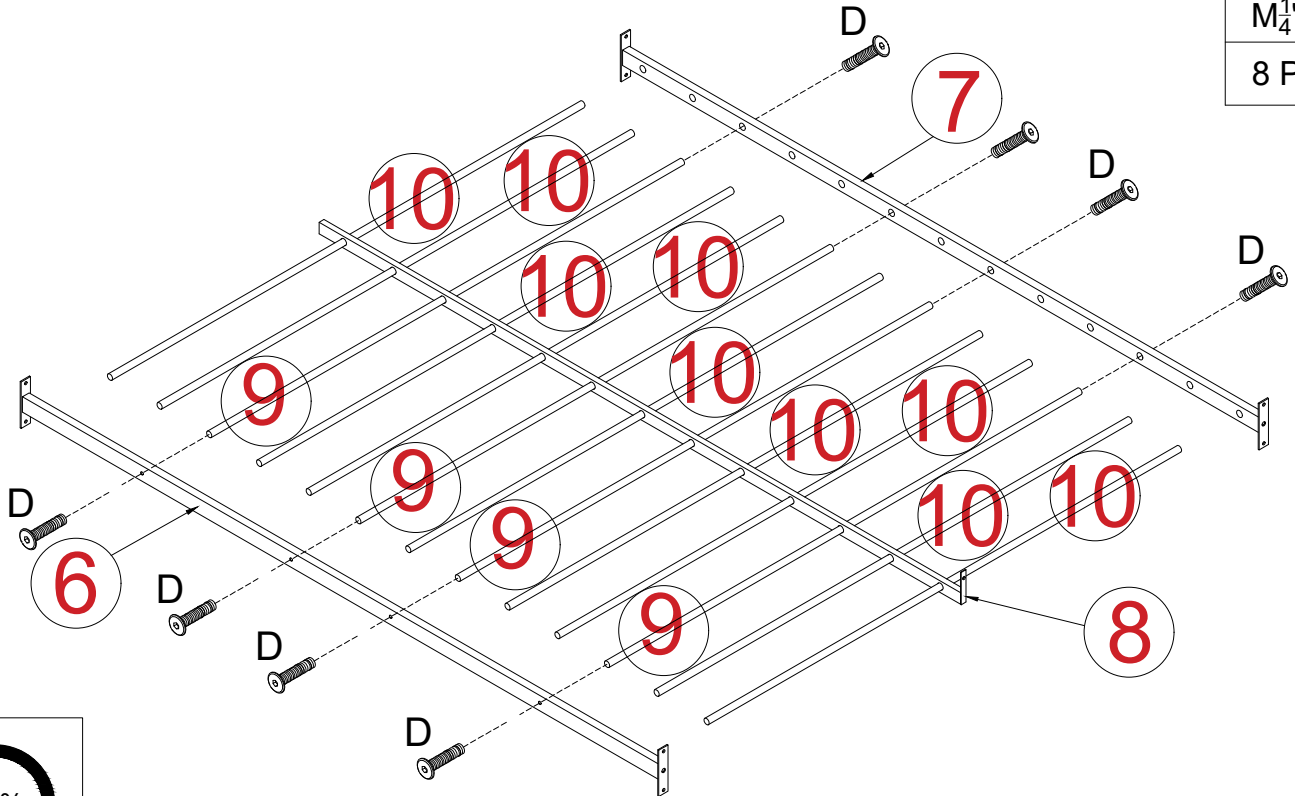

STEP 2

D

M $\frac{1}{4}$ 'x15
8 PCS

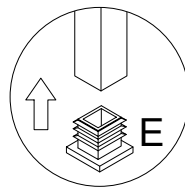
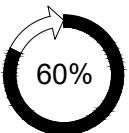
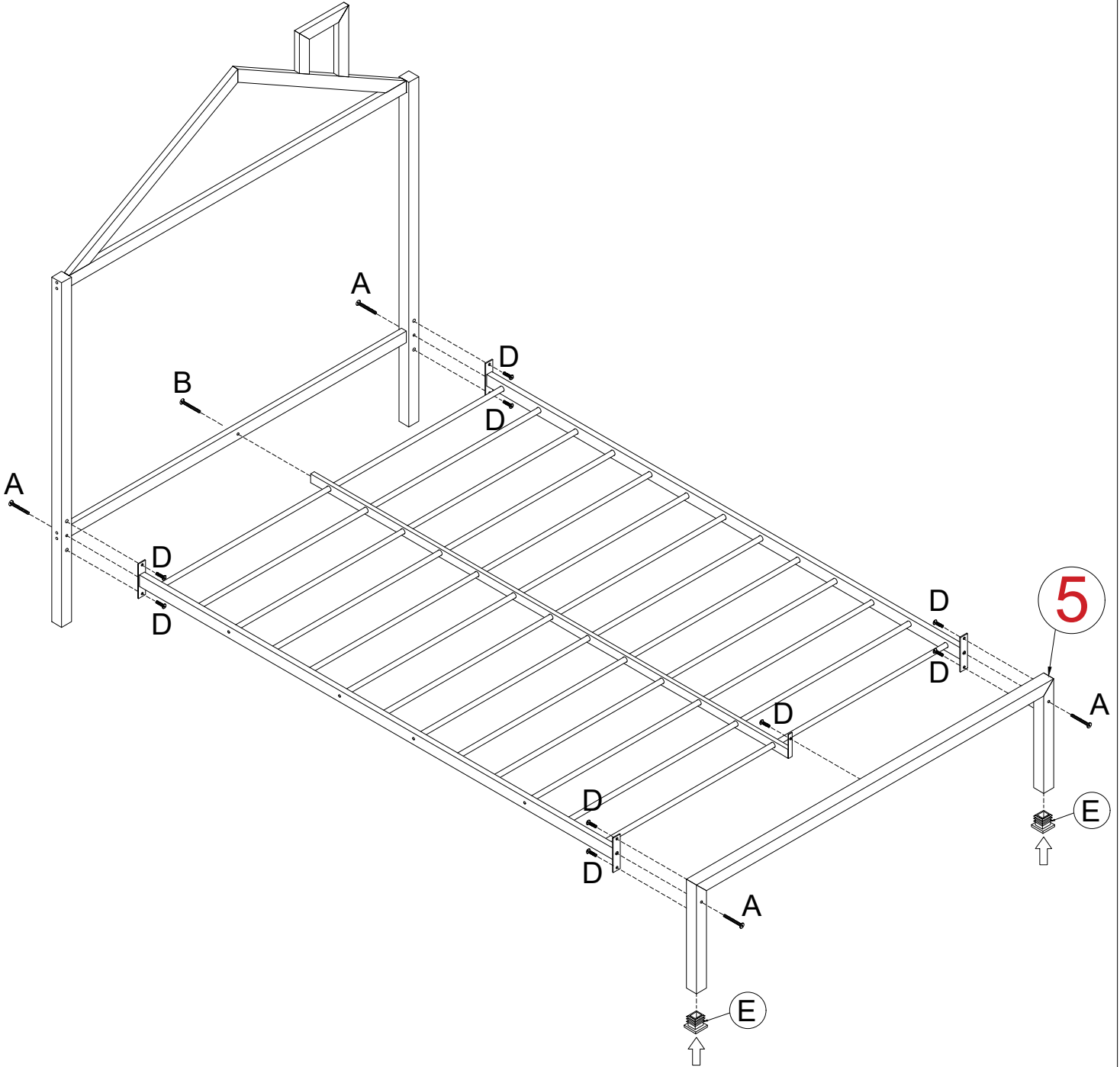

STEP 3

A	B	D	E
			
M $\frac{1}{4}$ "x55	M $\frac{1}{4}$ "x35	M $\frac{1}{4}$ "x15	#40x40x16
4 PCS	1 PC	9 PCS	2 PCS



STEP 4

2 SET

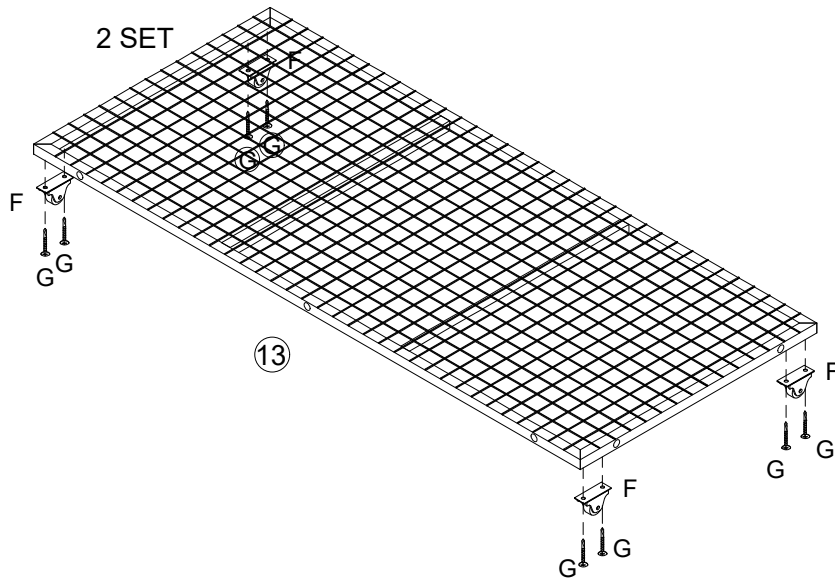

F	G
15x20x40H	M4x15
8 PCS	16 PCS

STEP 5

2 SET

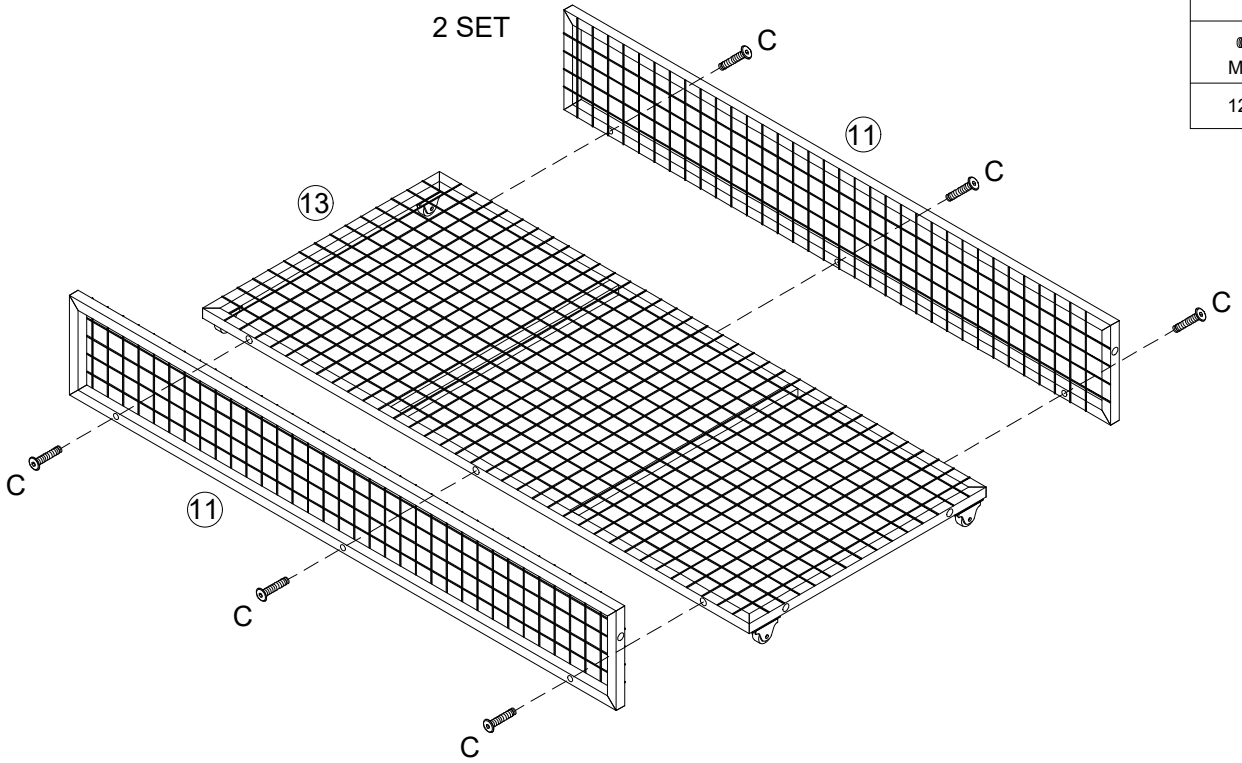

C
M $\frac{1}{2}$ "x25
12 PCS

STEP 6

2 SET

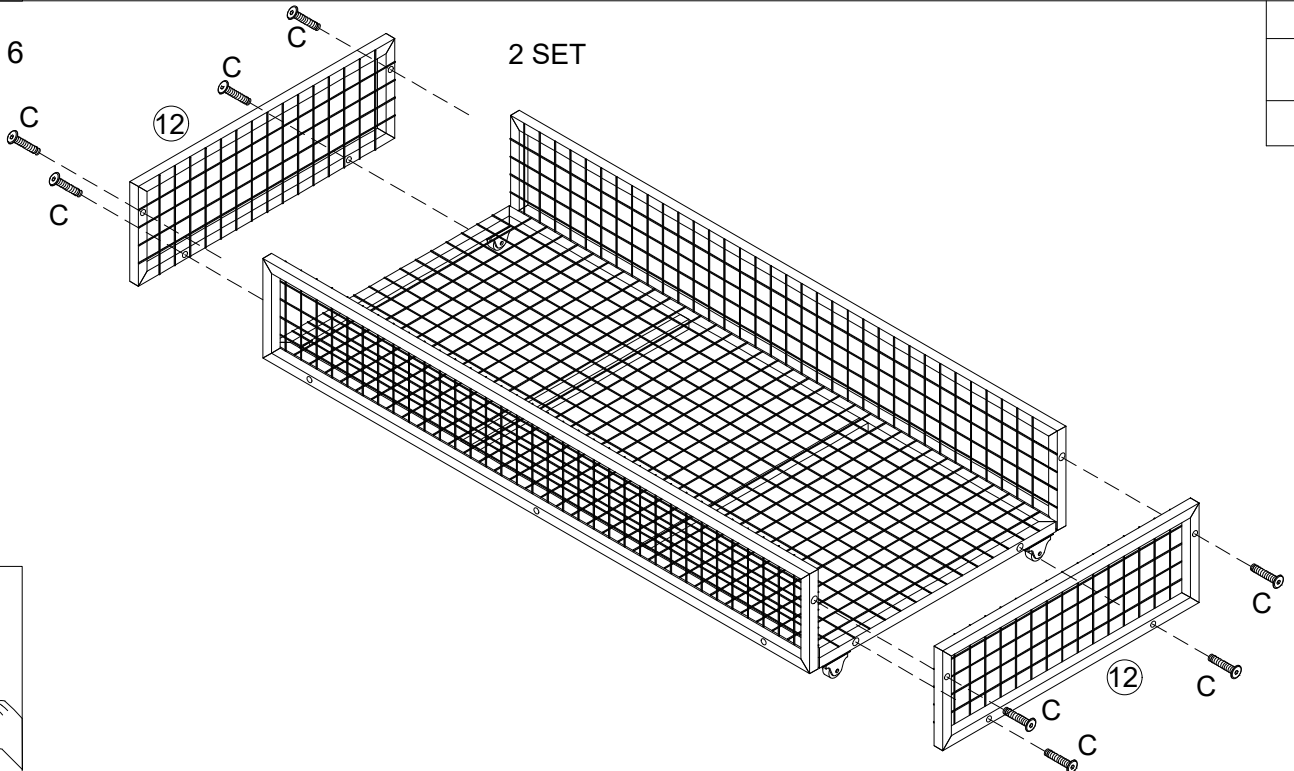

C
M $\frac{1}{2}$ "x25
16 PCS

STEP 7

