

ASSEMBLY INSTRUCTIONS



Fine Furniture for every stage of life

SOFA

ASSEMBLY INSTRUCTIONS

ASSEMBLY TIPS:

- 1.Remove hardware from box and sort by size.
- 2.Please check to see that all hardware and parts are present prior to start of assembly.
- 3.Please follow attached instruction in the same sequence as numbered to assure fast & easy assembly.



WARNING!







- 1.Don't attempt to repair or modify parts that are broken or defective. Please contact the store immediately.
- 2.This product is for home use only and not intended for commercial establishment.





ASSEMBLY TIME

5 MINUTES

PARTS IDENTIFICATION

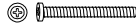
A	BACK CUSHION		2PCS
B	SEAT CUSHION		2PCS
C	SOFA FRAME		1PC
D	LEG		4PCS
E	PILLOW (SOLID)		2PCS
F	PILLOW (PATTERNED)		2PCS

Z HARDWARE PACKAGE			
NO	DESCRIPTION	FIGURE	QTY
1	MEDIUM BOLT 5/16" * 2-1/2 "		4PCS
2	PLASTIC CAPS Ø 19.5*21.5mm		4PCS

ASSEMBLY INSTRUCTIONS

STEP 1

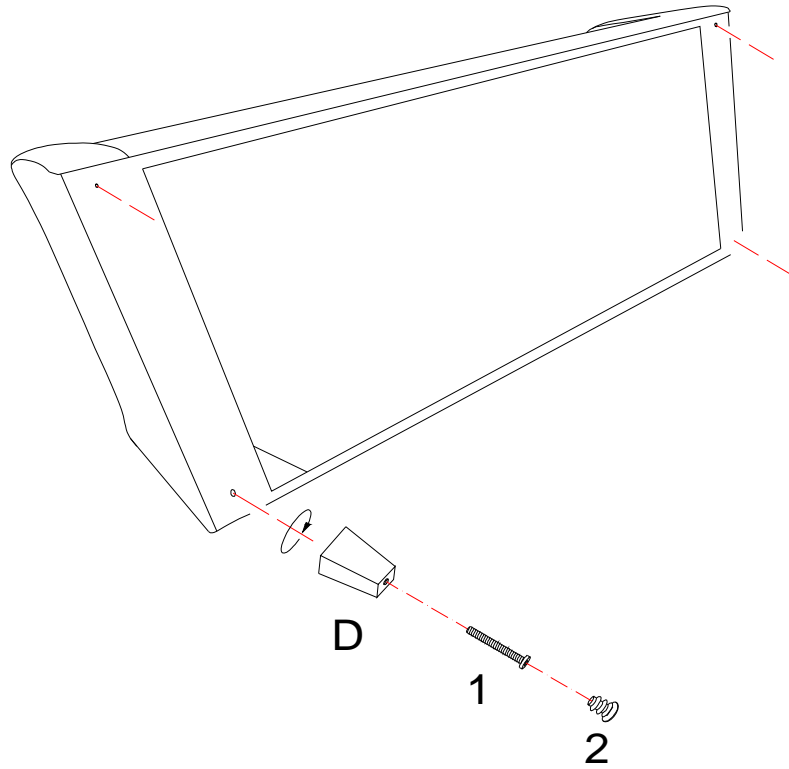

STEP 2

