

Pure & Easy

# ASSEMBLY INSTRUCTIONS

# NOTICE

IMPORTANT, RETAIN FOR FUTURE REFERENCE: READ CAREFULLY  
WICHTIG, FÜR SPÄTERE NACHSCHLAGE AUFBEWAHREN: SORGFÄLTIG LESEN  
IMPORTANTE, GUARDAR PARA REFERENCIA FUTURA: LEER ATENTAMENTE  
IMPORTANTE, CONSERVARE PER RIFERIMENTI FUTURI: LEGGERE ATTENTAMENTE  
IMPORTANT, À CONSERVER POUR RÉFÉRENCE FUTURE : LIRE ATTENTIVEMENT

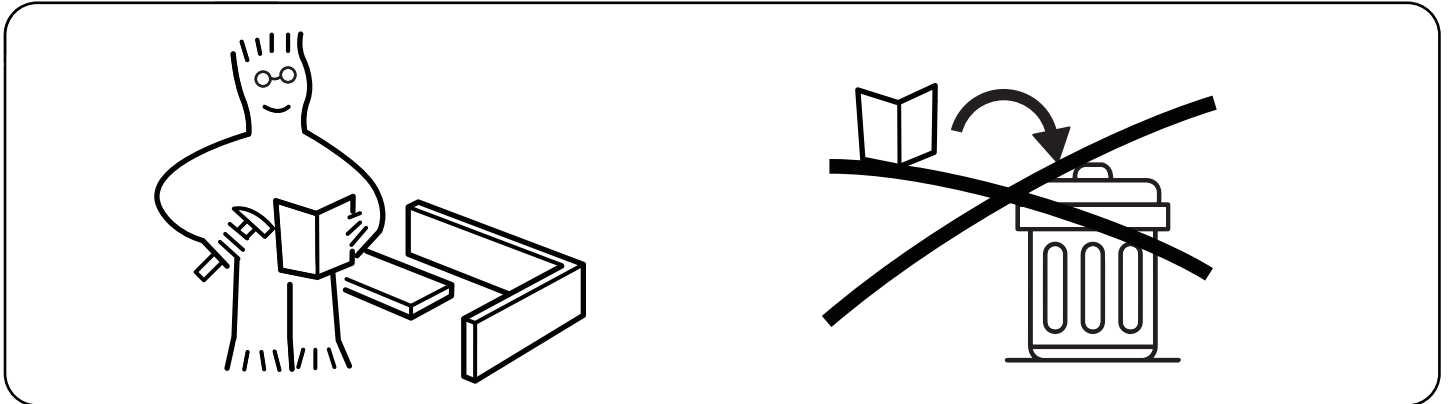

Assemble on a flat and solid surface. To avoid the unstable surface affecting the overall frame stability during installation.

Montieren Sie auf einer ebenen und festen Oberfläche. Um zu verhindern, dass eine unebene Oberfläche während der Montage die Gesamtrahmen-Stabilität beeinträchtigt.

Ensamblar en una superficie plana y sólida. Afin d'éviter que la surface inégale n'affecte la stabilité générale du cadre lors de l'installation.

Assemblare su una superficie piana e solida. Per evitare che una superficie irregolare influisca sulla stabilità complessiva della struttura durante l'installazione.

Assembler sur une surface plate et solide. Para evitar que la instalación en una superficie irregular afecte la estabilidad general del marco.

Professional installation is highly recommended.  
Eine professionelle Installation wird dringend empfohlen.  
Une installation professionnelle est fortement recommandée.  
Si raccomanda vivamente l'installazione professionale.  
Se recomienda altamente la instalación profesional.



Periodically Check That All Components Are Tightly Secured.  
Überprüfen Sie Regelmäßig, Dass Alle Komponenten Fest Gesichert Sind.  
Vérifiez Périodiquement Que Tous Les Composants Sont Bien Fixés.  
Controllare Periodicamente Che Tutti I Componenti Siano Ben Fissati.  
Verifique Periódicamente Que Todos Los Componentes Estén Bien Asegurados.



It is recommended that multiple people assemble this product.  
Es wird empfohlen, dass mehrere Personen dieses Produkt zusammenbauen.  
Il est recommandé que plusieurs personnes assemblent ce produit.  
Si raccomanda che più persone assemblino questo prodotto.  
Se recomienda que varias personas ensamblen este producto.

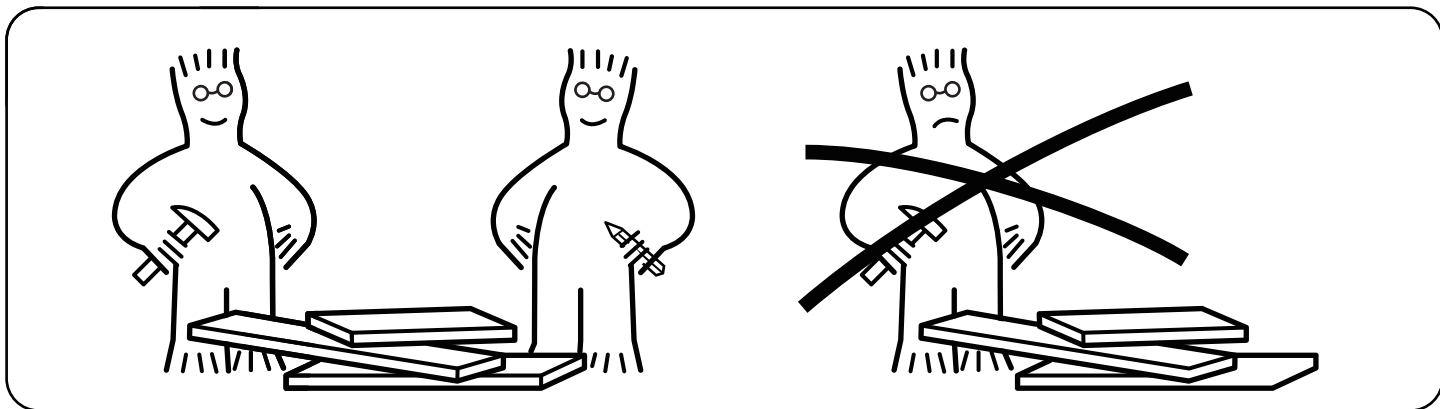

Please have the following auxiliary tools ready:

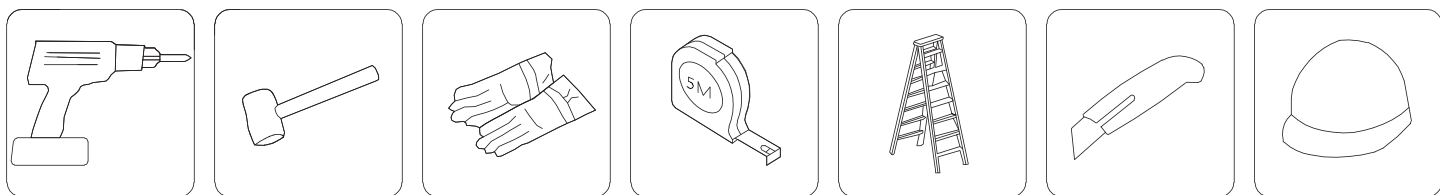

**SITE PREPARATION | PRÉPARATION DU SITE | PREPARACIÓN DEL LUGAR | VORBEREITUNG DES AUFSTELLUNGORTES | VOORBEREIDING VAN HET TERREIN | PREPARAZIONE DEL LUOGO DI ASSEMBLAGGIO | PREPARAÇÃO DO LOCAL**

**Level the ground surface | Nivelez la surface du sol | Nivele la superficie del suelo | Ebenen Sie die Bodenoberfläche | Maak de bodem vlak | Livellare la superficie del terreno | Nivele a superfície do solo**

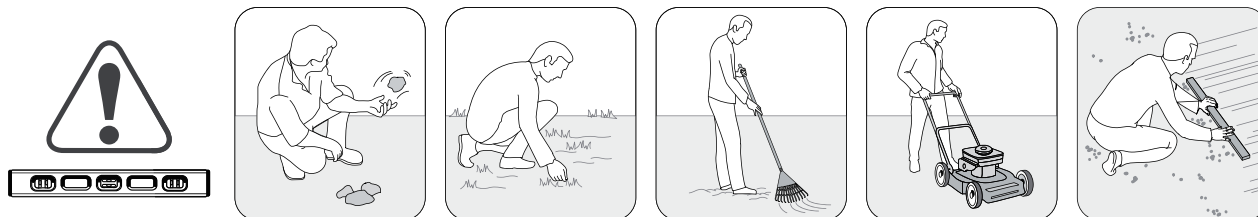

**Recommendation: Construct a wooden or concrete base as a foundation |** Recommandation: fabriquez une base en bois ou en béton en guise de fondation | **Recomendación: construya una base de madera o de cemento a modo de cimiento |** Empfehlung: Bauen Sie als Fundament eine Grundfläche aus Holz oder Beton | **Aanbeveling: maak een houten of betonnen ondergrond als fundering |** Raccomandazione: Costruire una base di legno o di cemento come fondamenta | **Recomendação: Construa uma base de madeira ou de cimento como fundação**

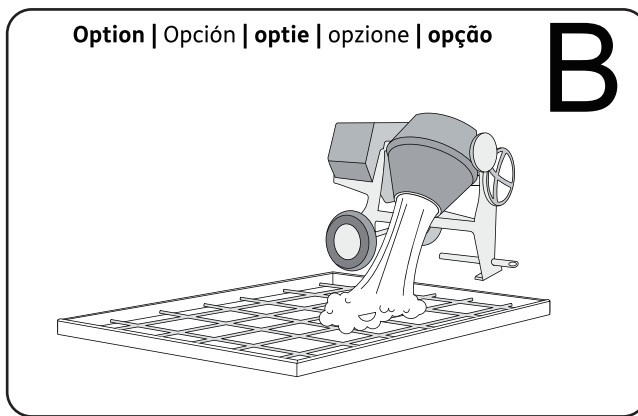
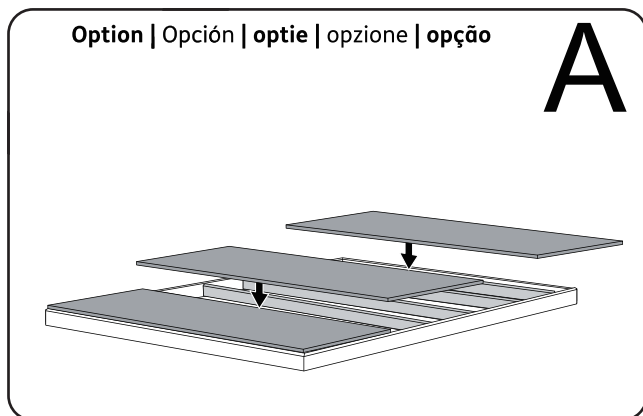

**External floor measurements are: | Les mesures externes de la étage sont: | Las medidas del suelo externo son: | Die Außen-Bodenmaße betragen: | De afmetingen van de externe vloer zijn: | Le dimensioni esterne del pavimento sono: | As medidas externas do chão são:**



---

**BEFORE STARTING ASSEMBLY | AVANT DE COMMENCER LE MONTAGE | ANTES DE EMPEZAR EL ARMADO | VOR MONTAGEBEGINN | VOORDAT U BEGINT TE MONTEREN | PRIMA DI INIZIARE L'ASSEMBLAGGIO | ANTES DE INICIAR A MONTAGEM**

---

**Read the care and safety guidelines at the end of this manual | Check to ensure that there are no missing or damaged parts BEFORE starting or arranging assembly | Remove all parts from the package(s) and spread them out on a clean work surface | Review all assembly instructions | Assemble all the parts according to the directions in this manual. Do not skip any steps.**

Lisez les instructions de précaution et de sécurité à la fin de ce manuel | Assurez-vous qu'il n'y a pas de pièces manquantes ou endommagées AVANT de commencer ou d'organiser l'assemblage | Retirez toutes les pièces du/des paquet(s) et étalez-les sur une surface de travail propre | Lisez toutes les instructions de montage | Assemblez toutes les pièces selon les instructions de ce manuel. Ne sautez aucune étape.

**Lea las instrucciones de precauciones y seguridad que están al final de este manual | Asegúrese de que no faltan piezas ni están dañadas ANTES de comenzar o disponer el montaje | Saque todas las piezas del paquete o paquetes y póngalas sobre una superficie de trabajo limpia | Revise todas las instrucciones de montaje | Monte todas las piezas según las instrucciones de este manual. No se saltee ningún paso.**

Lesen Sie die Sicherheitsrichtlinien am Ende des Benutzerhandbuchs durch | Prüfen Sie bitte VOR dem Zusammenbau, dass keine Teile beschädigt sind oder fehlen | Nehmen Sie alle Teile aus der Verpackung und breiten Sie sie auf einer sauberen Arbeitsfläche aus | Gehen Sie noch einmal die komplette Aufbauanleitung durch | Bauen Sie alle Teile entsprechend der Anleitung in diesem Handbuch zusammen. Lassen Sie dabei keinen Arbeitsschritt aus.

**Lees de richtlijnen voor zorg en veiligheid achterin deze handleiding | Controleer dat er geen onderdelen mankeren, of beschadigd zijn, VOORDAT u met de montage begint | Haal alle onderdelen uit het pakket (of uit de pakketten) en leg ze opeen schoon werkoppervlak | Bekijk alle montagehandleidingen | Monteer alle onderdelen volgens de aanwijzingen van deze handleiding. Sla geen stappen over.**

Leggere le linee guida di assistenza e sicurezza alla fine di questo manuale | Assicurarsi che non ci siano parti mancanti o danneggiate PRIMA di iniziare l'assemblaggio | Estrarre tutti i componenti dall'imballo e posizzarli su una superficie di lavoro pulita | Consultare tutte le istruzioni di montaggio | Assemblare tutti i componenti secondo le istruzioni contenute nel manuale. Non saltare nessuna fase.

**Leia as diretrizes de cuidados e segurança que constam da parte final deste manual | Verifique para se assegurar de que não há peças em falta ou danificadas ANTES de começar a preparar a montagem | Retire todas as peças da embalagem e espalhe-as numa superfície de trabalho limpa | Reveja todas as instruções de montagem | Monte todas as peças de acordo com as instruções do manual. Não salte quaisquer passos.**

---

**SPATULA | SPATULE | ESPÁTULA | SPACHTEL | SPATEL | SPATOLA | ESPĂȚULA**

---

- Use spatula (part "SG8") for easier insertion of panel into profile.
- Utilisez la spatule (partie "SG8") pour une meilleure insertion du panneau dans le profil.
- Utilice una espátula (pieza "SG8") para una mejor inserción del panel en el perfil.
- Benutzen Sie den Spachtel (Bezeichnung "SG8"), um die Platten leichter in die Nut einführen zu können.
- Gebruik spatel (onderdeel SG8) voor het gemakkelijk invoeren van het paneel in het profiel.
- Utilizzare la spatola (parte SG8) per inserire il pannello più facilmente nel profilo.
- Utilize uma espátula (peça "SG8") para facilitar a inserção do painel no perfil.

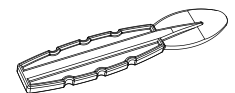









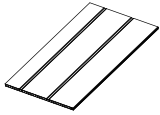

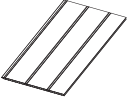
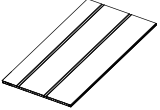

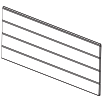





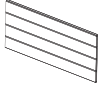







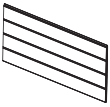
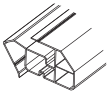



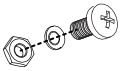

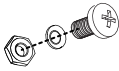



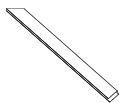

**SG8 x1**

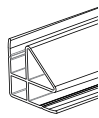

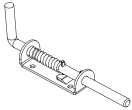





- Use spatula  (part "SG8") for easier insertion of panel into profile
- Please ensure the panels are all installed on position before screwing
- Please be mindful of the screw size used during installation; using screws that are too long may damage the shed.



# PARTS

Item no.	Reference Image	Qty.	Item no.	Reference Image	Qty.
WF1-2		X1	WR2-2		X1
WF1-1		X1	WR2-3		X1
WF1-3		X1	W2-4		X2
WB2-1		X2	WD3-1		X1
WB2-2L		X1	WD3-2		X1
WB2-3L		X1	WP1		X1
WB3-1		X2	WP3		X1
WB3-2		X1	WP5		X2
WB2-2R		X1	WS7		X2
WB2-3R		X1	WP8		X2
WR2-1		X1	WP9		X2

Item no.	Reference Image	Qty.	Item no.	Reference Image	Qty.
WP14		X4	WP27		X1
RF10	 M4x25mm	X4	WP28		X1
RF9	 M8x25mm	X4	WP22		X4
WS8		X4	SG6		X2
WP15		X2	SG2		X4
WAS		X1	SG7-4		X1
WP17		X2	SG7-3		X1
WP18L		X1	DC		X2
WP18R		X1	SG8		X1
WP19		X1	Drill		X1
WP20		X1	Z410	 M4x10mm	X20

Item no.	Reference Image	Qty.	Item no.	Reference Image	Qty.
Z420	 M4x20mm	X67	LOCK-5		X1
ZW413	 M4x10mm	X40	LOCK-6		X1
M06		X2	Z310	 M3x10mm	X24
M05		X6	SG14		X4

## EXPLODED VIEW

Roof section

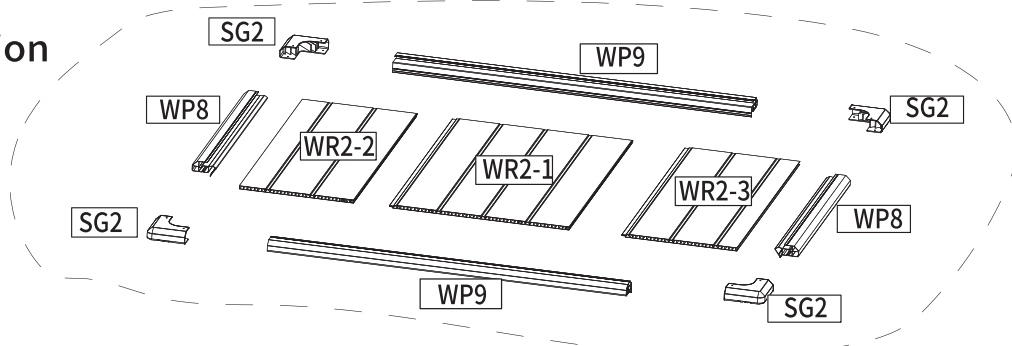

Rear part

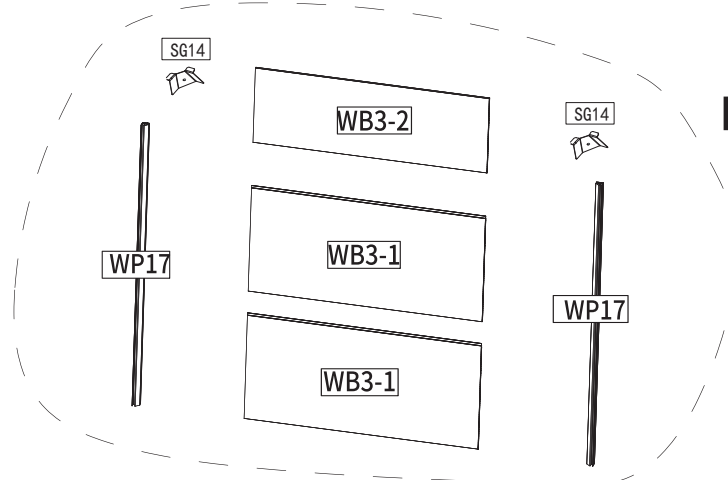

# EXPLODED VIEW

Left part

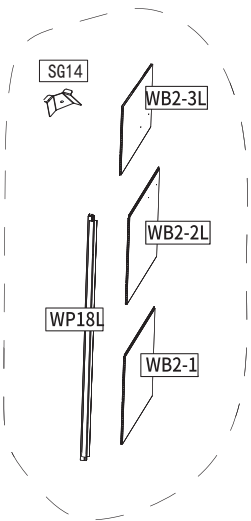

Front part

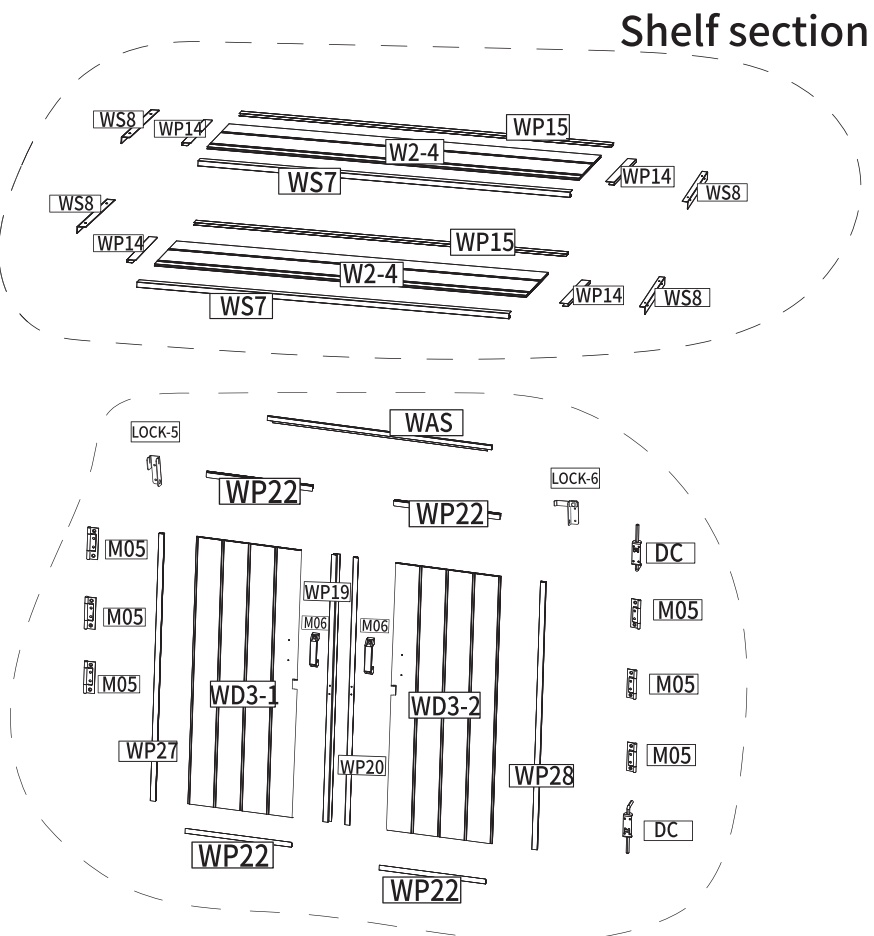

Shelf section

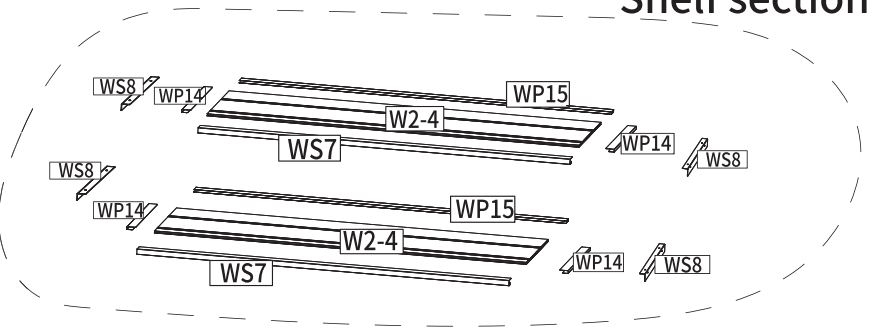

Right part

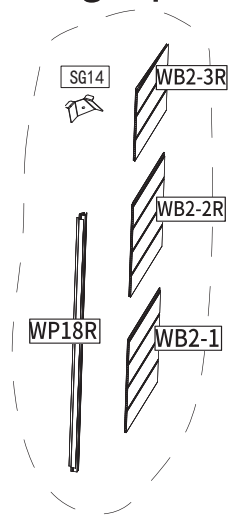

Floor section

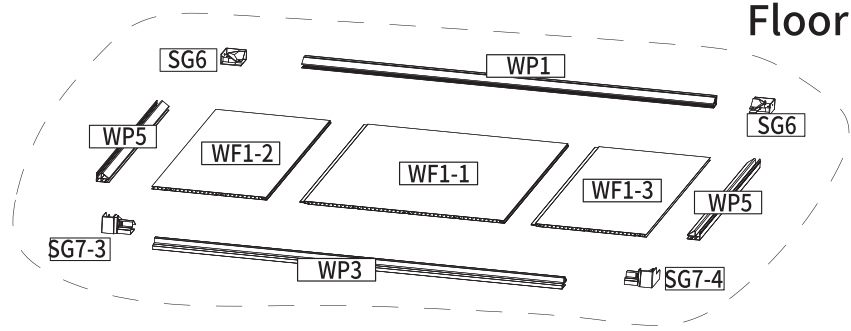

# ASSEMBLY

## FLOOR ASSEMBLY

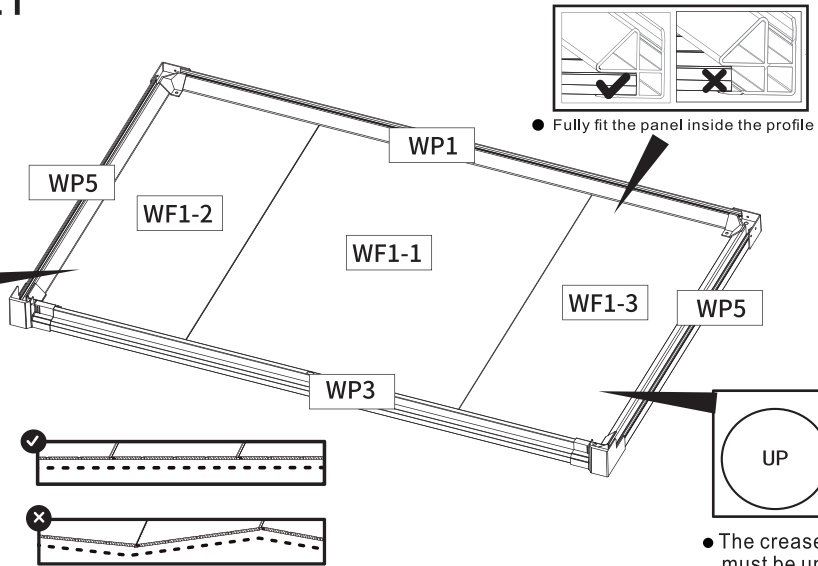

# 1

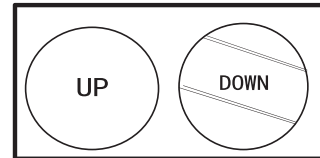
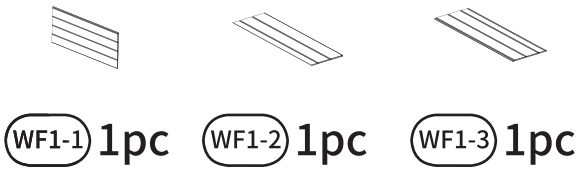

The crease line of the floor must be underneath

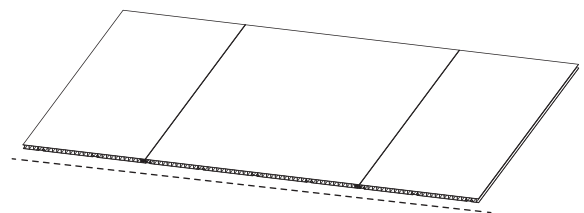
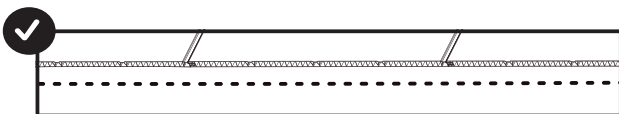
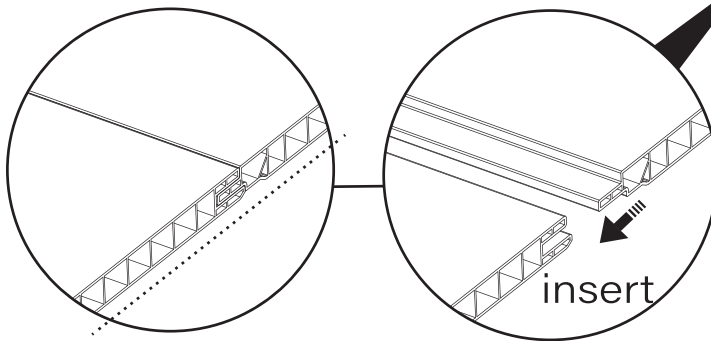
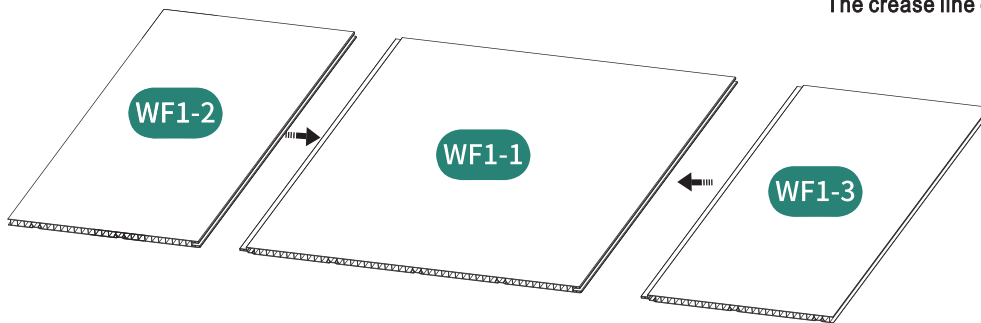

# 2

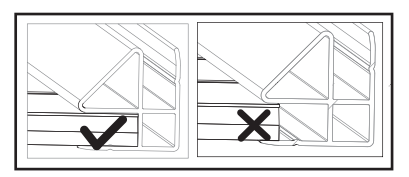
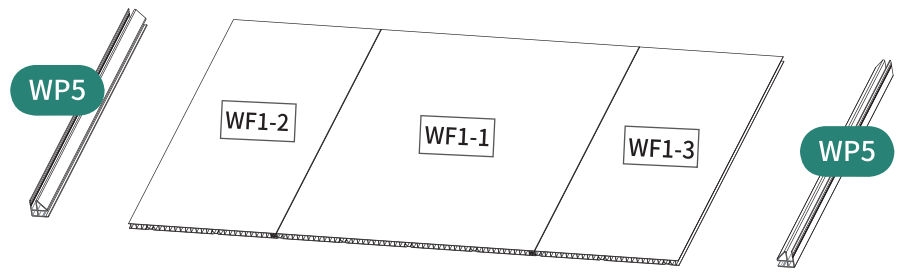
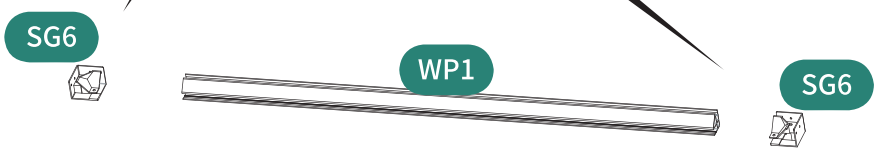
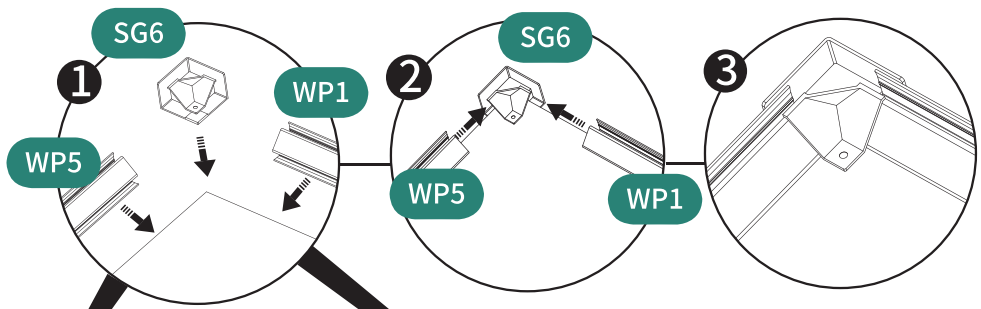
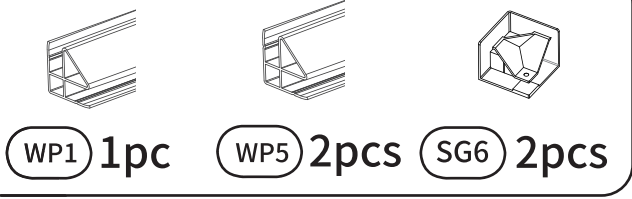

● Fully fit the panel inside the profile

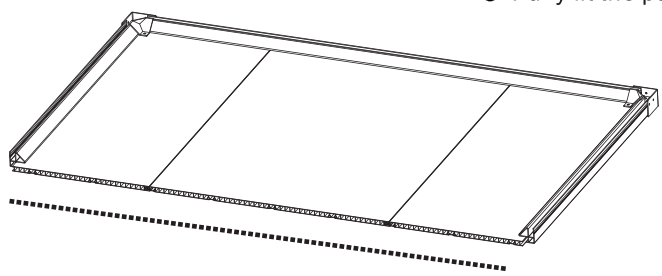

The floor must be straight.

# 3



WP3 1pc



SG7-3 1pc



SG7-4 1pc

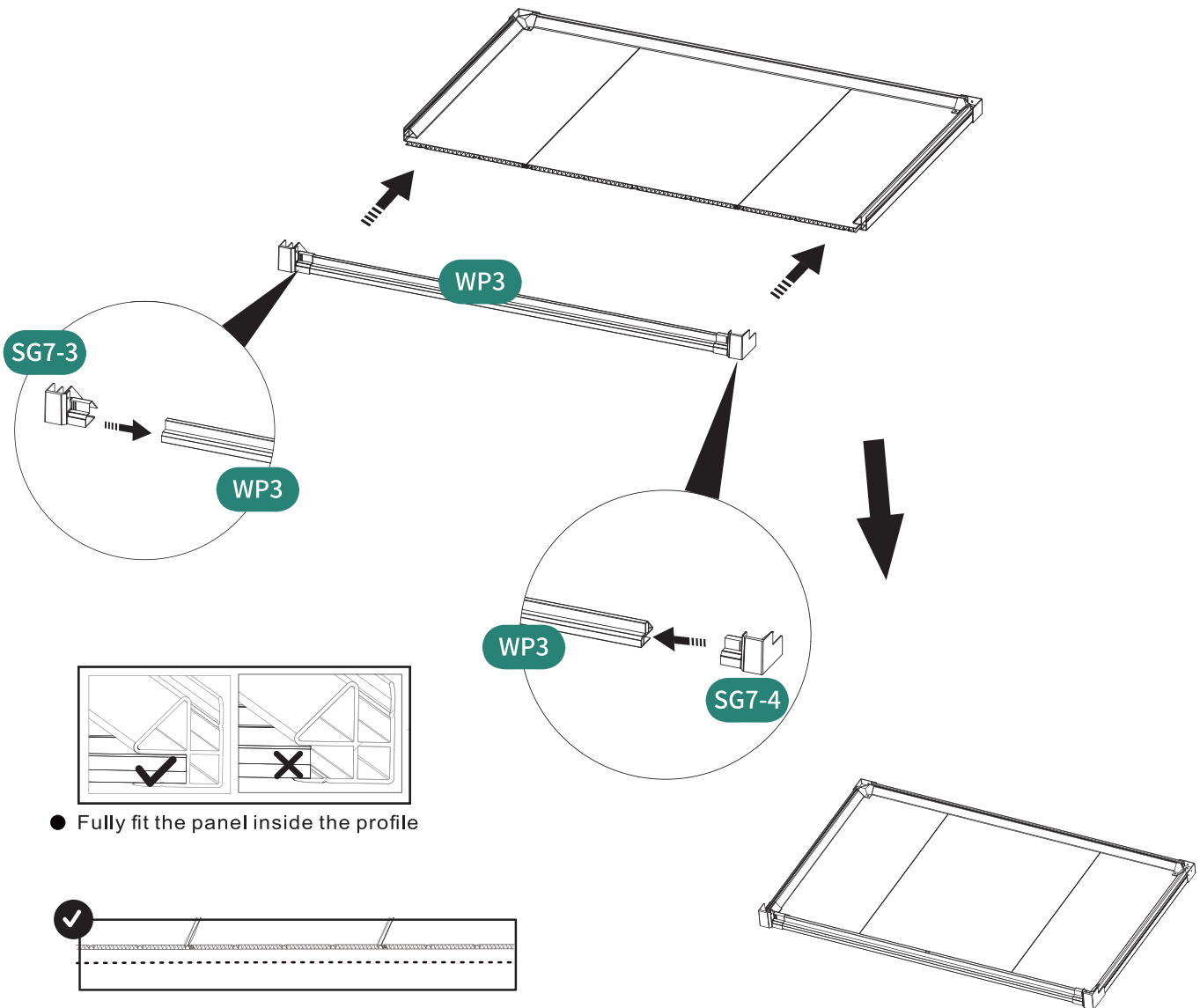

Assembly preview

# 4



Z410 2pcs

Before inserting screws, you can gently tap the side with a hammer to adjust the distance so that it is  $AB=CD$ .

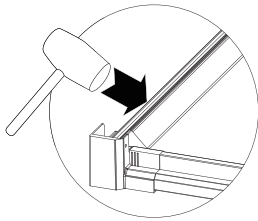

$AB=CD$

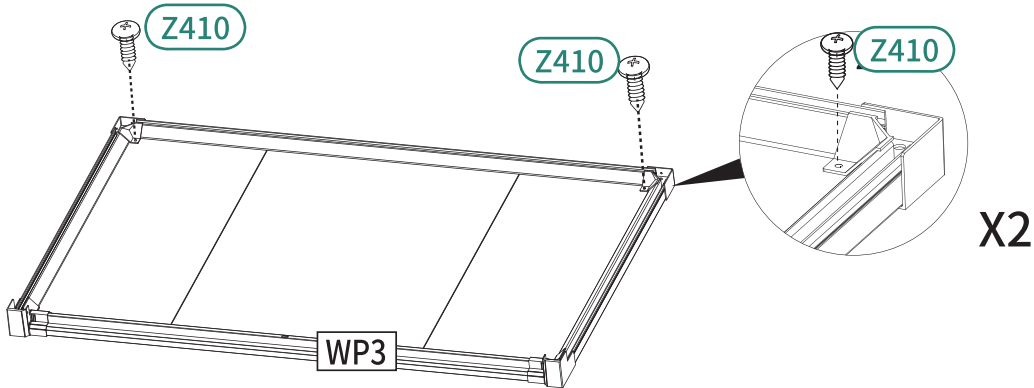
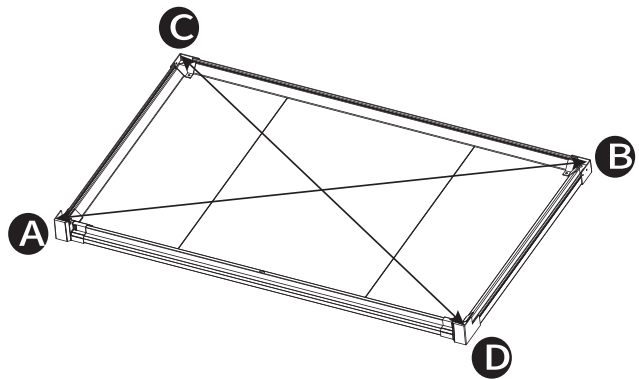

● Turn over the floor panel

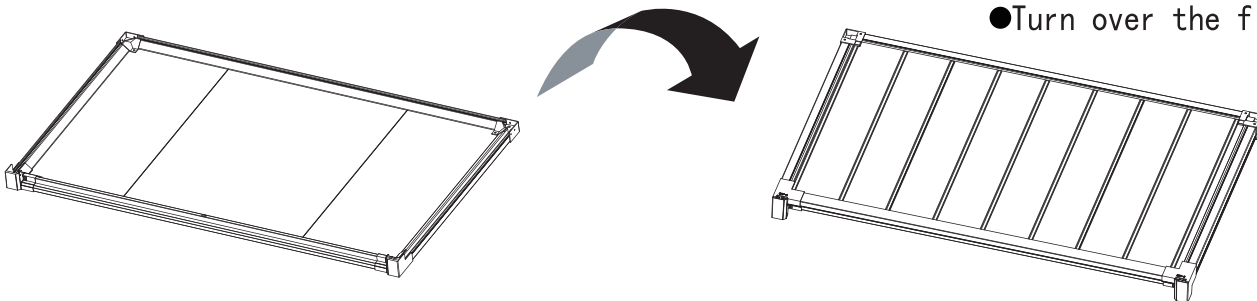

# 5



Z420 14 pcs

Caution:

Please use Drill  to predrill a hole at depth 1mm before screw.

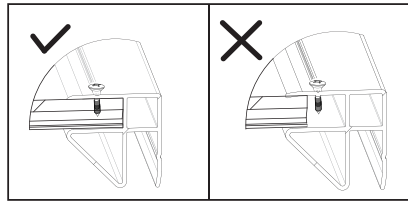
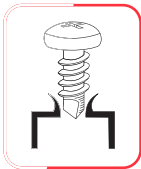
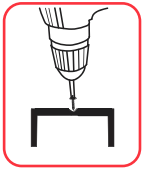

● Fully fit the panel inside the profile; then screw on mark line

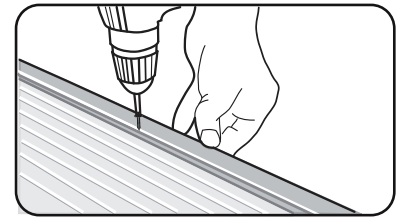

● Nail along the marked line on profile

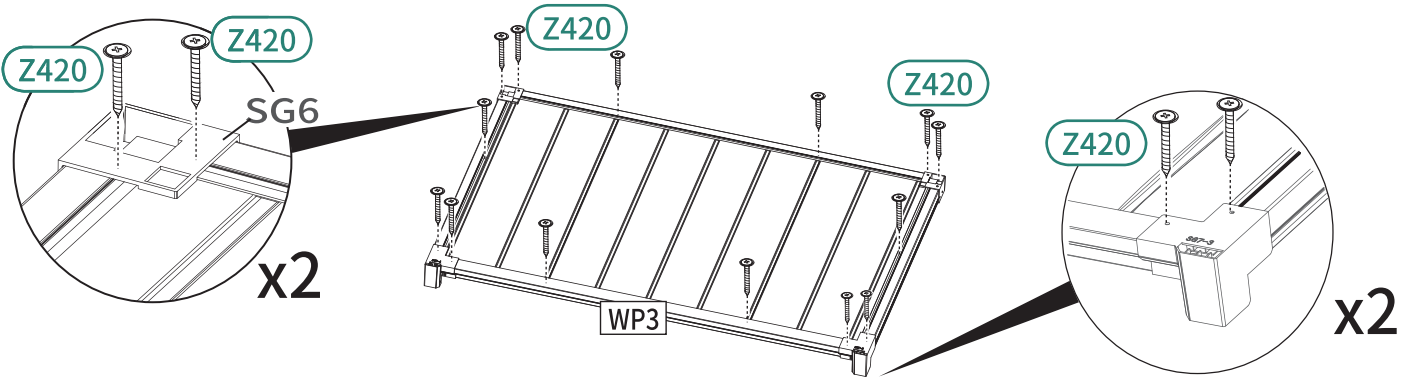

● Turn over the floor panel

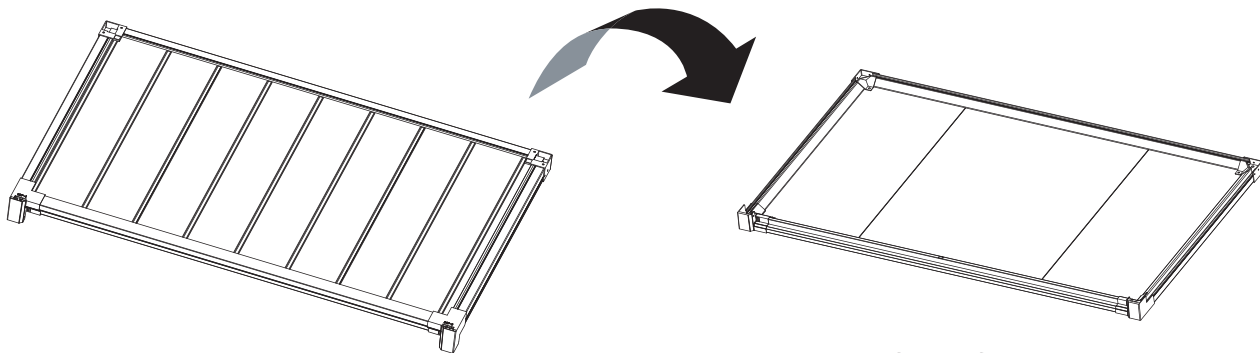

The crease of the floor must be underneath.

## WALLASSEMBLY

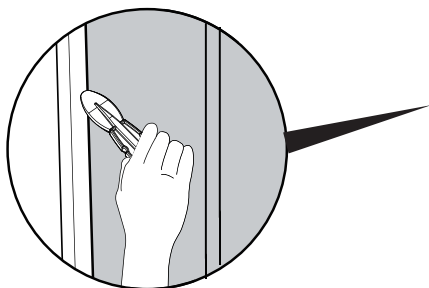

● Use spatula  (part "SG8") for easier insertion of panel into profile

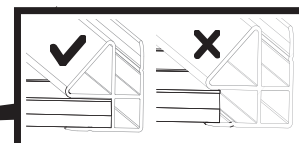
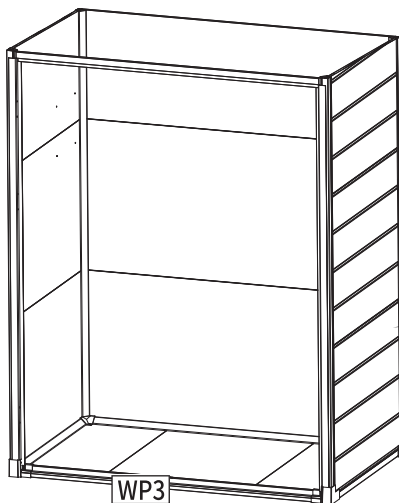

● Fully fit the panel inside the profile

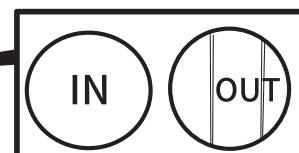

# 6

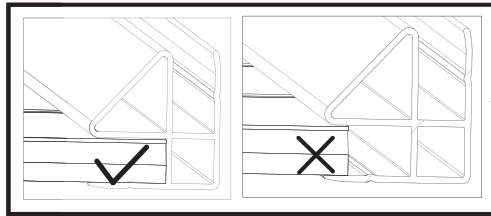
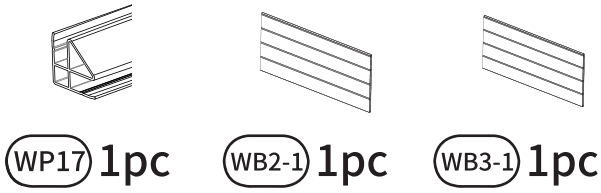

● Fully fit the panel inside the profile

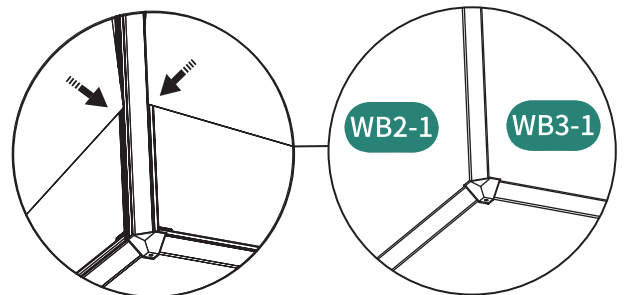
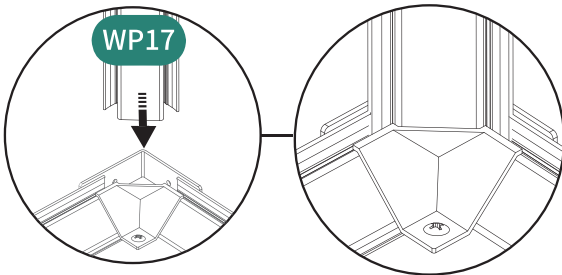
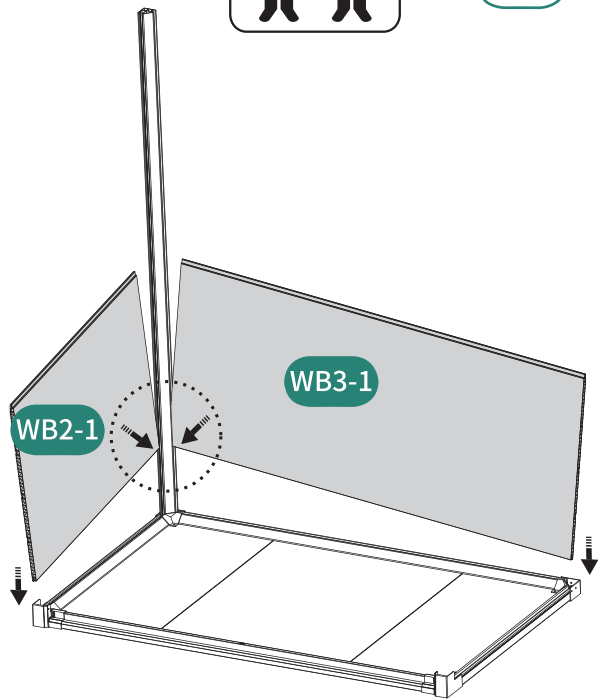
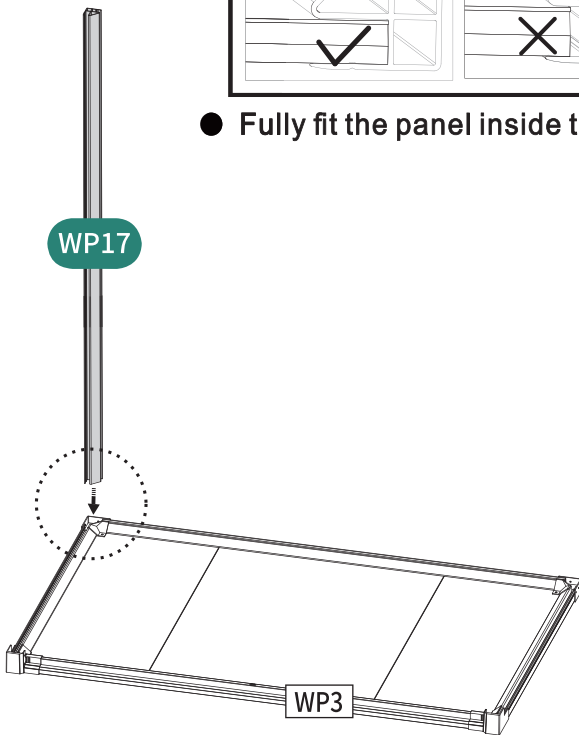
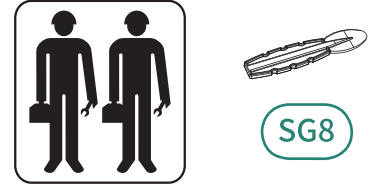

7

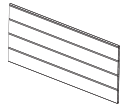

WB2-2L 1pc

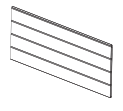

WB3-1 1pc

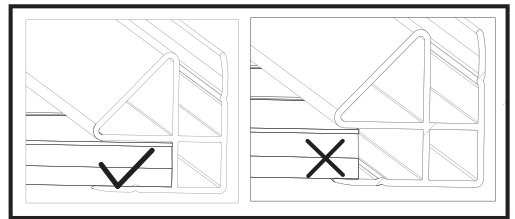
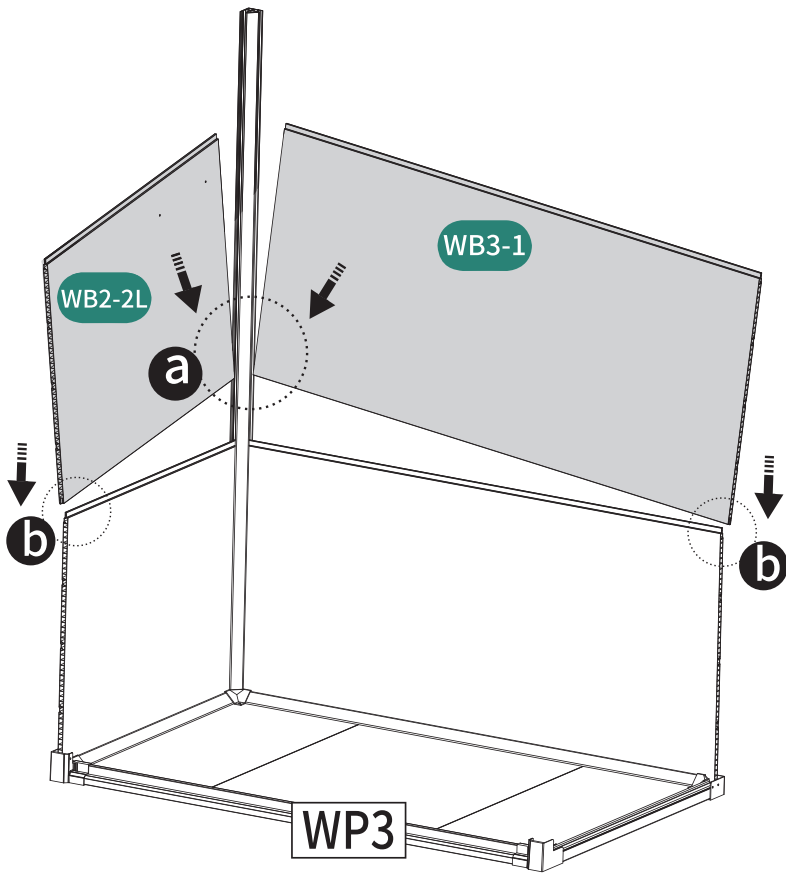
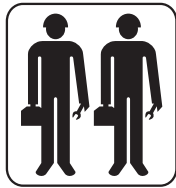



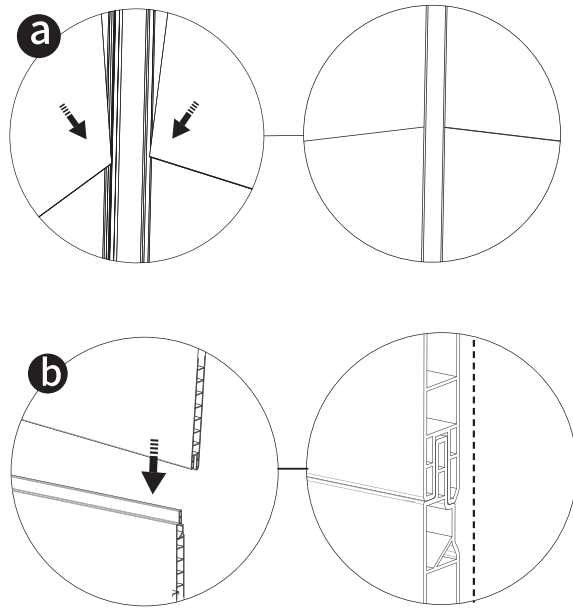

● Fully fit the panel inside the profile

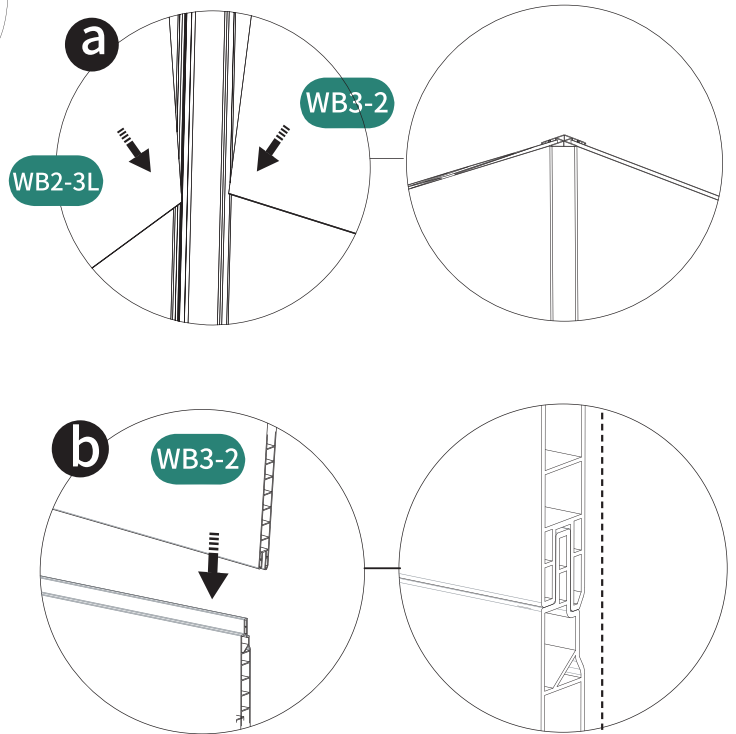
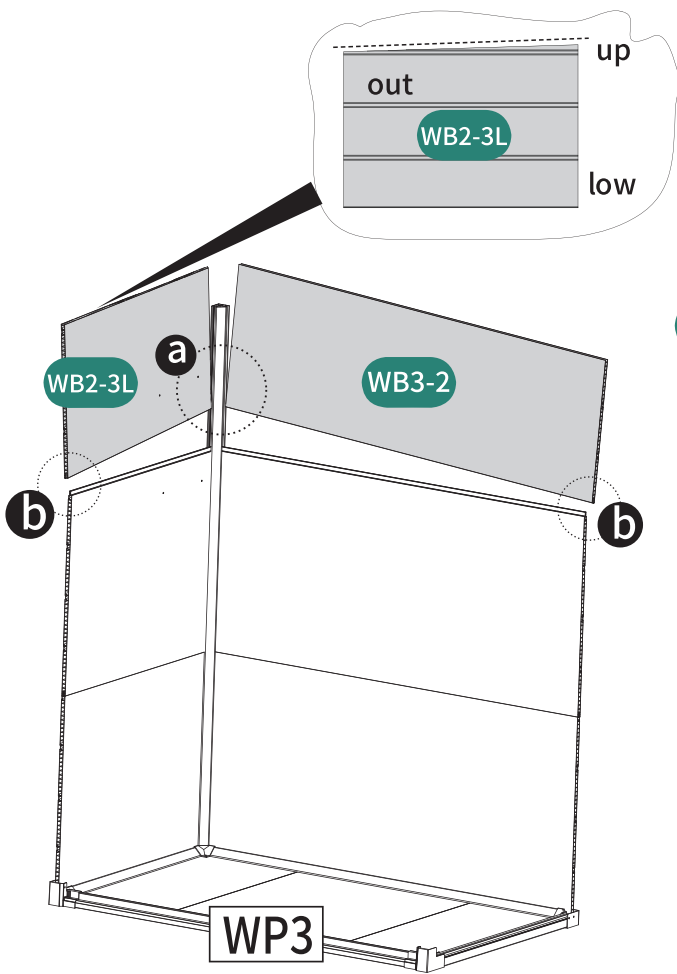
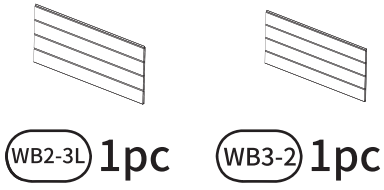

8

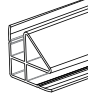

9

-  WP17 1pc
-  WB2-3R 1pc
-  WB2-2R 1pc
-  WB2-1 1pc

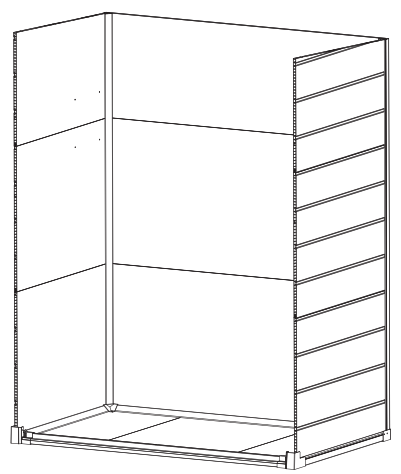
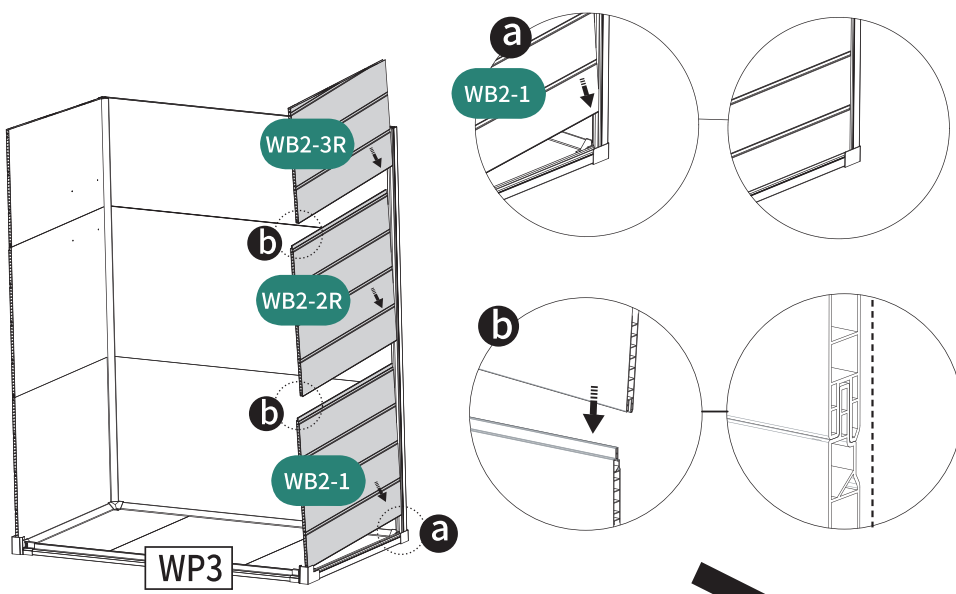
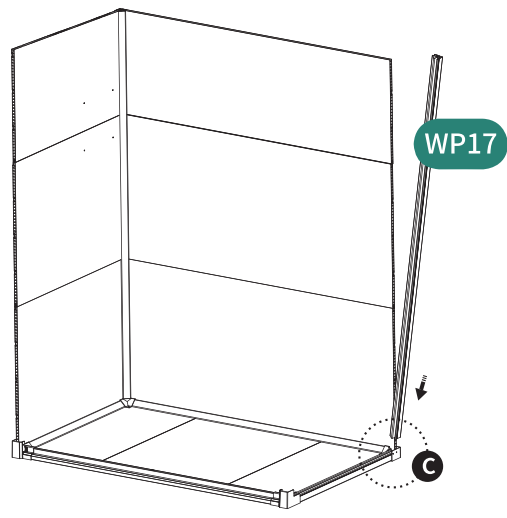
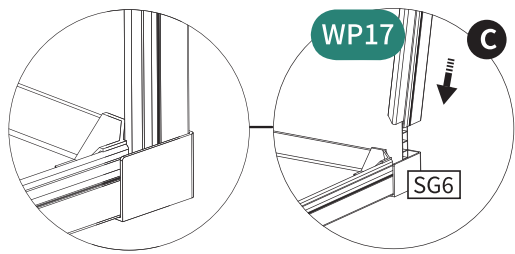

Assembly preview

# 10



WP18L 1pc



WP18R 1pc



WAS 1pc

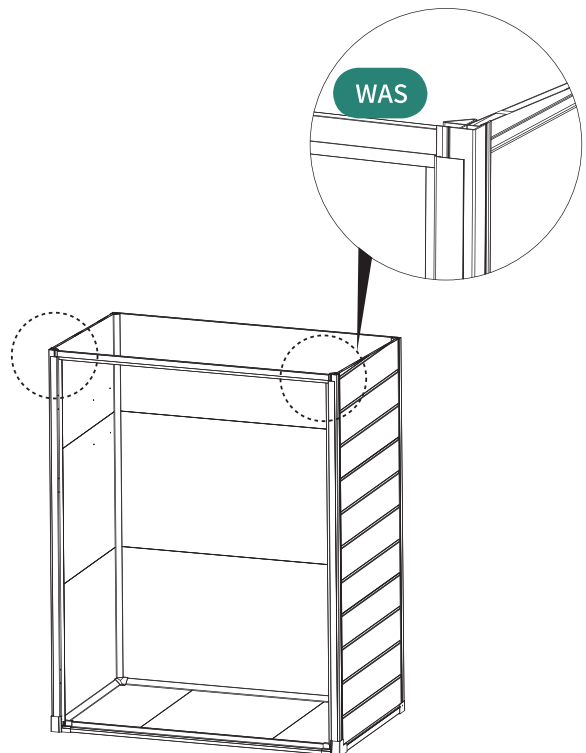
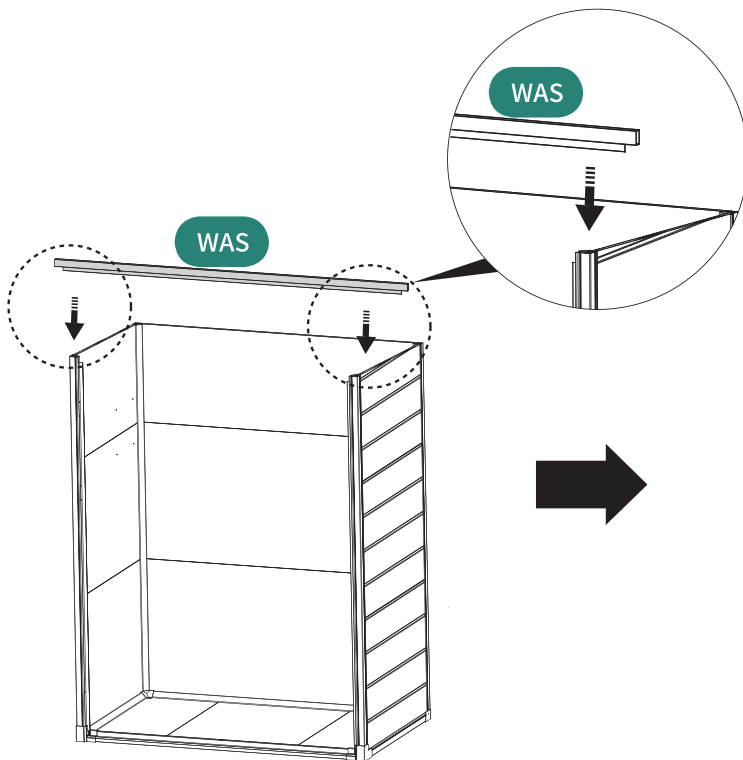
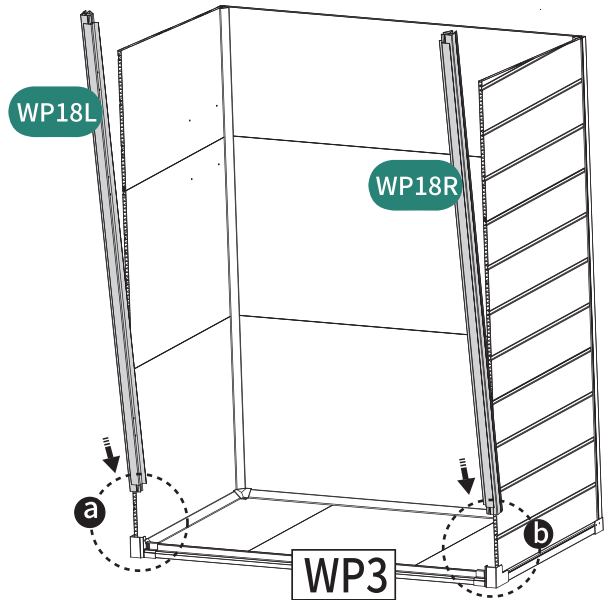
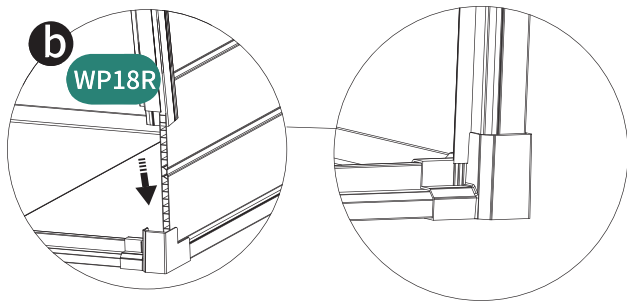
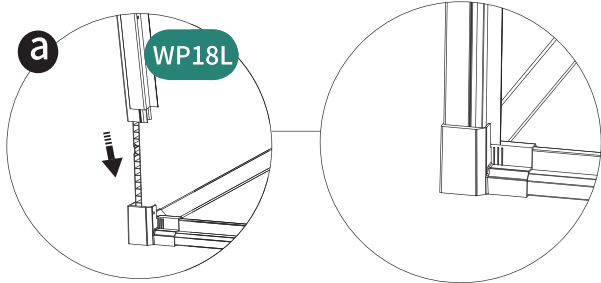

# 11

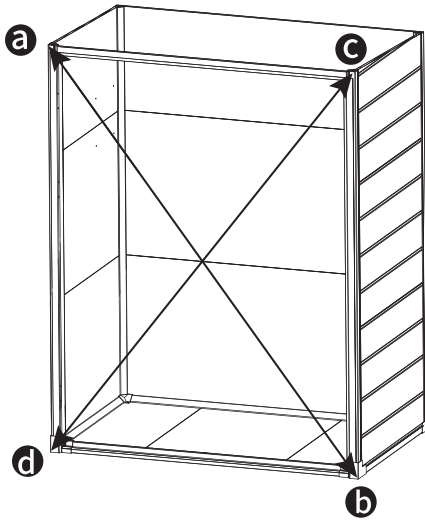

Ensure  $ab=cd$

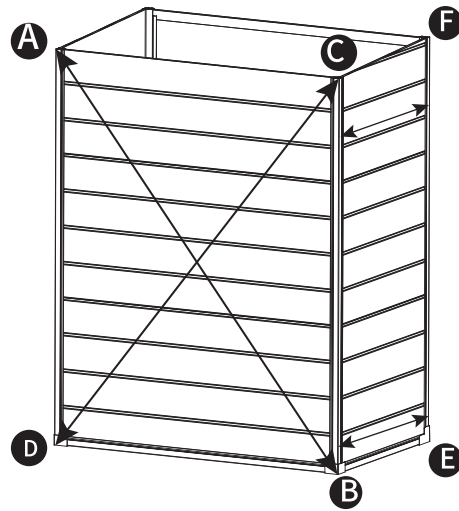

Ensure  $AB=CD$

Ensure  $CF=BE$

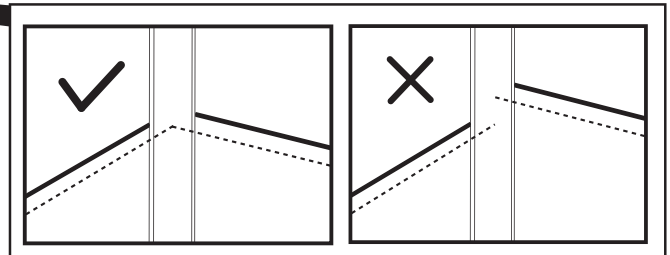
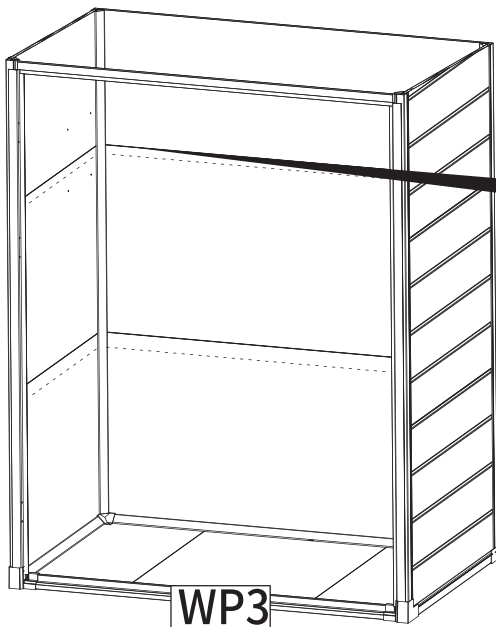

# 12



ZW413 2pcs



Z420 27pcs

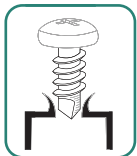
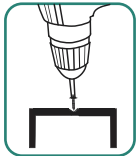

Please use Drill  to predrill a hole at depth 1mm before screw.

Make sure everything is in place and turn the screws.

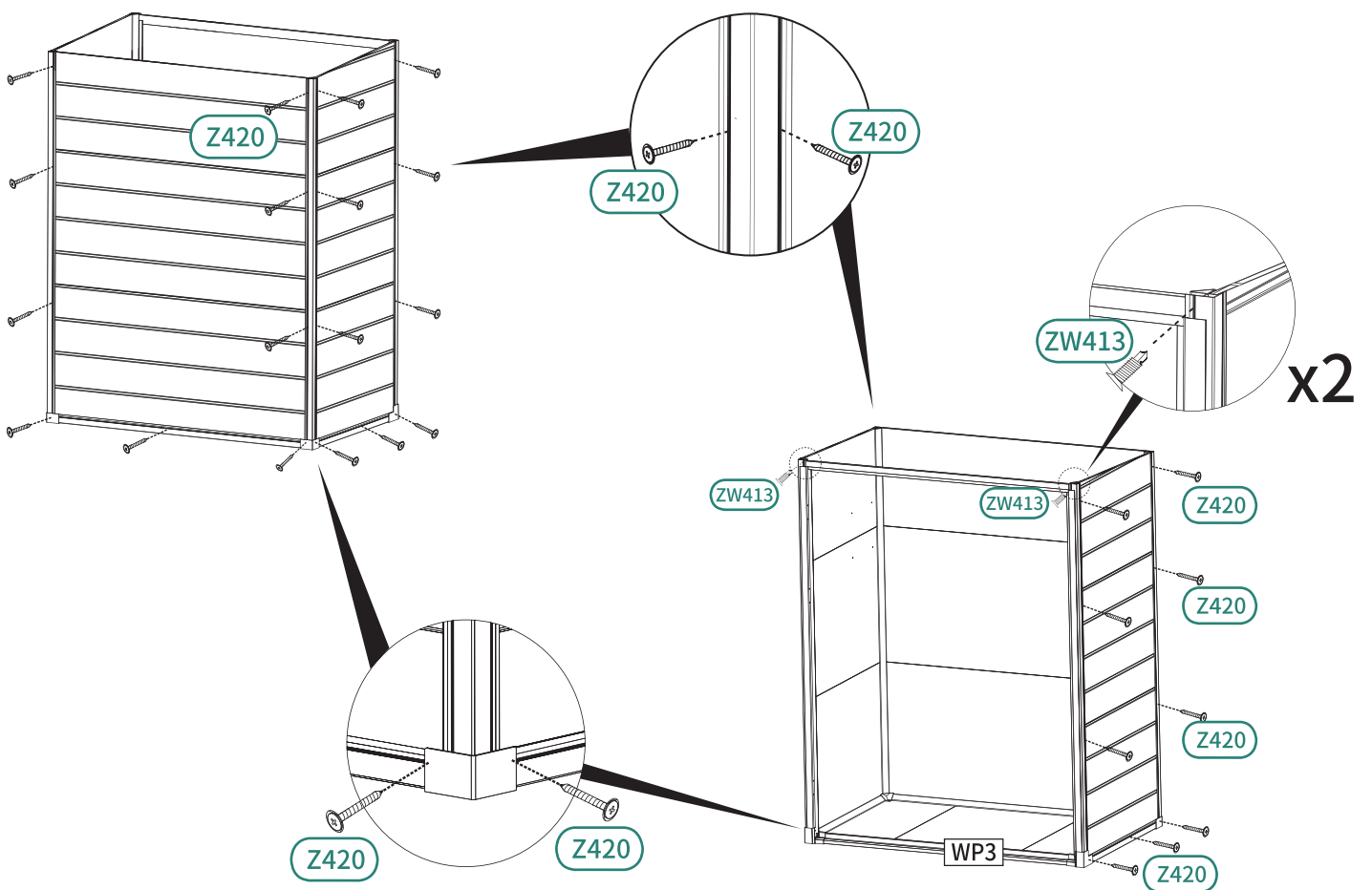

# ROOFASSEMBLY



SG8

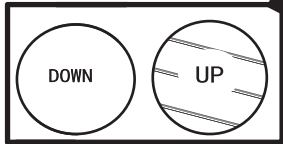

The stripes should be upwards

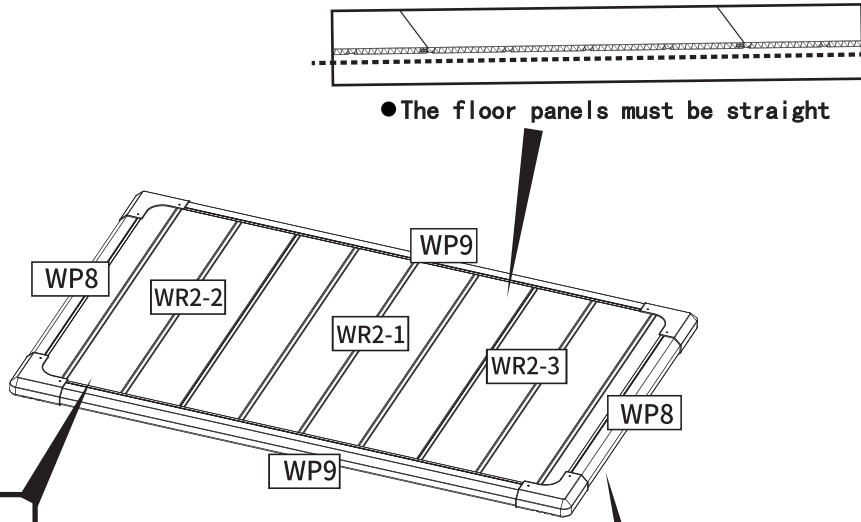

● The floor panels must be straight

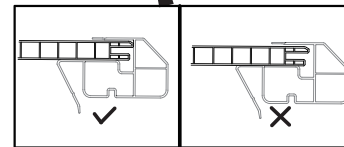

● Fully fit the panel inside the profile

# 13



WR2-1 1pc

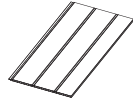

WR2-2 1pc



WR2-3 1pc

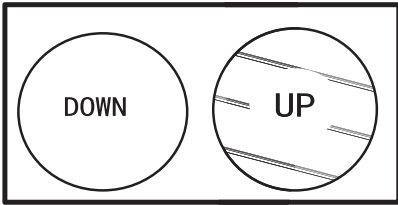

The stripes should be upwards

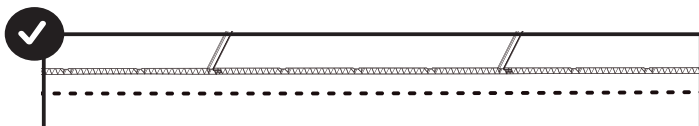
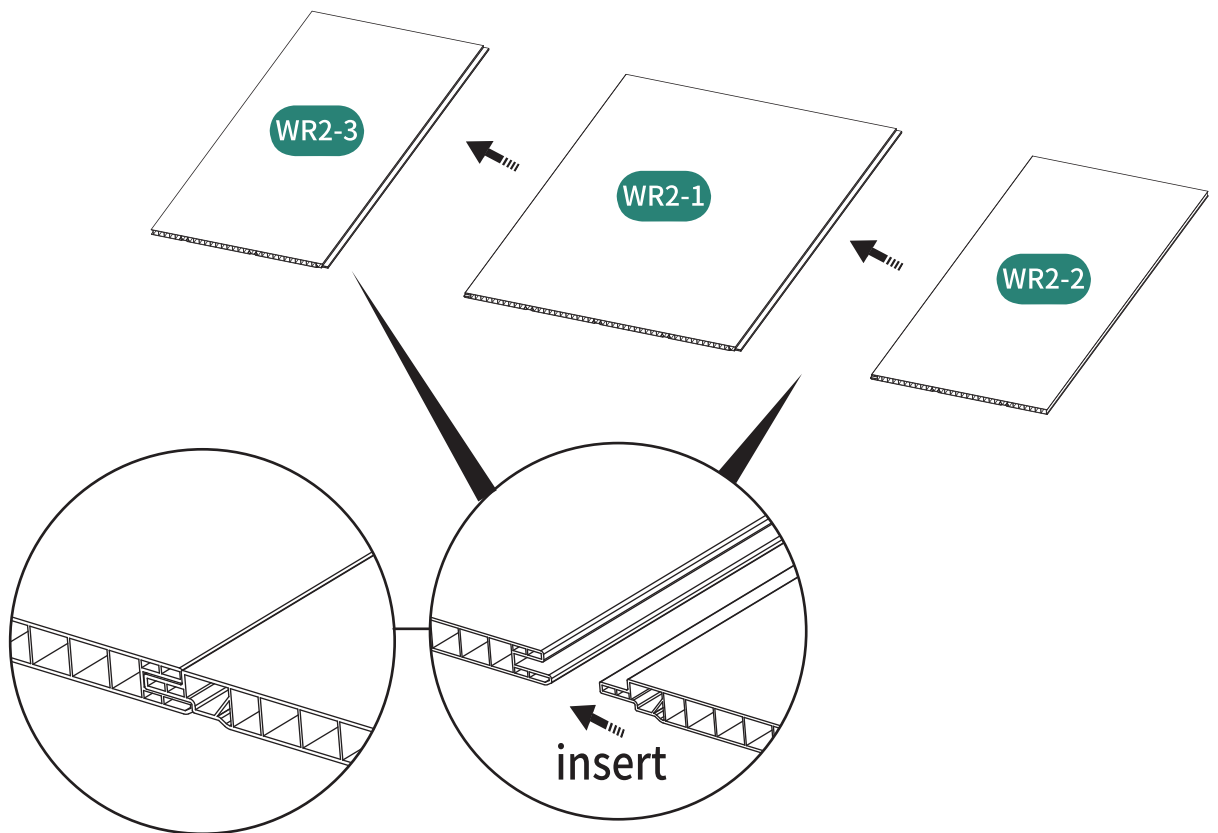



# 15



Z410 8pcs



Z420 14pcs

## Assembly preview

Make sure  $AB=CD$  before you screw

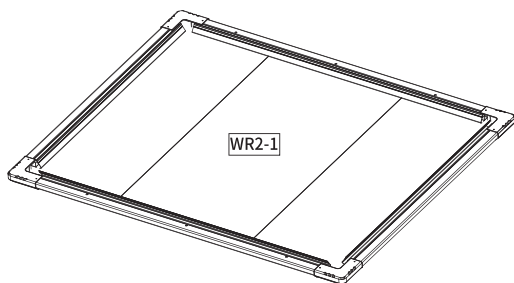
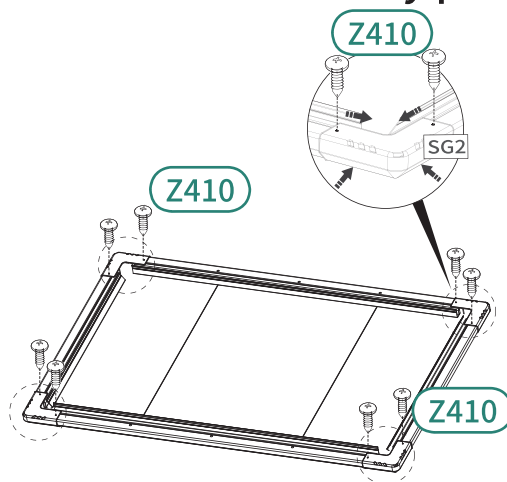
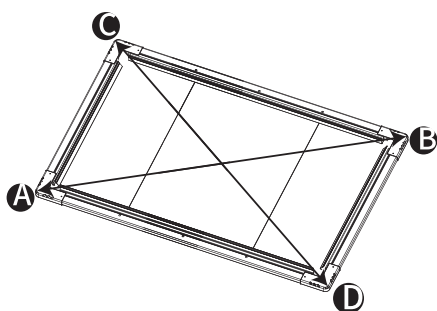

Flip the roof over

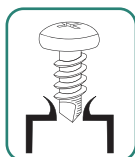
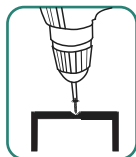
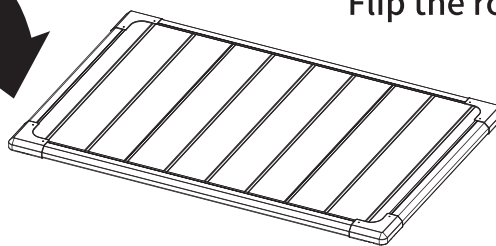

Please use Drill  to predrill a hole at depth 1mm before screw.

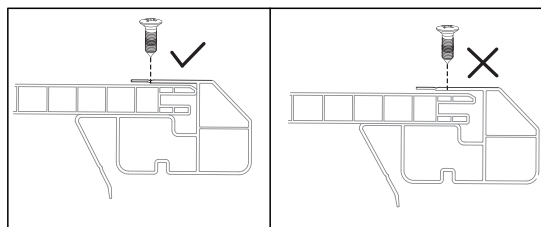

● Nail along the marked line on profile.

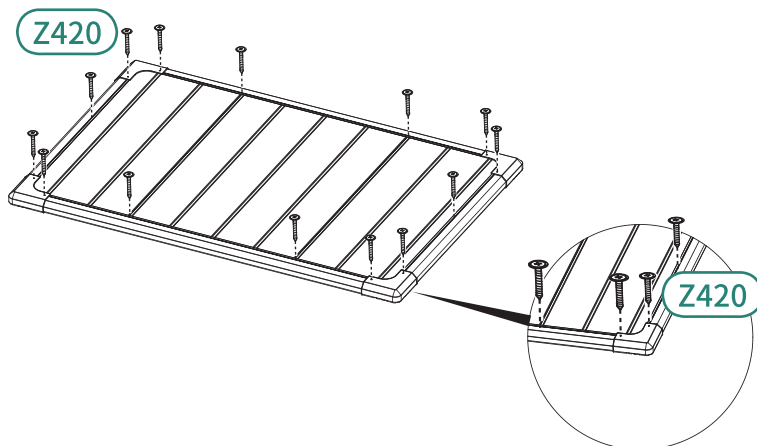

**16**



Z420 8pcs

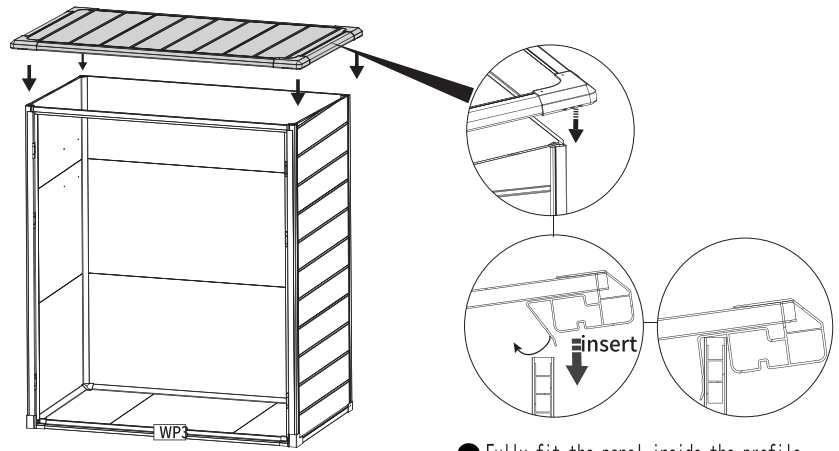

● Fully fit the panel inside the profile

Ensuring the correct installation of the shed roof is paramount, as there should be no gaps between the roof and the walls. If any gaps are present, they must be checked and addressed. It is recommended that two people assist in the installation.

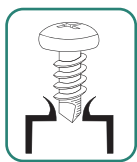
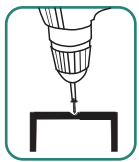
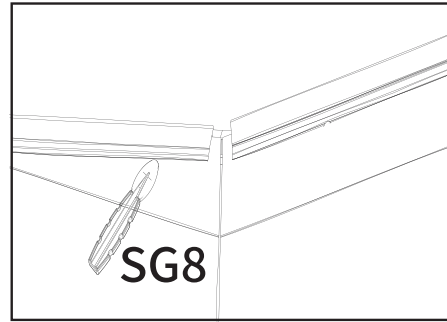
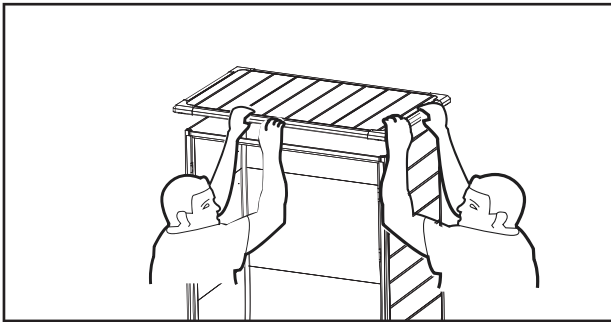

Please use Drill to predrill a hole at depth 1mm before screw.

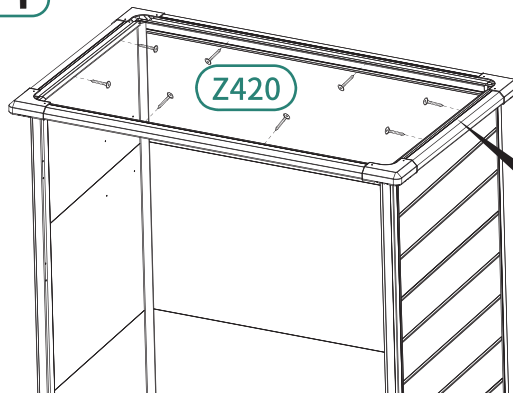

● Please note the nailing direction.

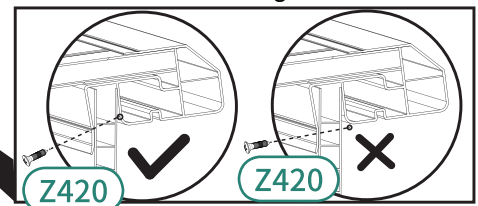

# Shelf assembly

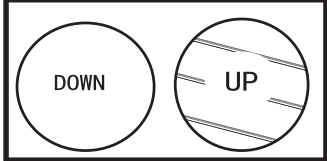
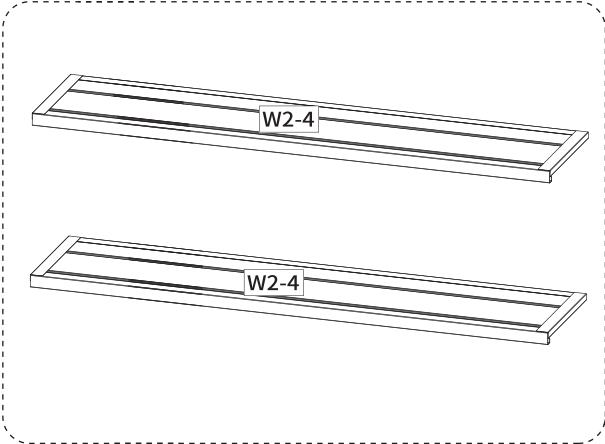

The stripes should be upwards

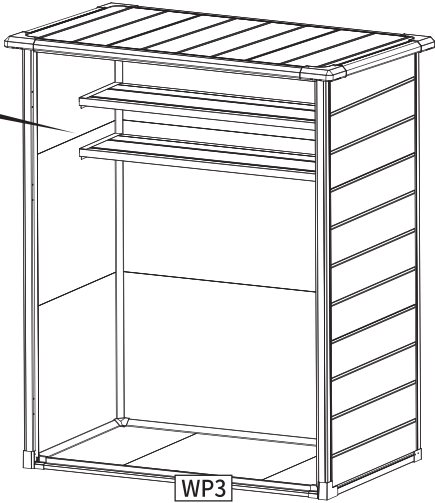
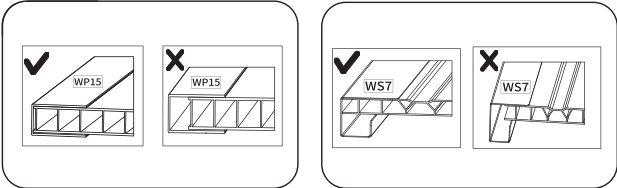

# 17



WS8 4pcs



ZW413 8pcs

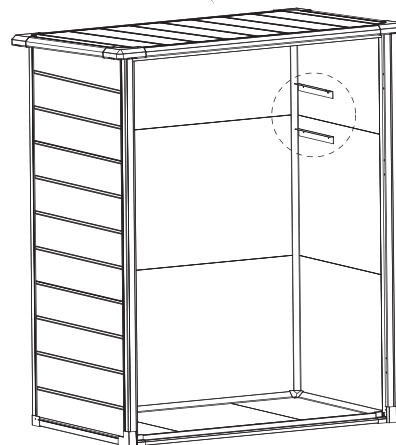
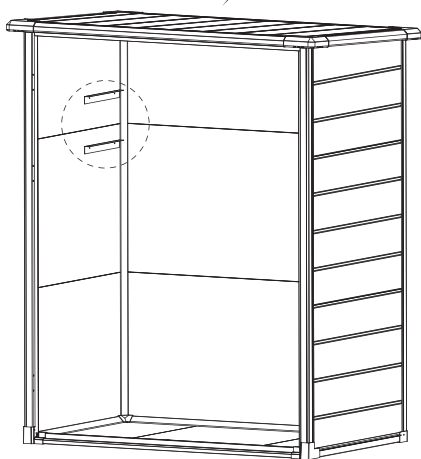
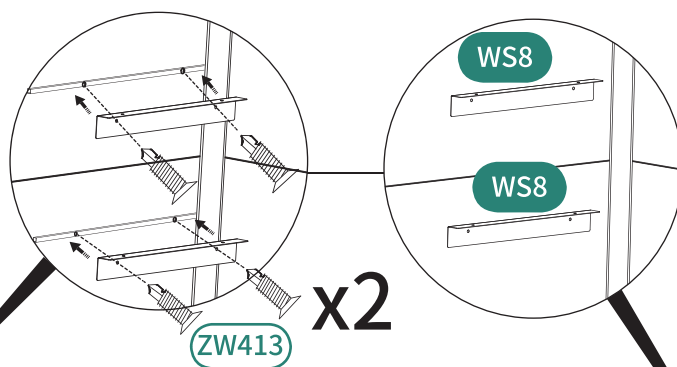

Screw position Note: Please align the round hole of the part with the round hole reserved on the plate surface and then screw it, they need to lock the corresponding square tube on the inside of the plate.

18

X2

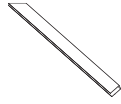

WP15 2pcs

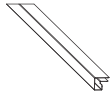

WS7 2pcs





WP14 2pcs

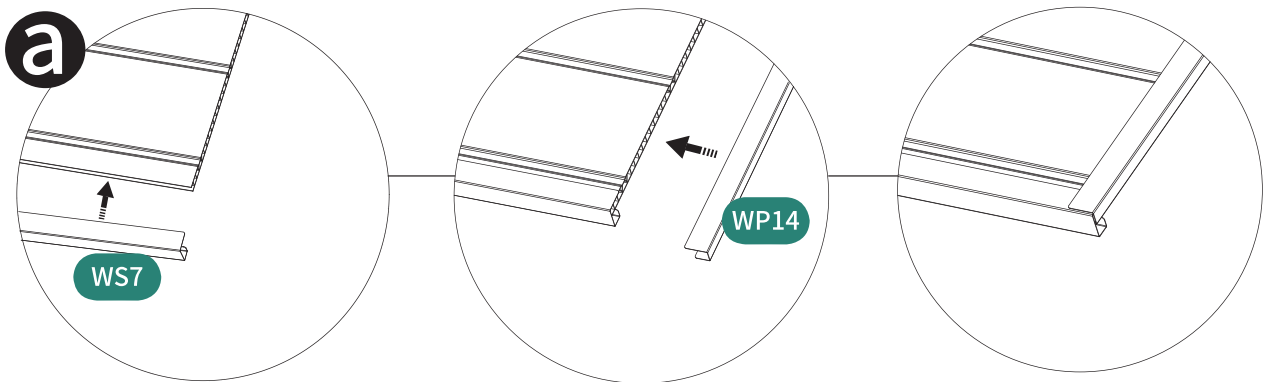
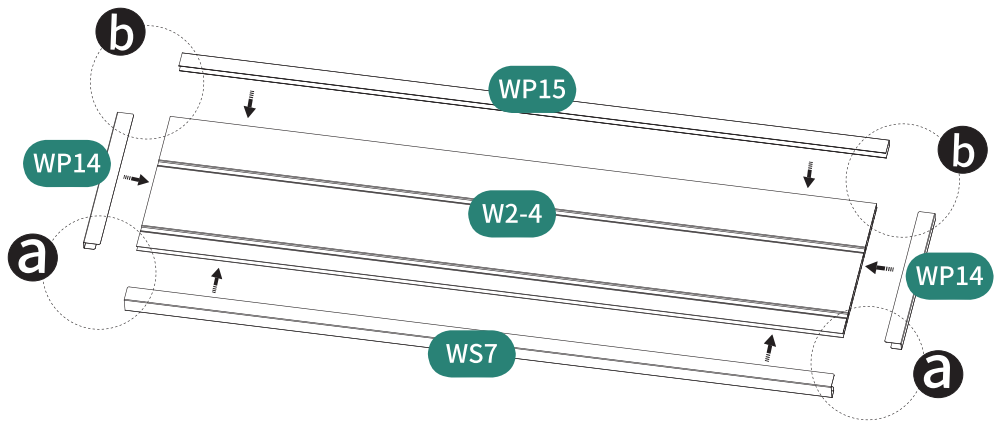
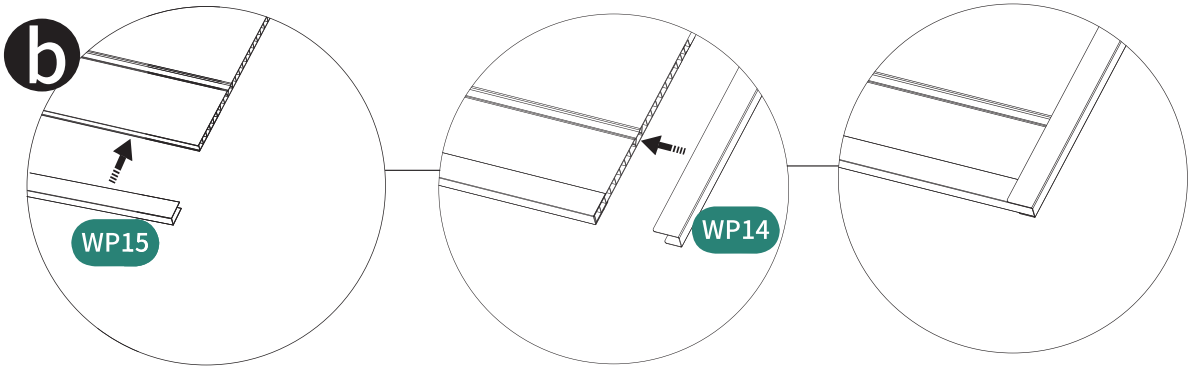

W2-4 2pcs



**19**  
**X2**

   
**ZW413** 10pcs **Z410** 2pcs

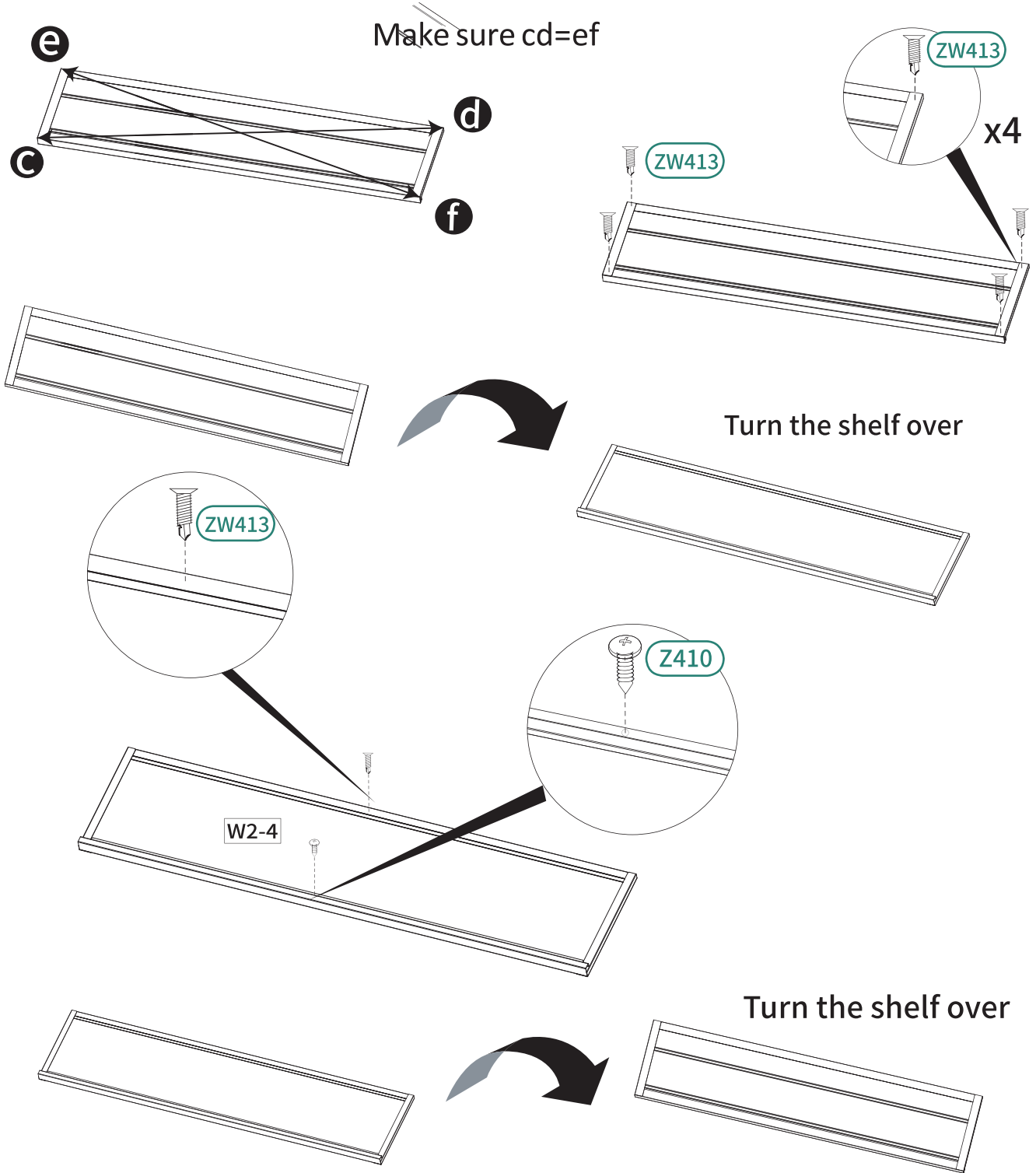

20



ZW413 8pcs



**a** Layer by layer shelf installation

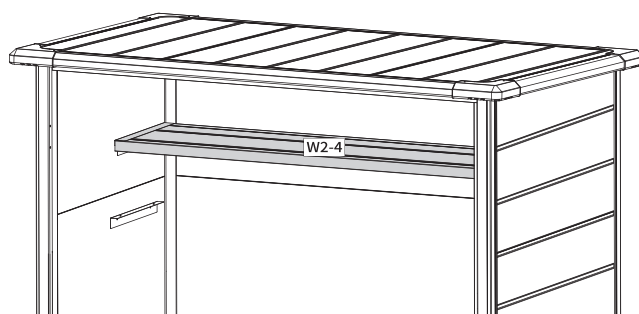

**b** Two-layer shelf installation

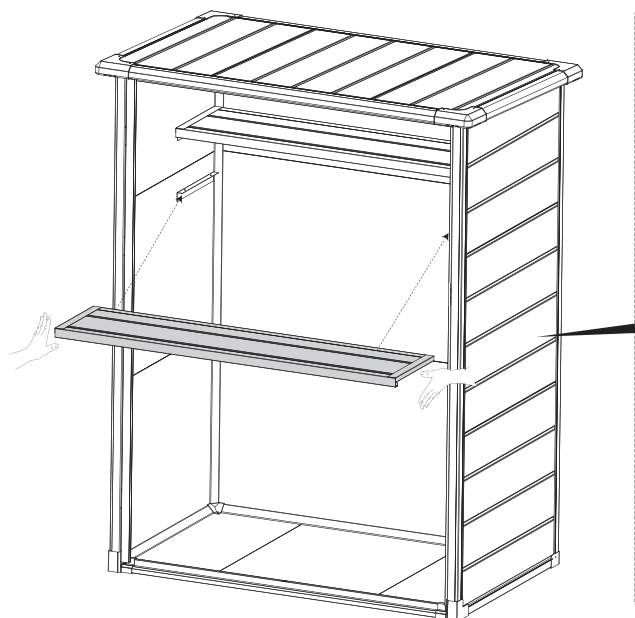



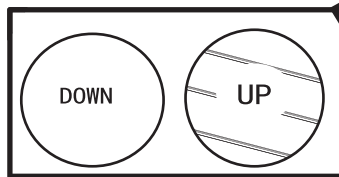
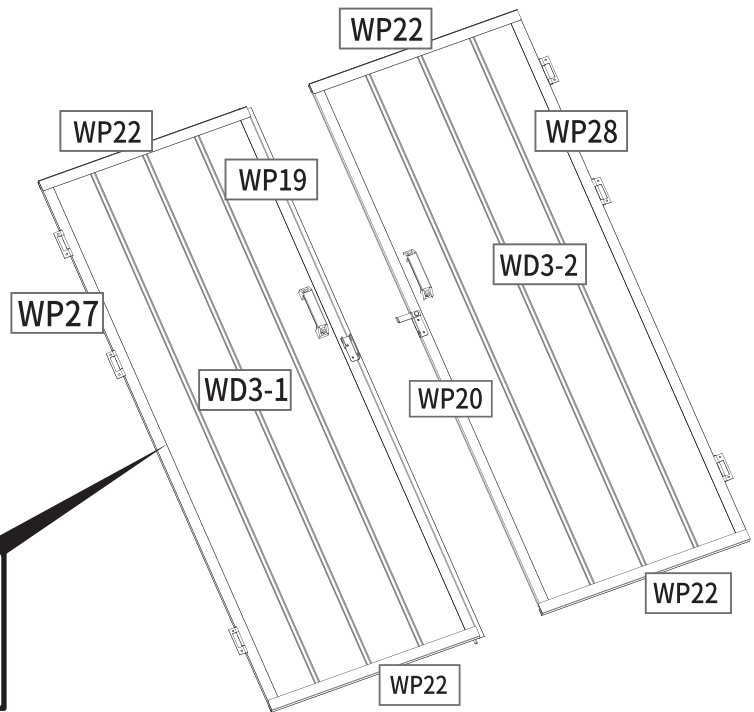



# DOORASSEMBLY



The stripes should be upwards

# 21

-  WD3-2 1pc
-  WD3-1 1pc
-  WP19 1pc
-  WP27 1pc
-  WP28 1pc
-  WP22 4pcs
-  WP20 1pc

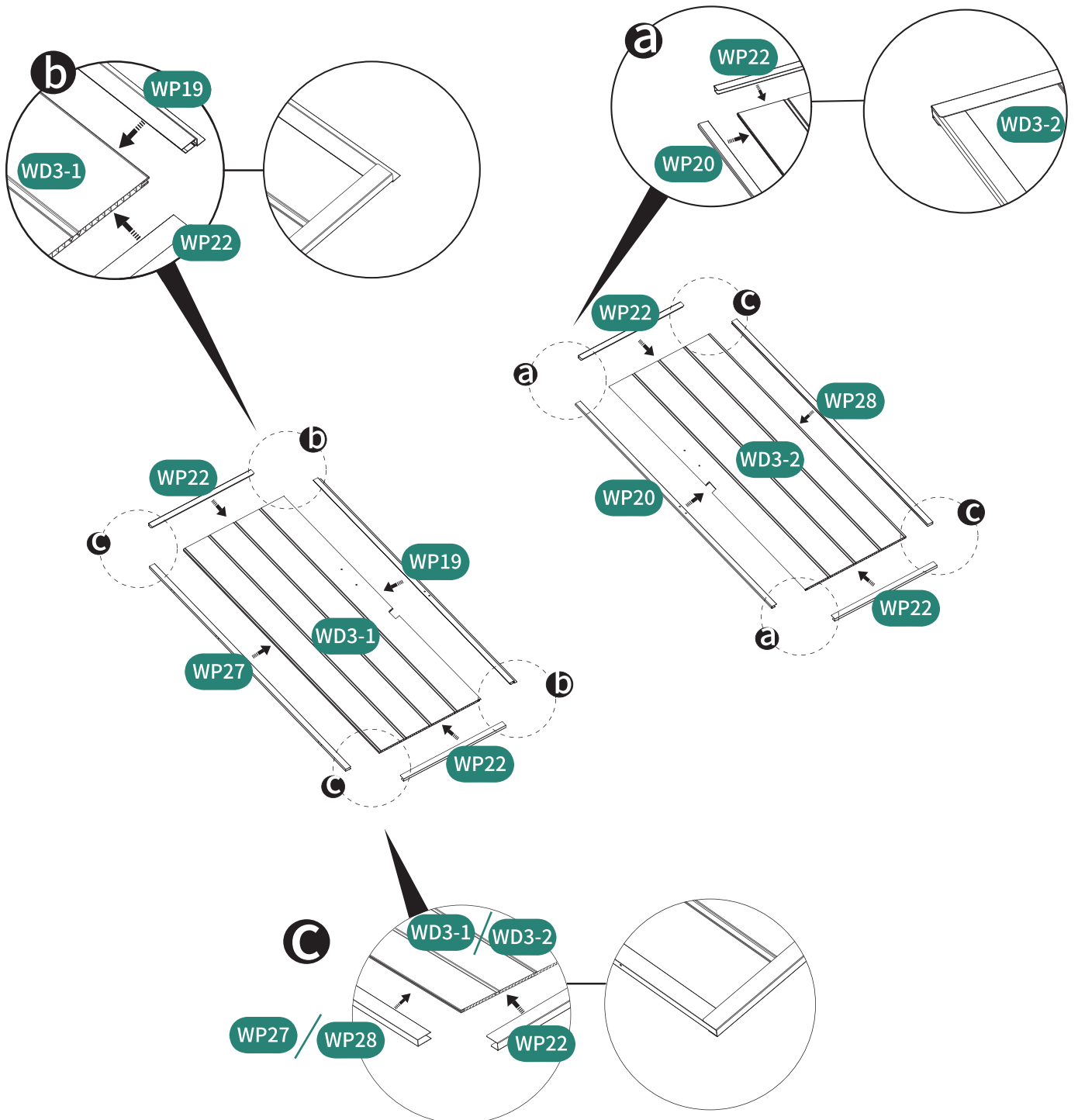

# 22



ZW413 12pcs

DC 2pcs

Z410 8pcs

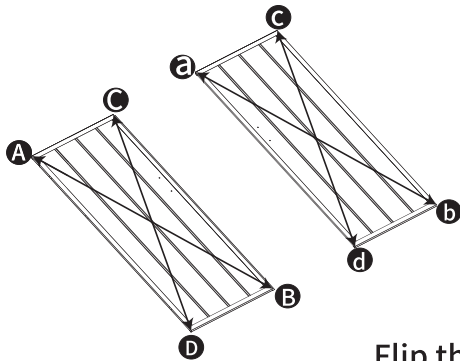

Ensure  $AB=CD$   $ab=cd$

Flip the door

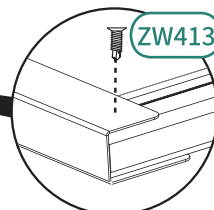
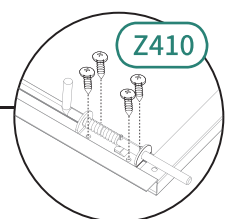
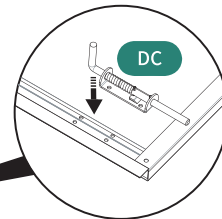
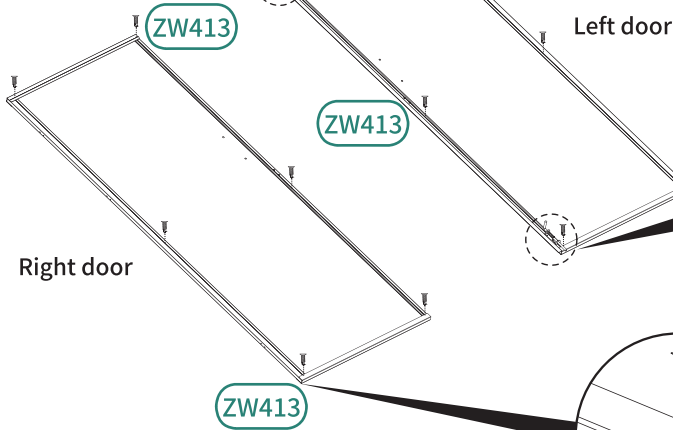
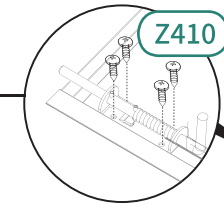
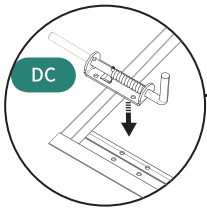
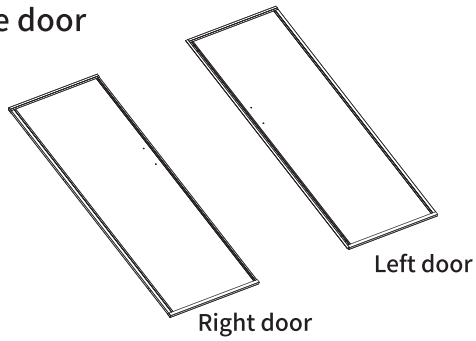
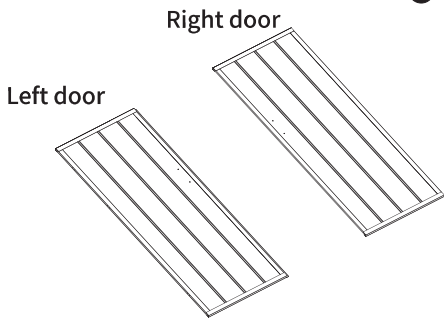

**23**

M05 6pcs      Z310 12pcs

Flip the door

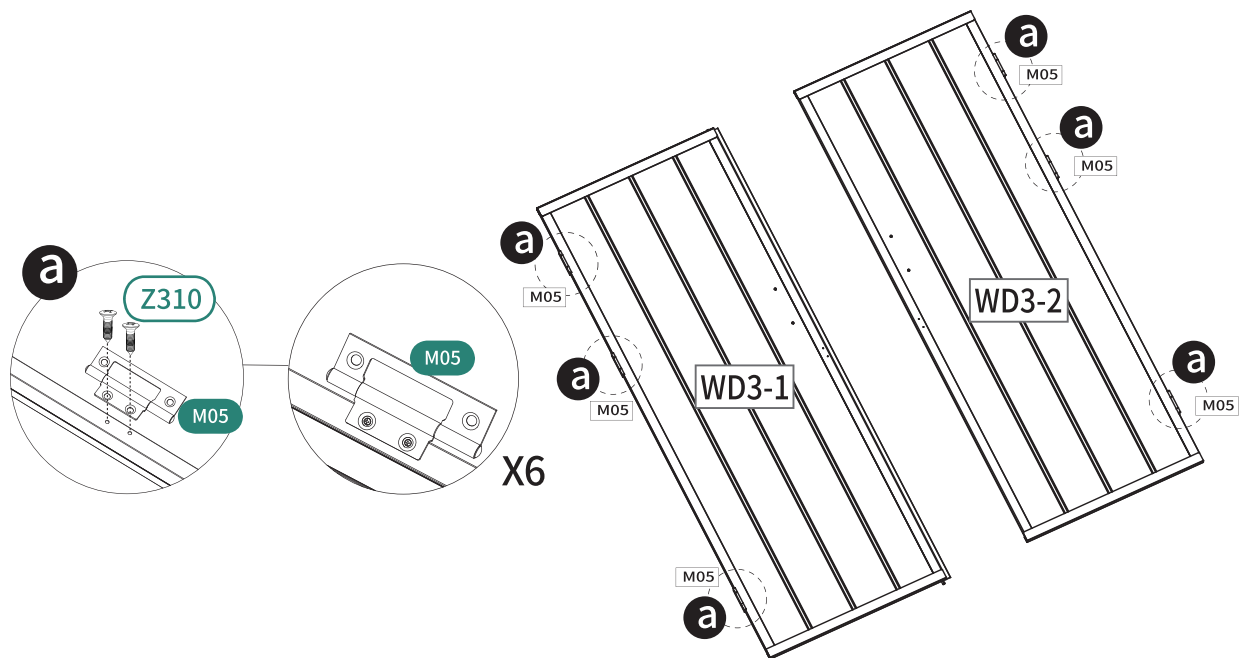
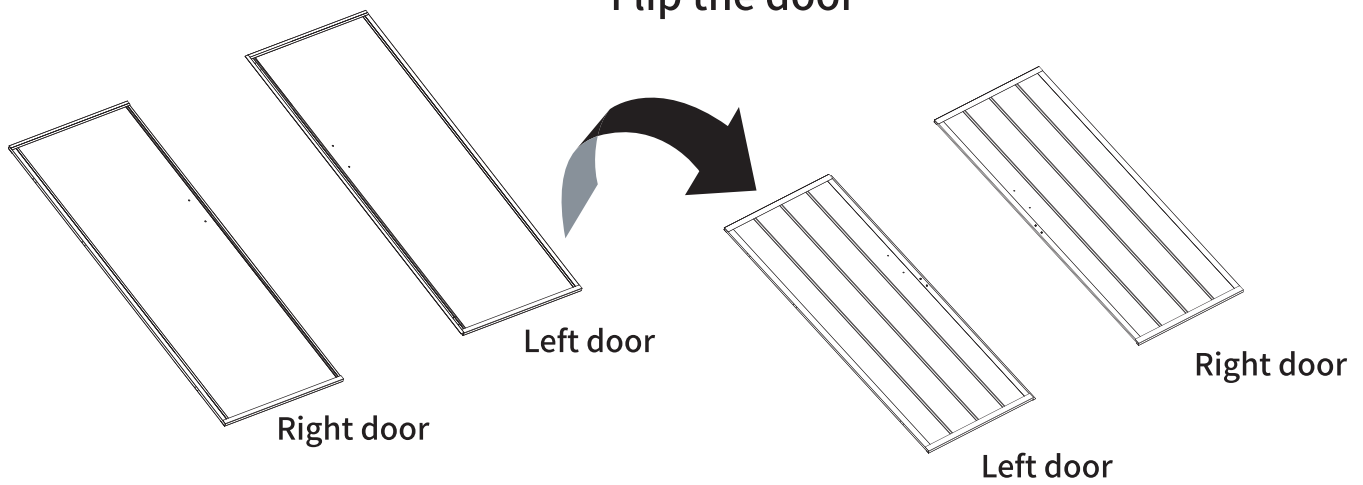

Please align the screw with the reserved hole and adjust it before tightening it.

**24**



Z310 12pcs

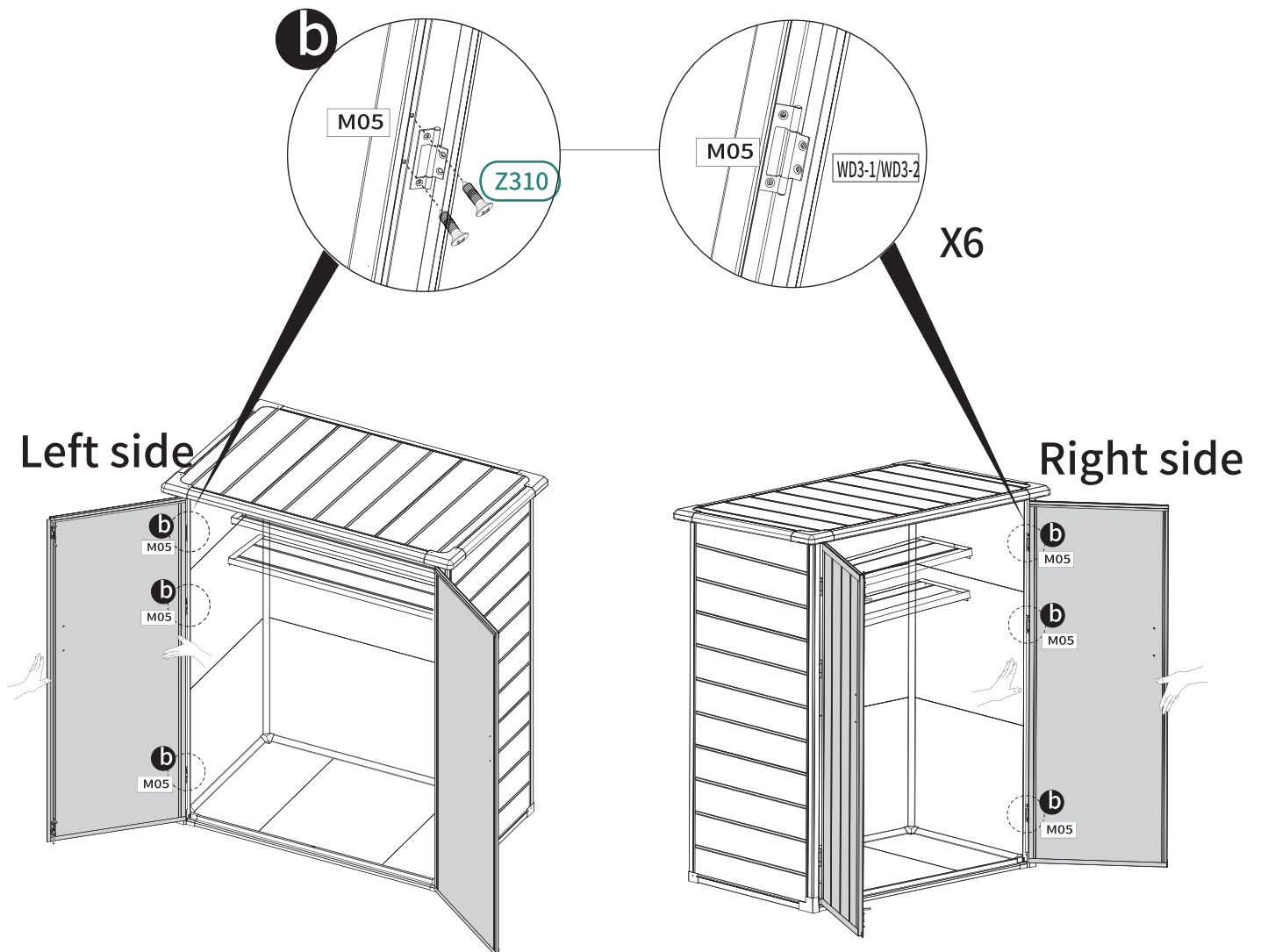

Please align the screw with the reserved hole and adjust it before tightening it.

# 25



M06 2pcs



RF10 4pcs



RF9 4pcs



LOCK-5 1pc



LOCK-6 1pc

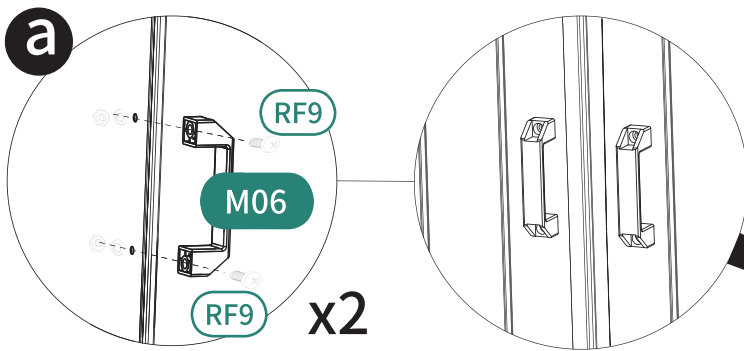

Please align the screw with the reserved hole and adjust it before tightening it.

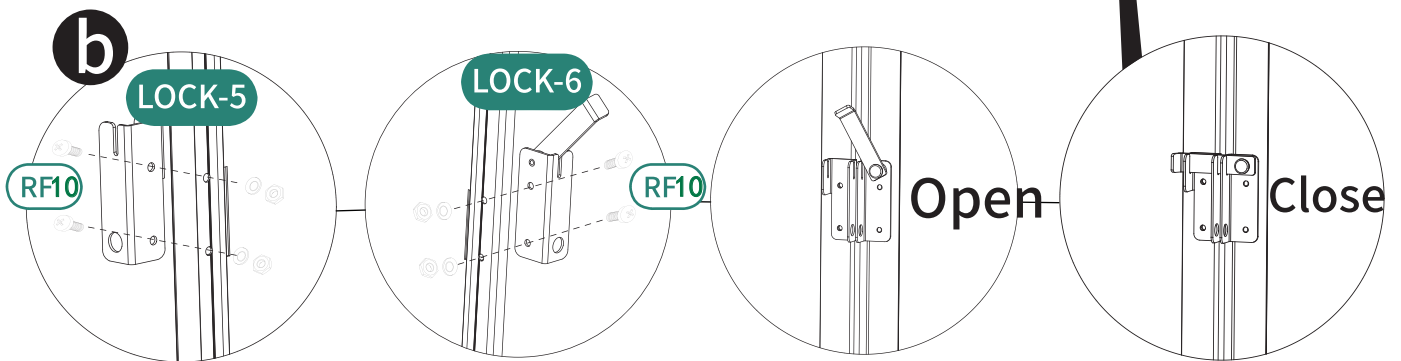
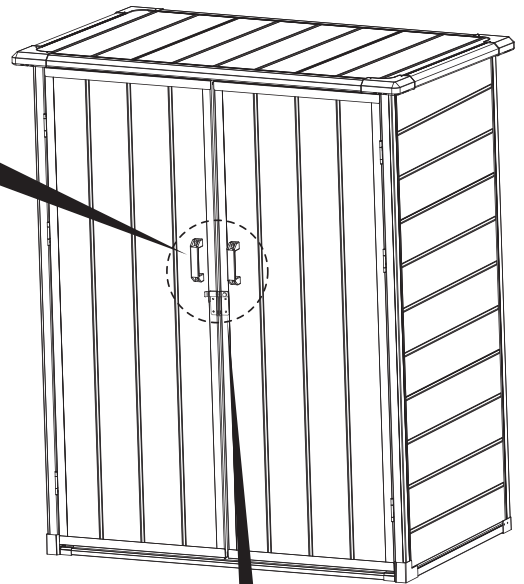

26



SG14 4pcs



Z420 4pcs

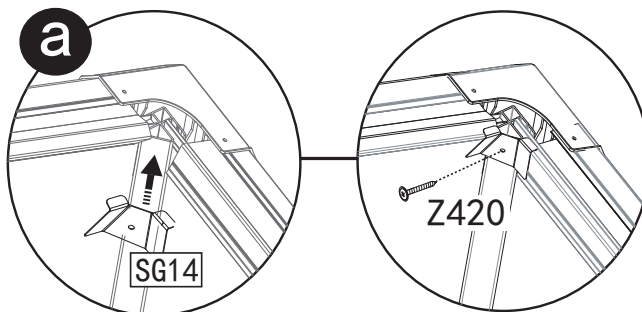
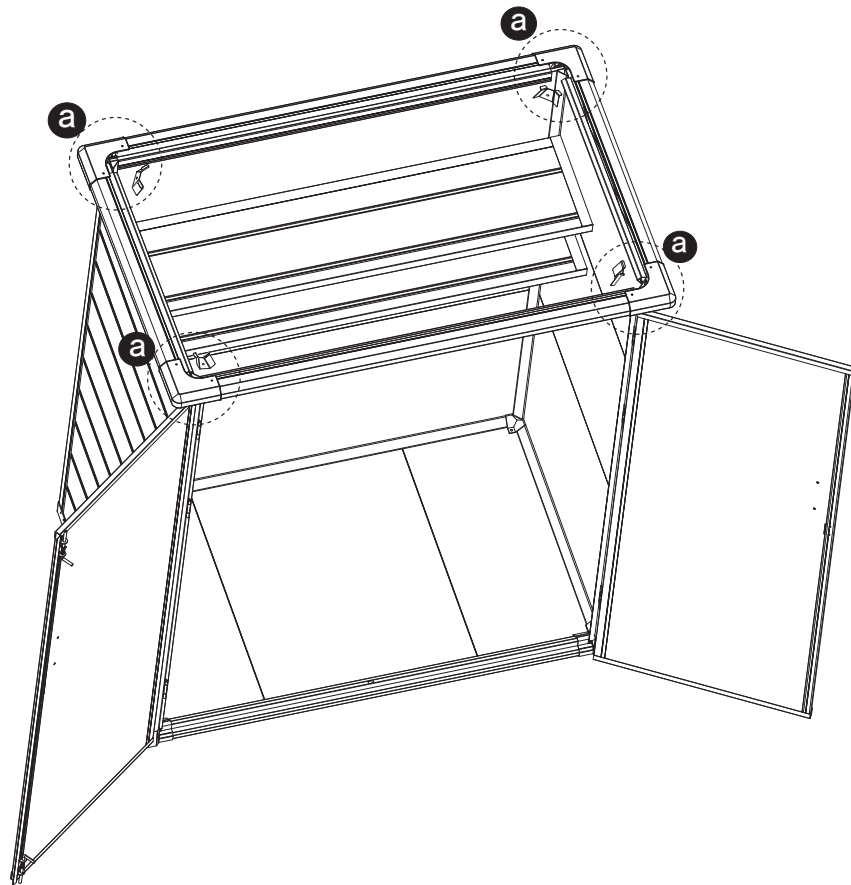

x4

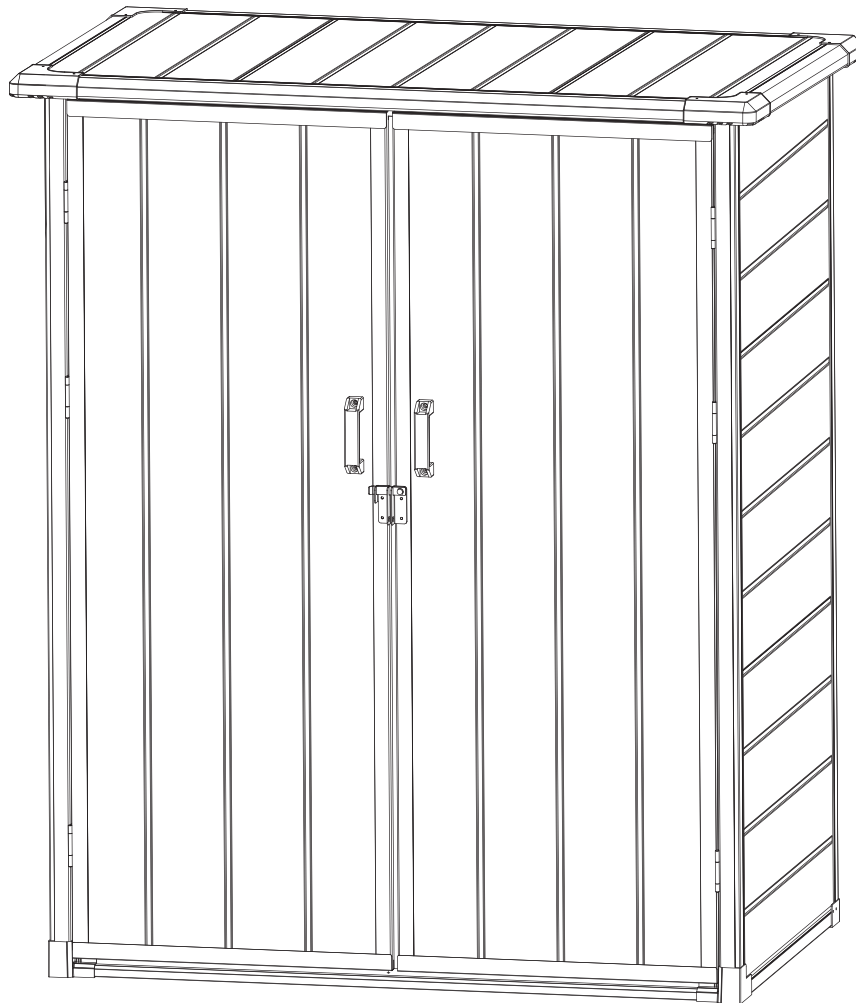

Installation Completed

Installation Abgeschlossen

Installation Complétée

Installazione Completata

Instalación Completada

# HELP CENTER



Inquiry



Assembly issue



Missing parts

If you encounter any difficulties during assembly, please contact us.

Wenn Sie während der Montage auf Schwierigkeiten stoßen, kontaktieren Sie uns bitte.

Si vous rencontrez des difficultés lors du montage, veuillez nous contacter.

Se incontri difficoltà durante il montaggio, ti preghiamo di contattarci.

Si encuentras alguna dificultad durante el ensamblaje, por favor contáctanos.

# DISCLAIMER

Manufacturer and seller expressly disclaim any and all liability for personal injury, property damage or loss, whether direct, indirect, or incidental, resulting from the incorrect attachment, improper use, inadequate maintenance, unapproved modification, or neglect of this product.

Der Hersteller und Verkäufer lehnen ausdrücklich jegliche Haftung für Personenschäden, Sachschäden oder Verluste ab, egal ob direkt, indirekt oder zufällig, die durch falsche Anbringung, unsachgemäßen Gebrauch, unzureichende Wartung, nicht genehmigte Änderungen oder Vernachlässigung dieses Produkts entstehen.

El fabricante y vendedor renuncian expresamente a toda responsabilidad por lesiones personales, daños materiales o pérdidas, ya sean directos, indirectos o incidentales, derivados de la incorrecta colocación, uso inadecuado, mantenimiento insuficiente, modificación no aprobada o negligencia de este producto.

Il produttore e il venditore declinano espressamente ogni responsabilità per lesioni personali, danni materiali o perdite, dirette, indirette o incidentali, derivanti dall'errato fissaggio, uso improprio, manutenzione inadeguata, modifica non autorizzata o negligenza di questo prodotto.

Le fabricant et le vendeur déclinent expressément toute responsabilité en cas de blessures corporelles, de dommages matériels ou de pertes, qu'ils soient directs, indirects ou accessoires, résultant de la fixation incorrecte, de l'utilisation inappropriée, de l'entretien insuffisant, de la modification non approuvée ou de la négligence de ce produit.