

## PIZZA OVEN USER MANUAL

For Model **PEL V**



**Size(W/ D/ H): 53\*46\*68CM/20.9\*18.1\*26.8INCH**

**Oven weight: 10.4KG/23.0LBS**

**Oven floor area: 0.11 m<sup>2</sup>/1.23 ft<sup>2</sup>**

---

**Important:** Retain these instructions for the future use.

---

**STEP 7** Assemble the firewood door to the stove with screw B and nut C.

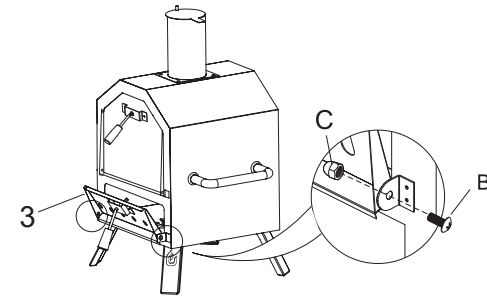

**STEP 8** Place pizza stone and grill net.

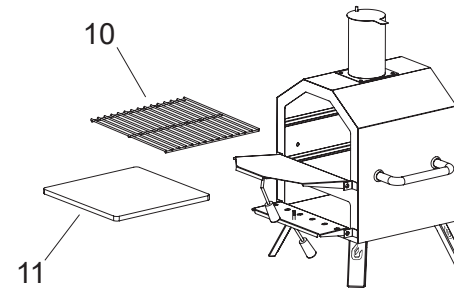

**STEP 9** Assemble the peel pan 14 with the wood handle 13 with 3 pcs screw G and nuts H.

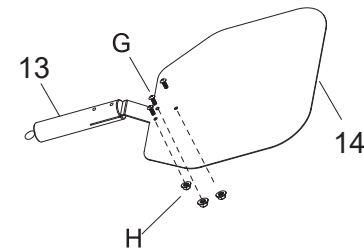

**STEP 4** Assemble the chimney 1 to the stove 7 with 4 screw A.

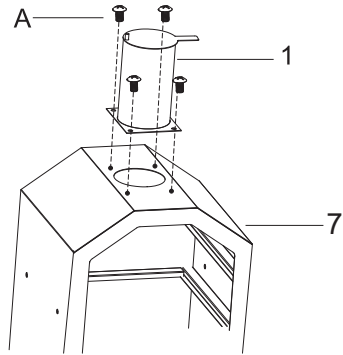

**STEP 5** Assemble the handle 9 and Handle washer 8 to the oven with screw A.

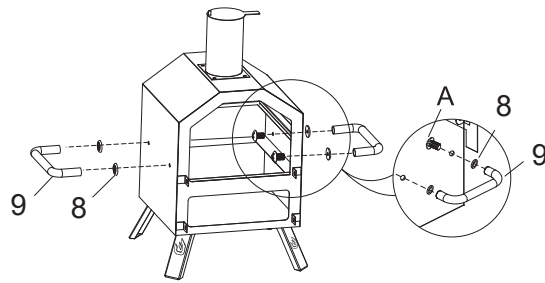

**STEP 6** Assemble the door to the oven with screw B and nut C.

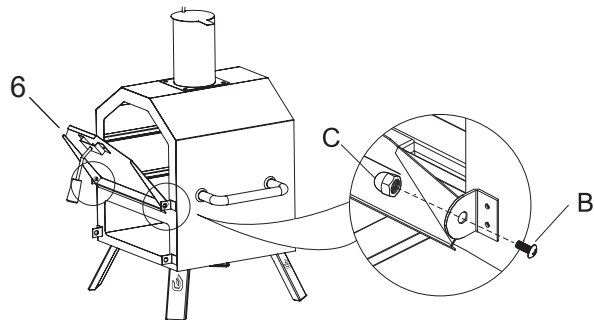

## Contents Index

Warranty.....	1
Safety Legal Disclaimer.....	1
Parts List.....	2
Assembly Instructions.....	3-5

## Warranty

**For any queries or assistance mail  
Promise to responded within 24 hours**



Customer Service  
pizzello2021@outlook.com

**These information will be required to offer under  
the 12 months warranty.**











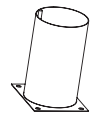
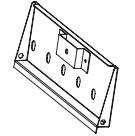

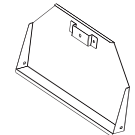

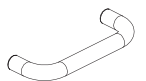
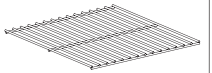

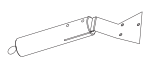
Product Model: .....  
Order ID: .....  
Purchase date: .....

## Safety Legal Disclaimer

All instructions and guidelines given in this manual must be followed without exception.

1. Pizzello is designed for outdoor use only. Must always be placed outdoors, away from structures and never inside a building or a garage or in proximity to any enclosed area. Place your OVEN on a sturdy, level, stable and non-flammable surface and keep it clear and free from flammable or combustible materials, gasoline and other flammable vapours and liquids.
2. Be aware of any local laws or regulations that may specify a required distance between outdoor cookers and any structures, or that may limit outdoor flame of any type during drought or hazard periods.
3. Do not install or use your Pizzello in or on boats or recreational vehicles.
4. Do not use your Pizzello in high winds.
5. Your Pizzello is not intended to, and should never be used as a heater.
6. Toxic fumes can accumulate and may cause asphyxiation.
7. Flames can blow outside of the metal enclosure:
  - a. At the back where the fire is;
  - b. From the top of the hatch when the lid is opened;
  - c. From the front of the oven when you open the door; or d. from the top of the chimney.
8. Please keep away from the Pizzello's openings and warn others around you.
9. Improper installation, adjustment, alteration, service or maintenance of your Pizzello may cause injury or property damage. Therefore, do not use your Pizzello unless it is completely assembled and all parts are securely fastened and tightened.
10. Your Pizzello should be inspected on a regular basis.

## Parts List

1.  Cap 1PC	2.  Chimney 1PC	3.  Firewood door 1PC	4.  Door handle 2PCS
5.  Retainer 2PCS	6.  Door 1PC	7.  Oven 1PC	8.  Handle washer 4PCS
9.  Handle 2PCS	10.  Grill 1PC	11.  Pizza stone 1PC	12.  Spring 1PC
13.  Wood handle 1PC	14.  Peel pan 1PC	15.  Cover 1PC	
A.  Screw M6*16 8PCS	B.  Stainless steel screw M6*16 4PCS	C.  Nut M6 5PCS	D.  Nut M6 2PCS
E.  Nut M6 2PCS	F.  Washer 2PCS	G.  Screw M4*8 3PCS	H.  Nut M4 3PCS

### Note

Before the whole item assembly, you need to assemble the STEP 1, 2, 3 at first. Please follow below instruction. Contact us if item damaged or defective during the transmission.

## Assembly Instructions

**STEP 1** Assemble chimney (2) and cap (1) with screw nut C and spring 12.

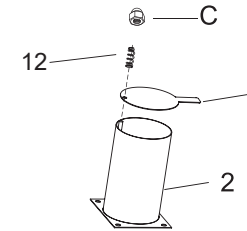

**STEP 2** Assemble firewood door (3) and door handle (4) with washer F and screw nut D. Then put on the retainer (5) and fix it with screw nut E.

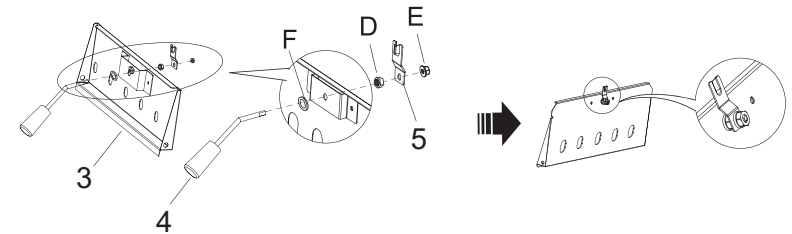

**STEP 3** Assemble door (6) and door handle (4) with washer F and screw nut D. Then put on the retainer (5) and fix it with screw nut E.

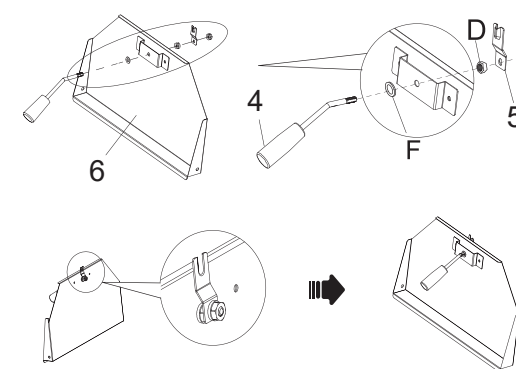

## TIPS:How to clean firewood ash?

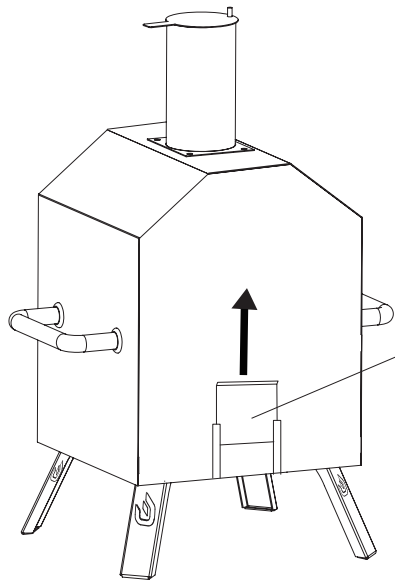

Pull up the baffle behind the stove and clean through the ash catcher

## Top Reasons Why Pizza Stones Crack

1. PUTTING A COLD BAKING STONE INTO A HOT OVEN
2. ALLOWING MOISTURE INTO THE BAKING STONE
3. PLACING COOL OR COLD FOOD ONTO THE BAKING STONE
4. HANDLING THE STONE TOO MUCH
5. REMOVING THE STONE TOO SOON FROM A HOT OVEN
6. USING TOO MUCH HEAT

### How To Prevent Your Pizza Stone From Cracking In The Future

- Maintain your stone in your oven at all times. If you such as a pretty looking rock, cover with aluminum foil so drips from other things don't discolor it.
- Always place a rock into a cool stove as well as do a long pre-heat.
- Decrease handling. Moving in and out of the stove can cause cracking.
- Stay clear of cleaning or oiling a stone. The moisture can create it to split.
- Wait until rock is entirely chilly before removing it from oven.
- Don't place icy pizzas on your pizza stone.
- Utilize a folded up towel and also place on the counter prior to you take the rock out of the stove, so the counter will not send your rock right into "thermal shock".