

*Thank you for your purchase!*

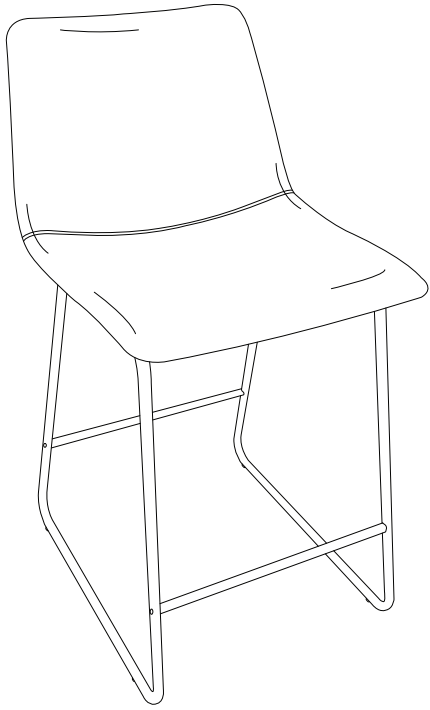

## 24 Inch LeatherSoft Counter Height Stools Set of 2

### ASSEMBLY INSTRUCTIONS

#### **Before You Begin:**

Please identify all component parts and hardware pieces required before you begin. Carefully remove all of the components from the packaging and set aside for assembly. Assemble on a soft surface to prevent scratching during assembly.

#### **Caution:**

Tighten all components securely before use. Failure to do so may result in personal injury.

DO NOT use any sharp objects to open plastic wrapped components as damage to product or components may result.

#### **Warning:**

**CHOKING HAZARD** - Small Parts. Adult Assembly Required.





#### **DO NOT ALLOW CHILDREN TO CLIMB ON FURNITURE**

Serious or fatal injuries can occur from furniture tipping over. You must install Tipping Restraint Hardware (where included) to help prevent the unit from tipping and causing accidental injury, instability, death or damage. The tipping restraint is intended only as a safety measure, it is not a substitute for proper adult supervision.

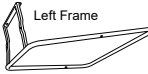
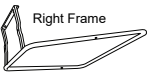
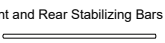
To help prevent furniture from tipping over it must be permanently attached to the wall. Anti-Tip Safety Wall Straps suitable for the unit weight and wall materials (if not included) should be purchased and installed.

# PARTS

A	 Seat	1PC
B	 Left Frame	1PC
C	 Right Frame	1PC
D	 Front and Rear Stabilizing Bars	2PCS

1	 Long Bolt	4PCS
2	 Short Bolt	2PCS
3	 Medium Bolt	4PCS
4	 Allen Wrench	1PC

## STEP 1

**STEP 1:** Attach the Right Frame (Part C) to the Left Frame (Part B) using (2) Short Bolts (Part 2). Attach Front and Rear Stability Bars (Part D) to the Left and Right Frames using (4) Long Bolts (Part 1). Tighten all bolts with Allen Wrench (Part 4) and tighten pre-assembled floor glides on the bottom of the Left and Right Frames.

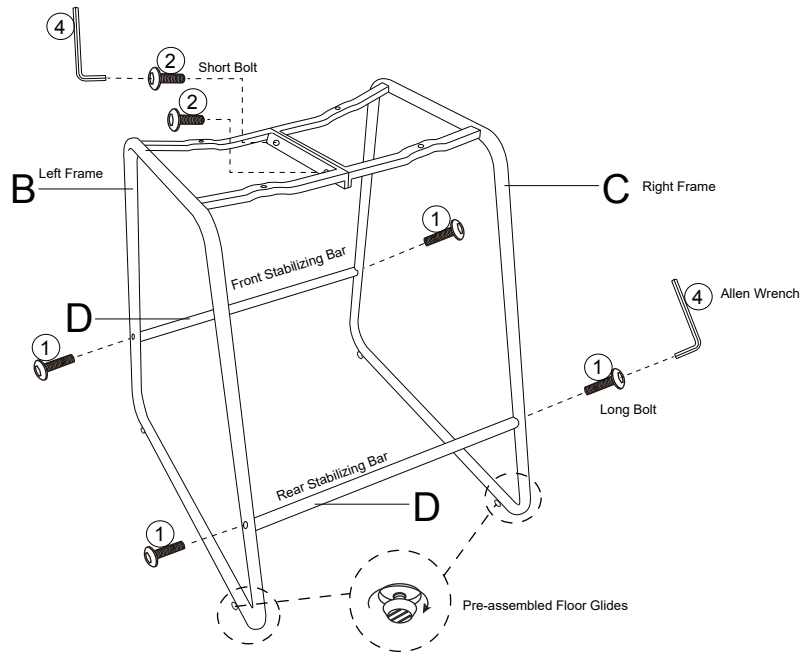

## STEP 2

**STEP 2:** Turn Seat upside down on a clean, smooth surface and attach frame to the underside of seat using (4) Medium Bolts (Part 3) and tighten with the Allen Wrench (Part 4).

**Note:** Ensure the seat bracket marked front (see diagram) is facing the front of the chair.

