

Assembly Instructions

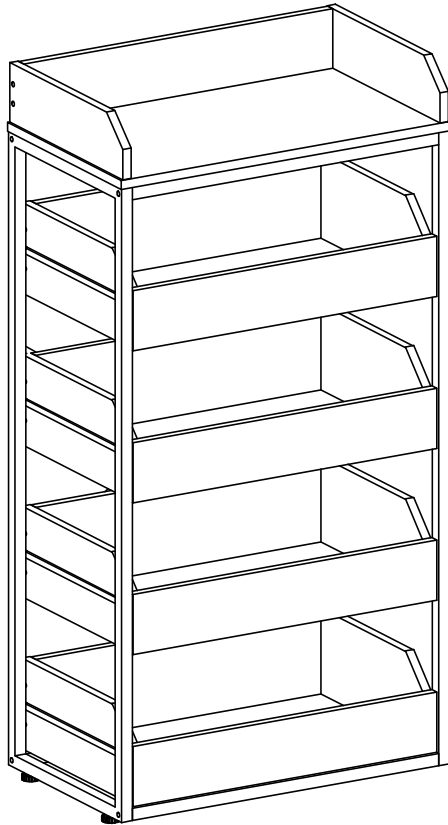

Storage Dresser

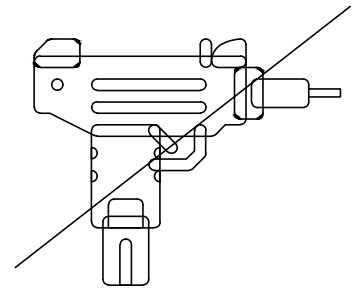
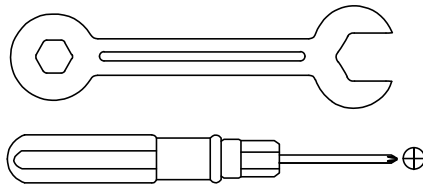
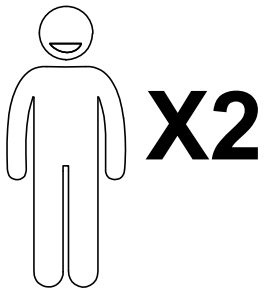

We recommend using hand tools for assembly.

If an electric screwdriver is used, reduce power and torque to avoid damage to the product.

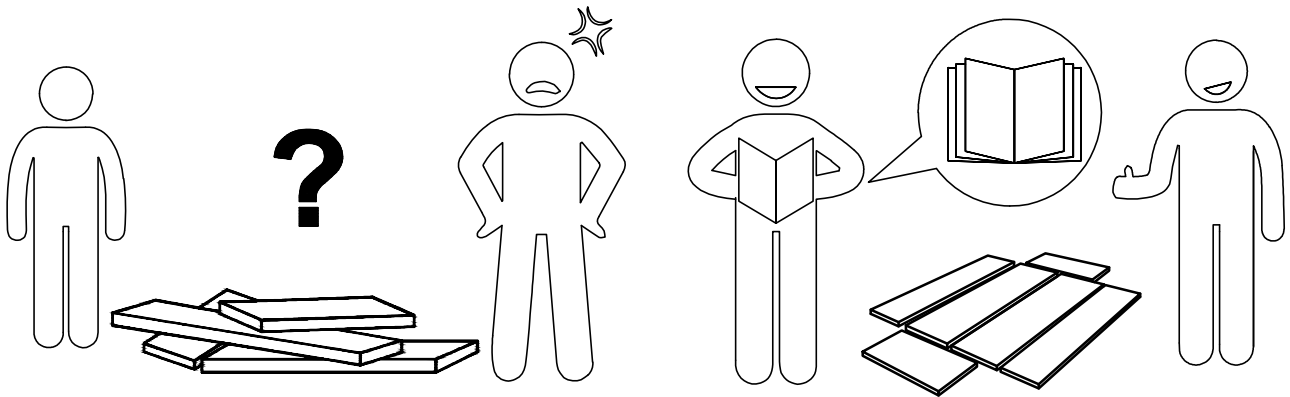

Install the Anti-Tip Straps

Using the anti-tip straps can reduce the risk of tipping over, but can not eliminate it.

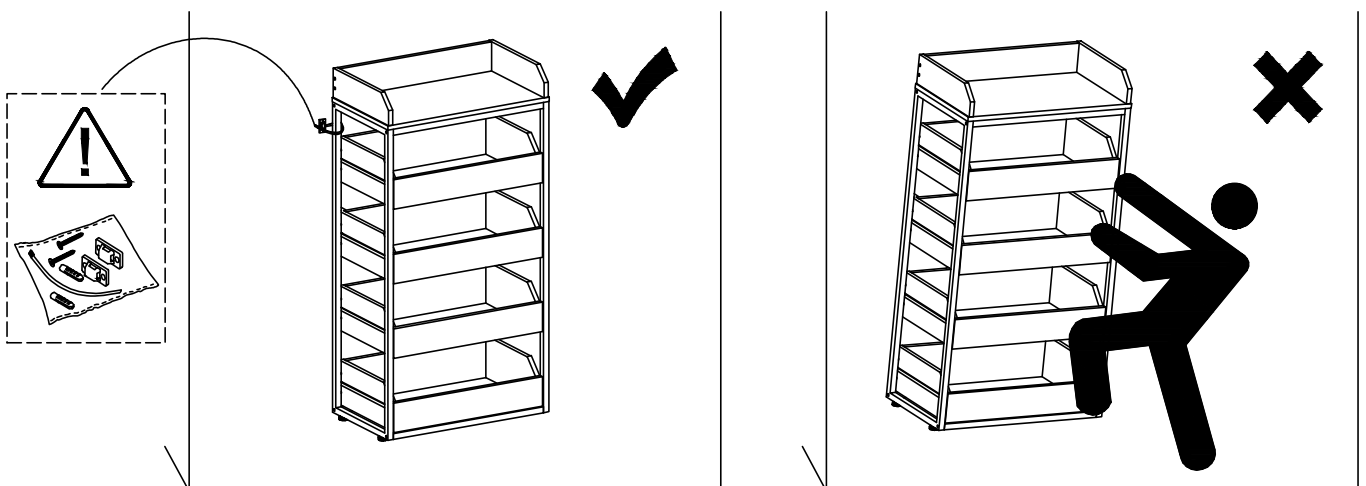

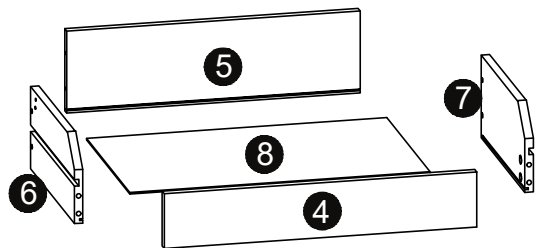
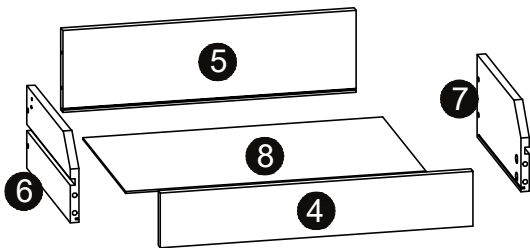
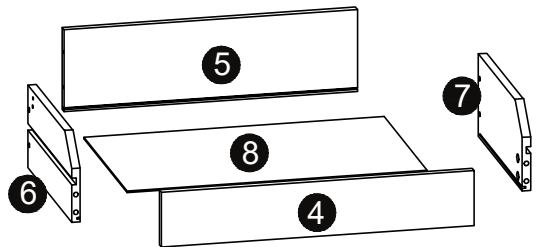
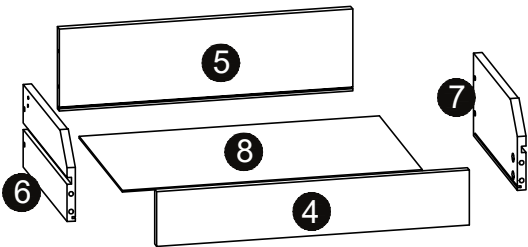
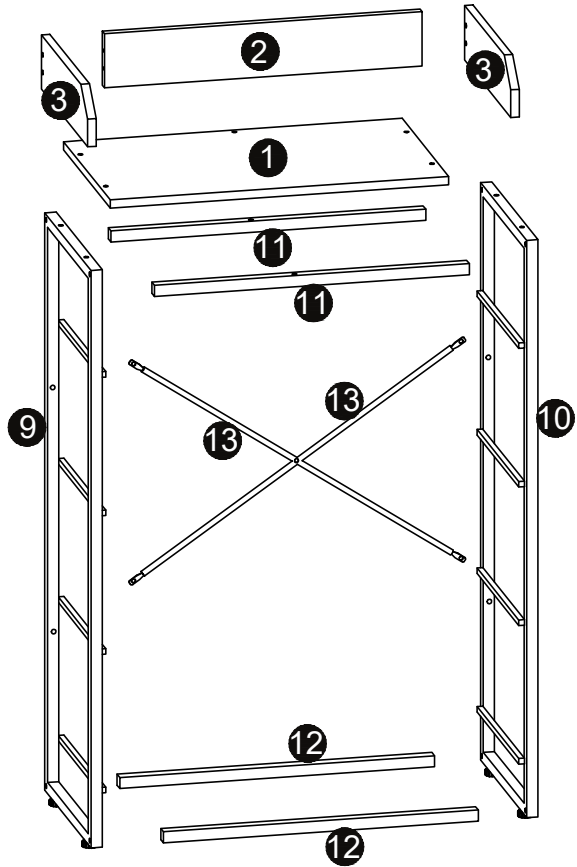







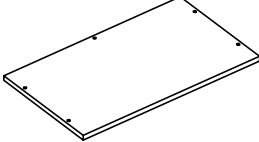
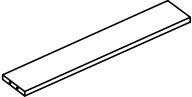
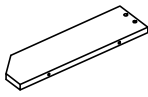
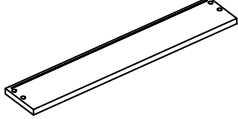
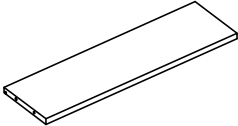
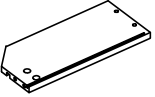
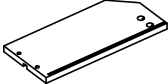
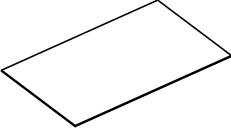
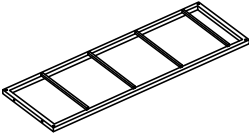
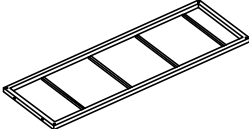
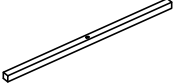





⚠ Caution

Make sure all parts are included. Most board parts are labeled or stamped on the raw edge. Contact us for a free replacement if you encounter any damaged or missing parts.

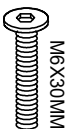
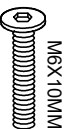
Parts List

 1 1 pc	 2 1 pc	 3 2 pcs	 4 4 pcs	 5 4 pcs
 6 4 pcs	 7 4 pcs	 8 4 pcs	 9 1 pc	 10 1 pc
 11 2 pcs	 12 2 pcs	 13 2 pcs		

Hardware List

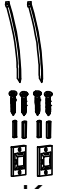
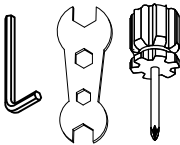
 A 5 pcs	 B 20 pcs	 C 8 pcs	 D 5 pcs	 E 1 pc	 F 16 pcs	 G 4 pcs
 H 5 pcs	 I 8 pcs	 J 16 pcs	 K 1 pc			

Installation of Cams and Pins

Screw the pin into the hole. To set the cams correctly, ensure that the arrow on the cam is opening to the hole of the pin it is locking. Lock the cam by turning the cam head with a screwdriver until it is tightened. Please do not use an electric screwdriver to assemble the unit.

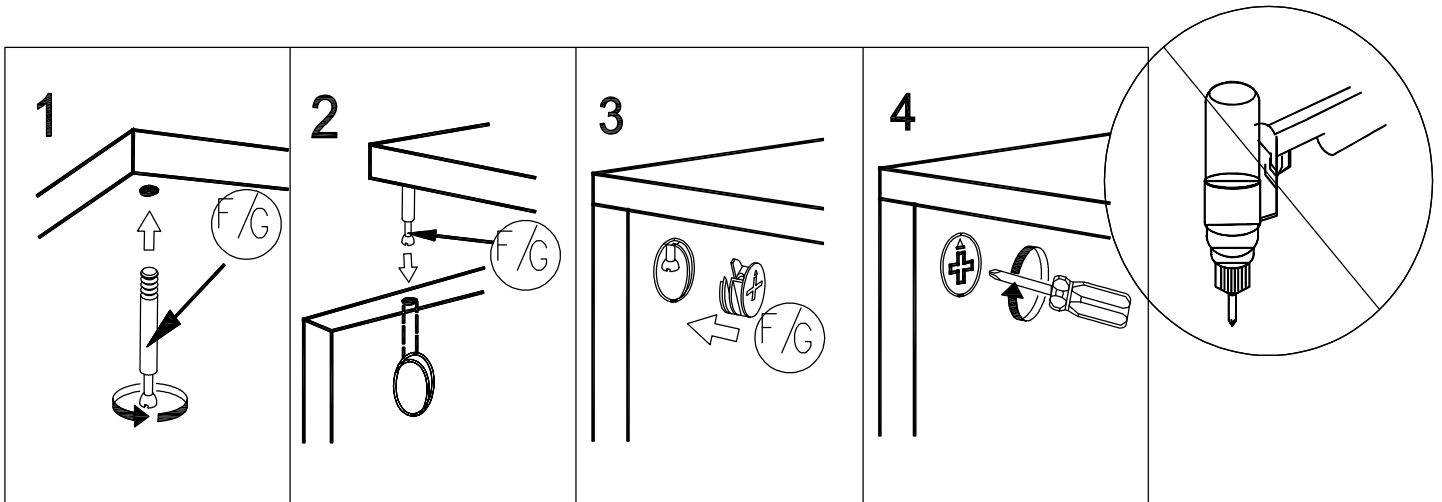

Read each step carefully before starting. It is very important that each step of instruction is performed in the correct order. If these steps are not followed in sequence, assembly difficulties will occur.

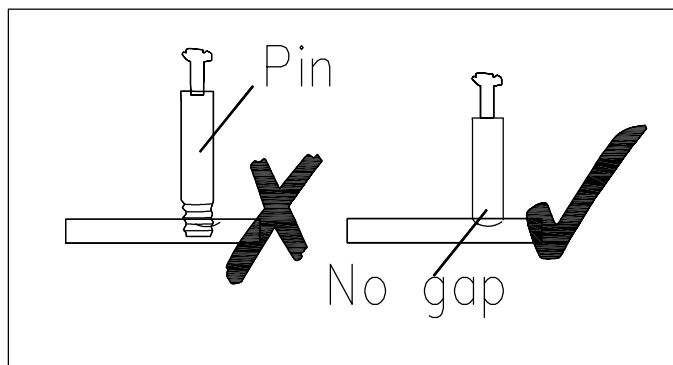

1

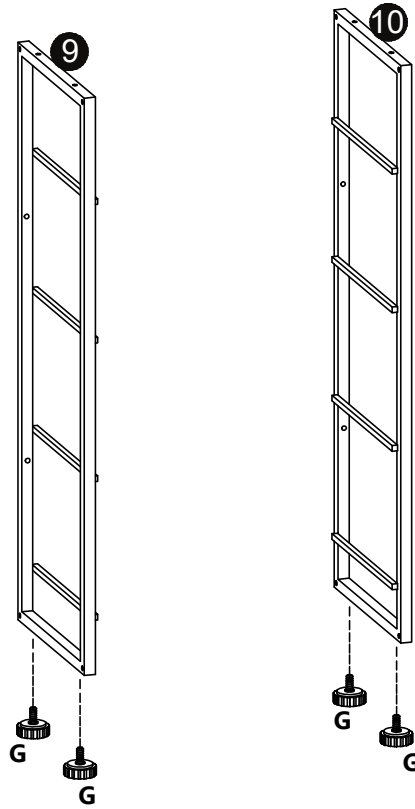

G
4 pcs

2

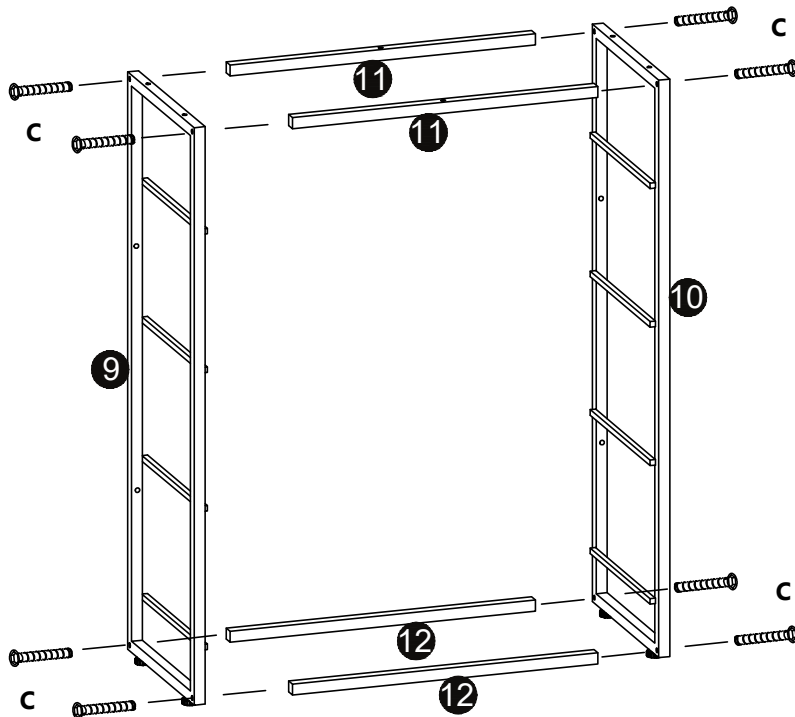

C
8 pcs

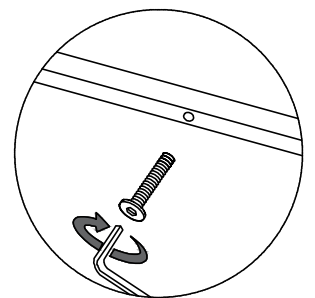

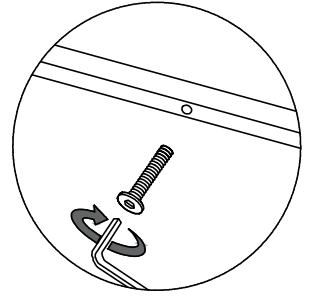
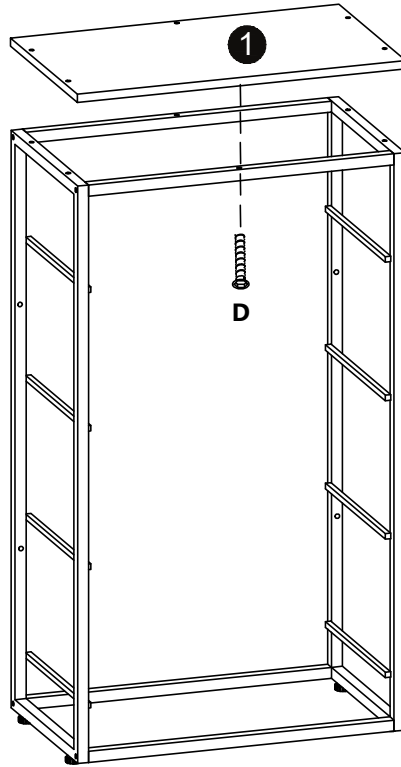

3



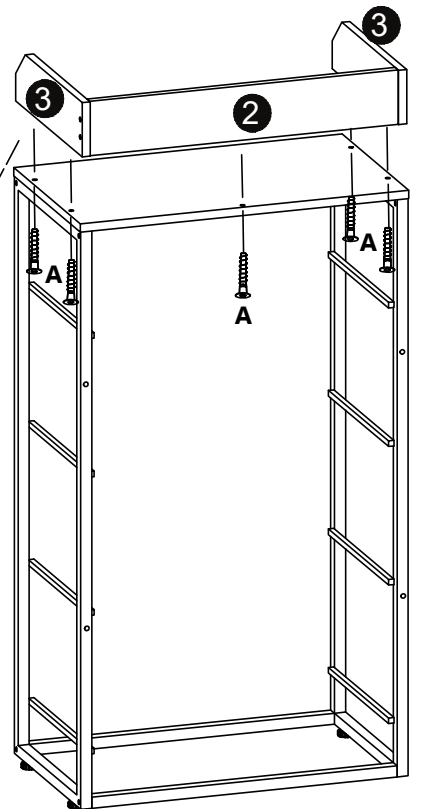
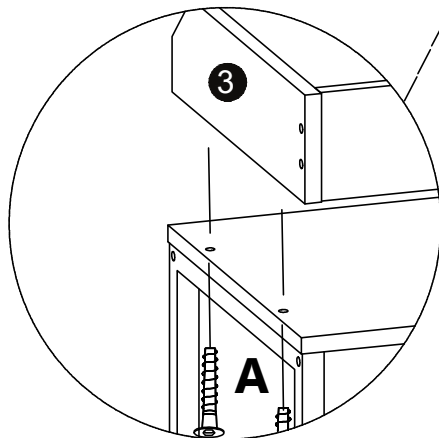
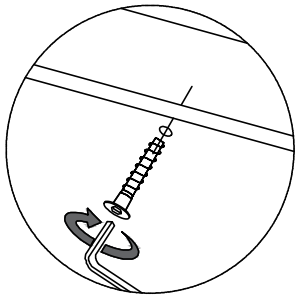
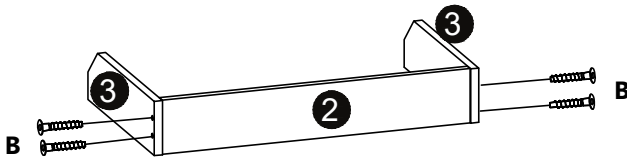

D
1 pc

4







B
4 pcs

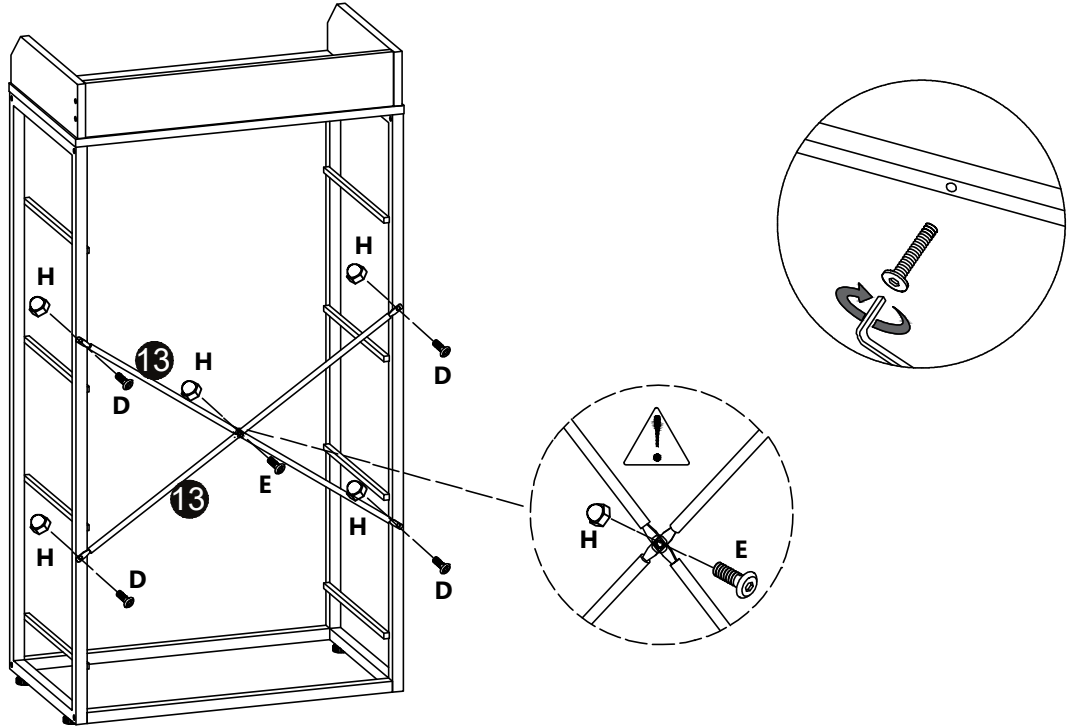

A
5 pcs



5

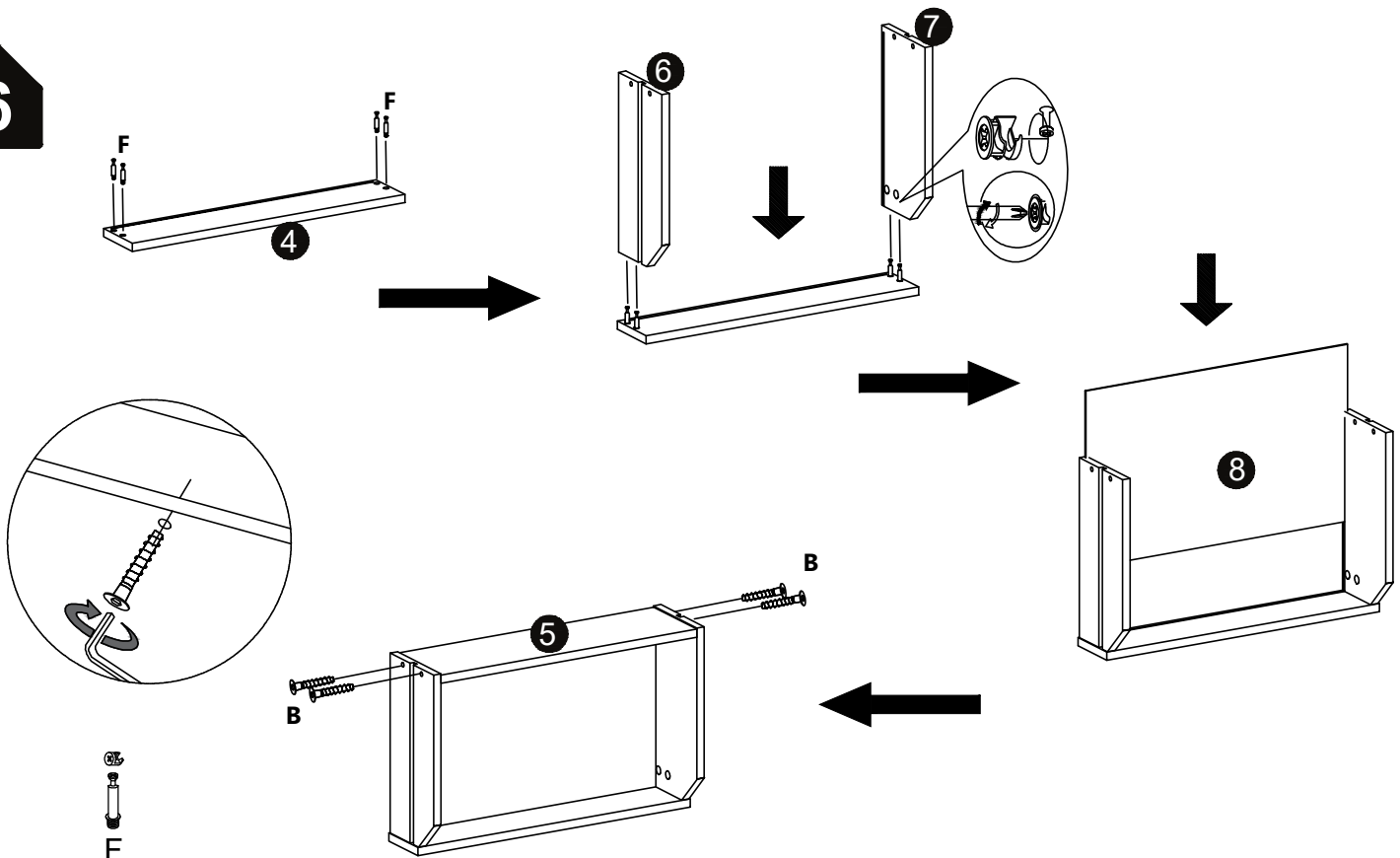

-  H
5 pcs
-  E
1 pc
-  D
4 pcs

6



-  B
16 pcs
-  F
16 pcs

7

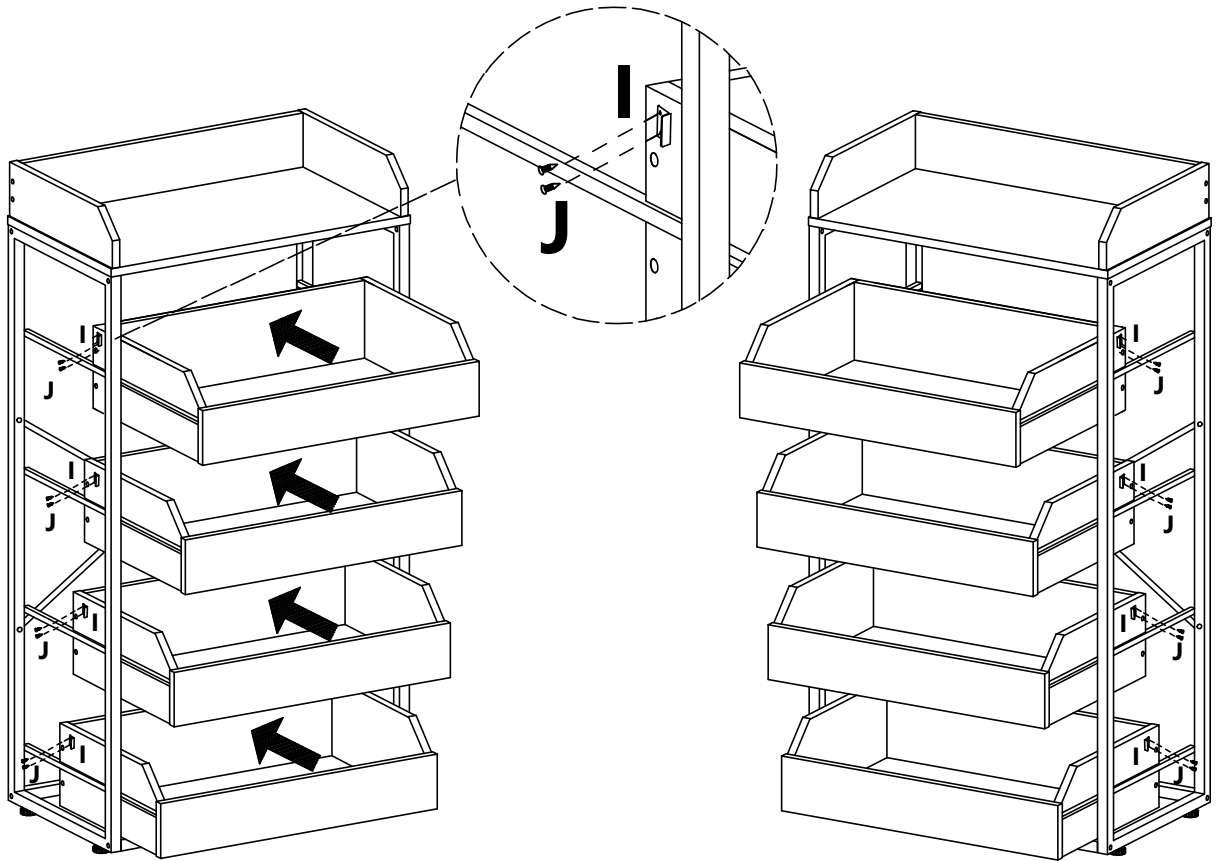

J
16 pcs

I
8 pcs

8

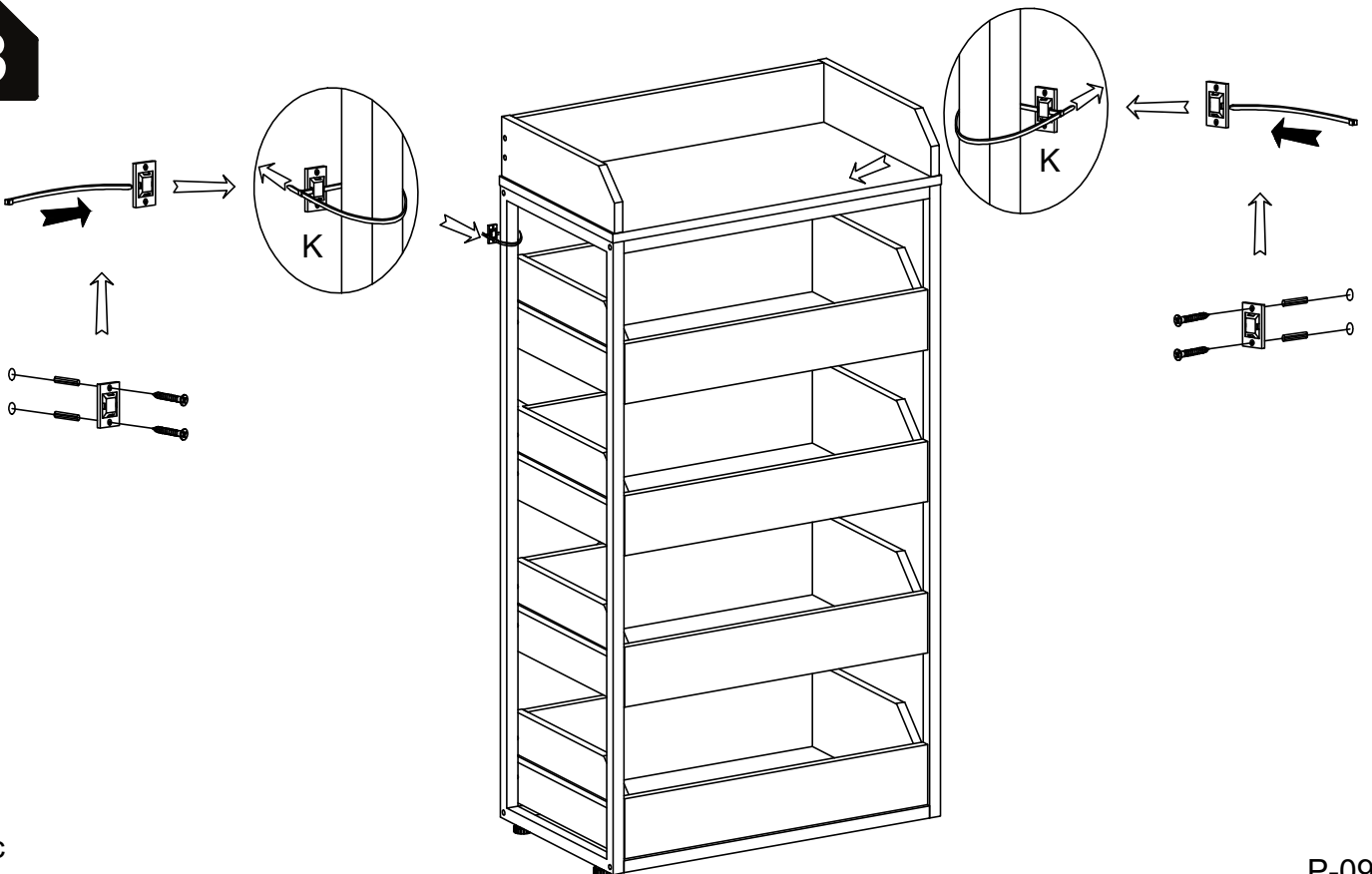

K
1 pc

Thank you for your support!

