

ITEM #: RVL-OW7648-1

Kira
Home

IMPORTANT SAFETY INSTRUCTIONS

- To avoid injury or damage, mount only on a surface that is sturdy.
- To avoid electric shock, make sure the electricity is turned off at the main circuit breaker panel. If you are replacing an existing fixture, turn off the following in order: fixture, wall switch, and main fuse or breaker box.
Note: Some types of fuses must be unscrewed to shut the power off.
- If you are unclear as to how to proceed, please consult a licensed electrician.

UNPACK THE FIXTURE: Check the contents of the box. Box should contain all items on the parts diagram.



For any replacement parts or installation issues, please Contact Us!

Email: help@kira-home.com

Facebook/Instagram: @KiraHomeDecor

Phone: 888.208.2085

INSTALLATION INSTRUCTIONS

1. Secure Mounting Plate (A) to the junction box (not included) using Mounting Screws (B) provided. Ensure Mounting Plate (A) is positioned with the brackets on the left and right.
2. Using the wire graph below, connect the appropriate wires from the fixture to the corresponding wires in the electrical junction box (not included) and secure Wire Connectors (C).

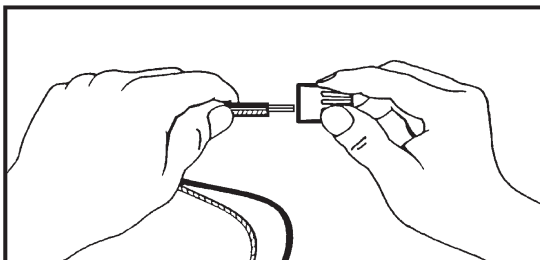

Connect to BLACK house wire	Connect to WHITE house wire
BLACK 	WHITE
PARALLEL WIRE (ROUND & SMOOTH) 	PARALLEL WIRE (RIBBED / RIDGED)
WHITE OR GREY WITH TRACER 	WHITE OR GREY WITHOUT TRACER
BROWN, GOLD OR BLACK WITHOUT TRACER 	BROWN, GOLD OR BLACK WITH TRACER

- A. Connect the ground wire (bare copper or green) from your fixture to the:
 - 1) ground wire in the junction box, or
 - 2) ground screw in the junction box
- B. Connect the BLACK house wire to fixture hot wire that corresponds to diagram (black, round & smooth, white/gray with tracer, brown/gold without tracer).
- C. Connect the WHITE house wire to fixture neutral wire that corresponds to diagram (white, ribbed/ridged, white/gray without tracer, brown/gold with tracer).

3. Place all wires and Wire Connectors (C) back into the junction box.
4. Place Backplate Assembly (D) against the wall, ensuring holes on each side of Backplate Assembly (D) align with the holes on Mounting Plate (A). Secure Backplate Assembly (D) to Mounting Plate (A) with Backplate Screws (E).

5. Install light bulb (not included) into Socket (F).

CAULKING INSTRUCTIONS

1. After securing the backplate against the wall, seal entirely around the gap between the wall and backplate with good quality waterproof caulk or silicone sealant (not included) and allow it to dry.

Enjoy your new fixture!

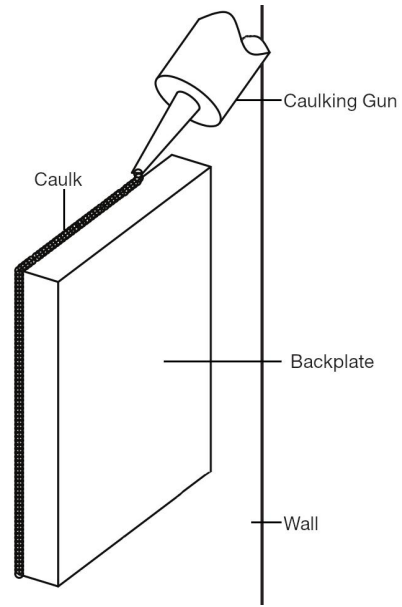

Kira Home

ITEM #: RVL-OW7648-1 - PARTS DIAGRAM

HELPFUL TOOLS: Safety Goggles, Screwdriver, Ladder, Measuring Tape

