

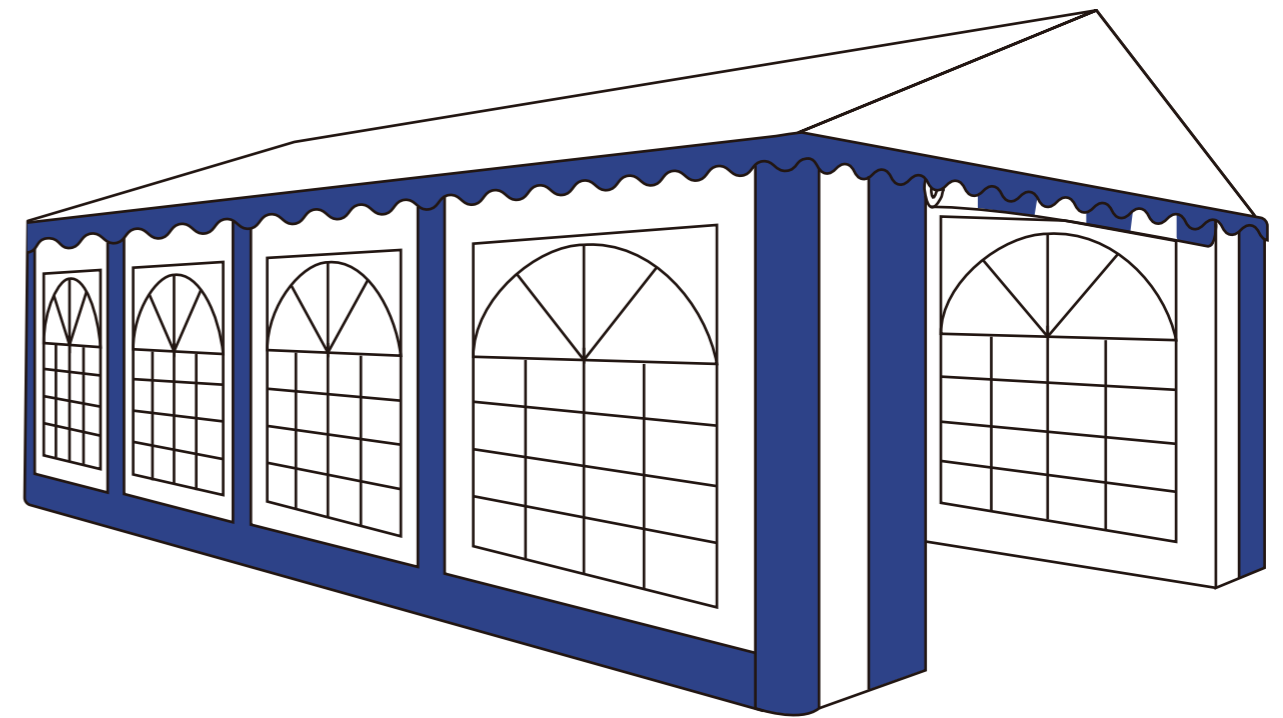

USE AND CARE GUIDE

GA104-BW



Questions, problems, missing parts? Before returning to the store please contact our Customer Service

- service@alphamarts.com •

1-877-606-2818

Questions, problems, missing parts? Before returning to the store please contact our Customer Service

- service@alphamarts.com •

THANK YOU

We appreciate the trust and confidence you have placed in us through the purchase of our product. We strive to continually create quality products designed to enhance your home. Visit us online to see our full line of products available for your home improvement needs. Thank you for choosing us!

Table of Contents

Table of Contents	2	Pre-assembly	3-4
Safety Information	2	Assembly	5-7
Warranty	2	Warning	8
What is Covered	2		
What is Not Covered	2		

Safety Information

- **Do not completely tighten screws until all screws are started.** Tighten each bolt firmly and properly.
- Some parts may contain sharp edges. Wear protective gloves as necessary.
- Children under the age of 16 should not be engaged in the assembly, removal or disassembly of the product. Children under the age of 10 should be supervised by a competent adult while using this furniture.
- Please keep children out of the assembly area during assembly.
- This set is heavy, and may require two adults for safe assembly.
- Never use this product as a support. Do not shake, lean, or climb on the product at any time.



DANGER : Do not allow children to play with plastic wraps or small parts to prevent potential choking hazard.



CAUTION: Read all the instructions before assembly. Failure to do so may result in faulty assembly and potential injury!

Warranty

LIMITED WARRANTY

This warranty is a limited warranty, and applies to the original purchase is required. This is a residential warranty and does not apply to commercial use. This collection carries a (1) year limited warranty and is valid from original date of purchase to the original owner (proof of purchase required).

WHAT IS COVERED

We warrant the frame to be free of Manufacturing defects to the original purchaser for one year.

WHAT IS NOT COVERED

This warranty does not cover commercial use, hardware, acts of nature, fire, freezing and abusive. In addition, purchased parts are not covered under this warranty.

We reserve the right to make substitutions with similar merchandise, if the model in question is no longer in production.

For a copy of our full limited warranty, please contact our customer service team.

Pre-assembly (continued)

Assemble the item on a soft, non-abrasive surface, such as carpet or cardboard to avoid damaging the item. Seek assistance to assemble bulky or heavy items.



NOTE: Identify all parts packed in the carton against the parts list. Remove all the protective material carefully and DO NOT use a knife to prevent scratching the furniture.

PACKAGE CONTENTS



NOTE: Hardware not shown to actual size.

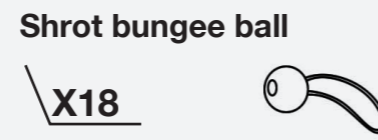
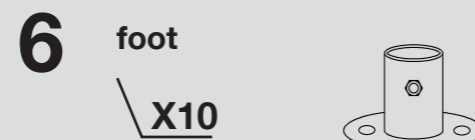
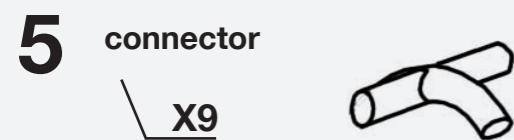
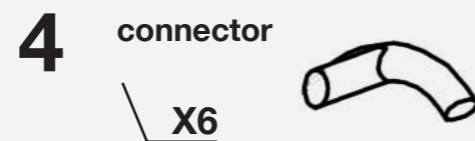
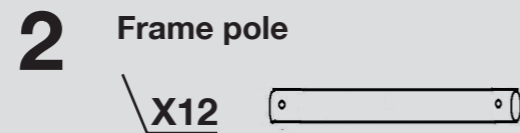

Pre-assembly (continued)

Guy line



6x300mm Peg
SPIRAL

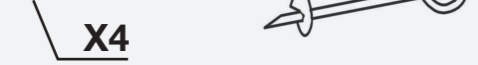

6x180mm peg
MIDDLE

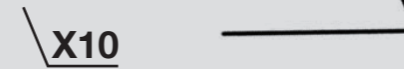

4x180mm peg
SHROT

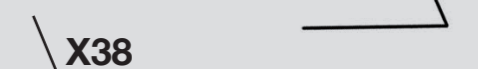

Hook

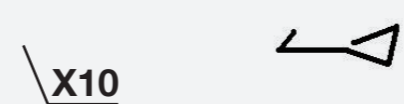

Roof



Sidewall



End wall

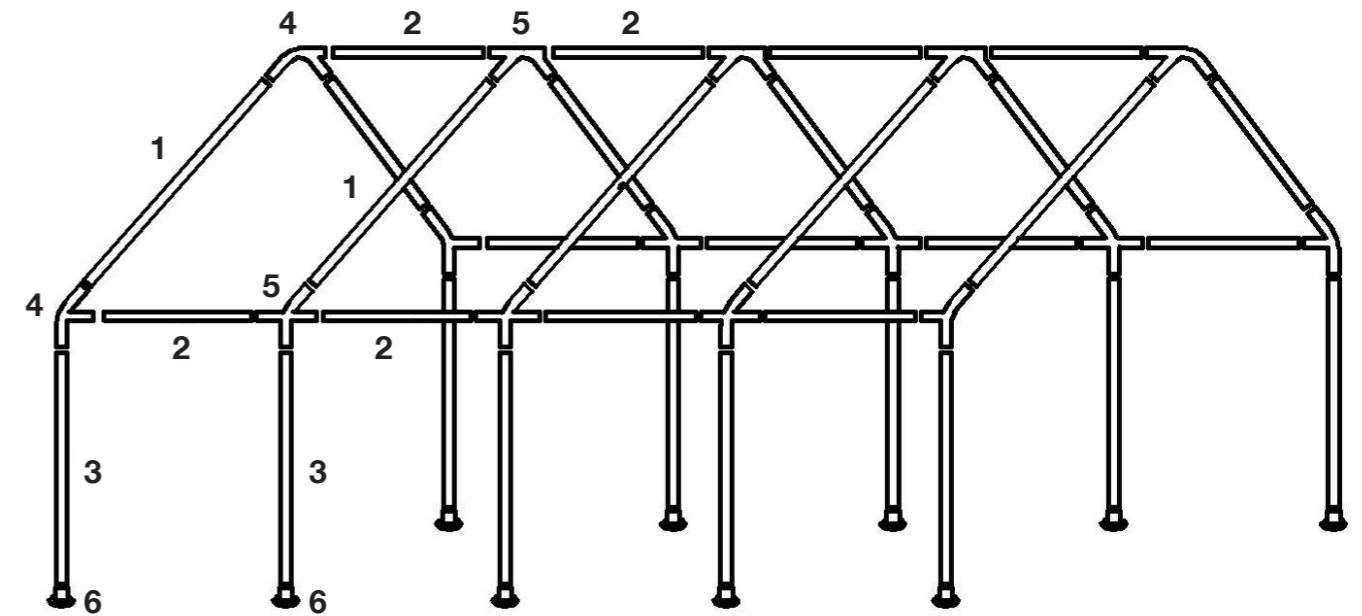
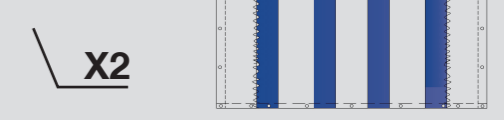

Assembly

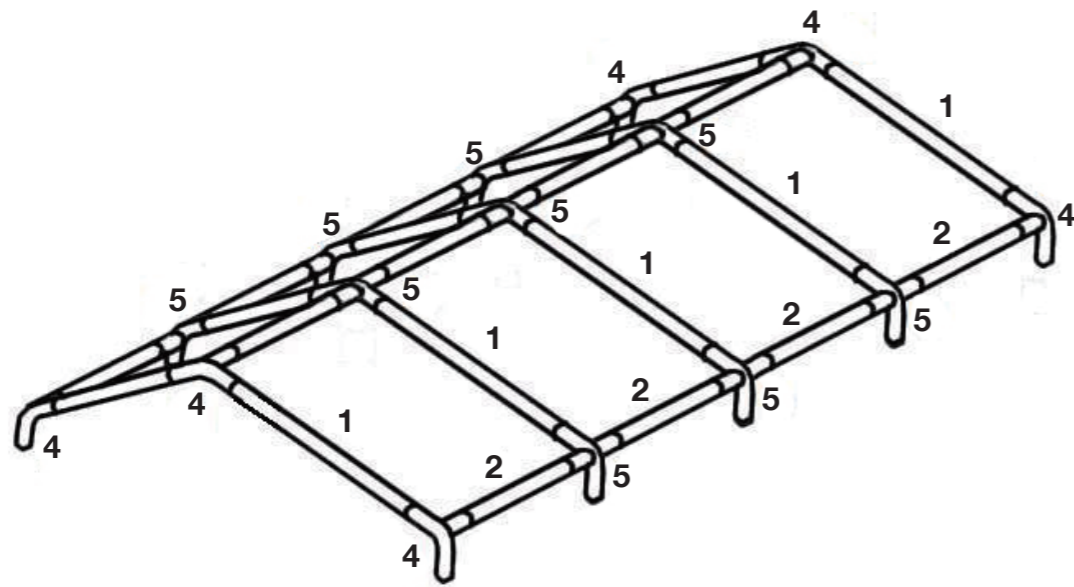

1

Select a flat ground for the tent, unpack the carton and check all the parts including tubes, tent and accessories... etc. are present as same as list.
Assemble the framework of rooftop by joining the portion (4,5) together with poles (1,2).
To ensure the screw fixed to every pole tightly .

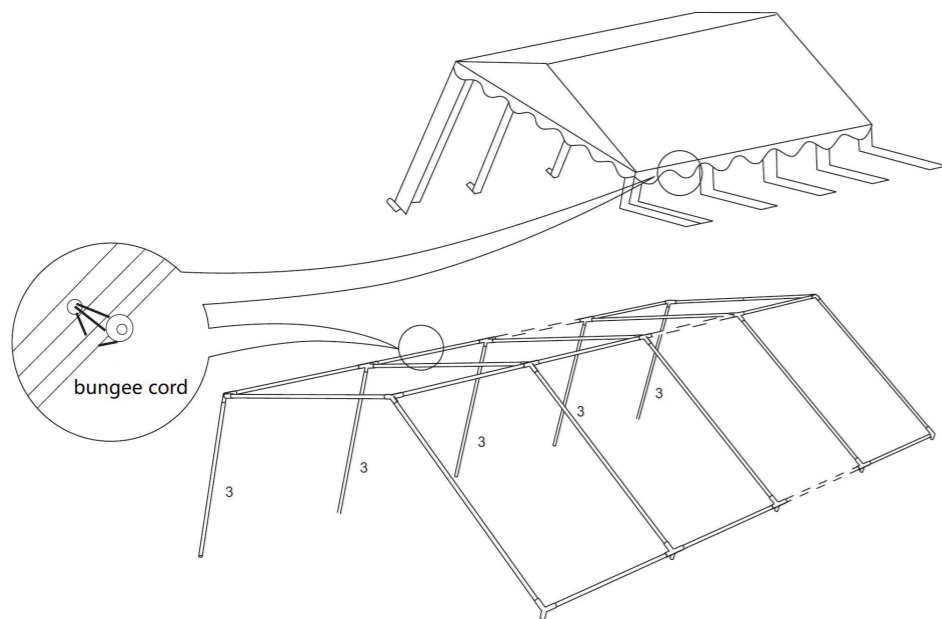

2

Attach one end of supported pole (3) to the joints (4,5) , at same time, fit the foot 6 to leg 3. Cover the roof on the frame ,and attach it by the bungee balls properly ,take care of the tension of the bungee balls ,for if you use too many on one side of tent ,it may too tight to tie the other side of it .

Assembly

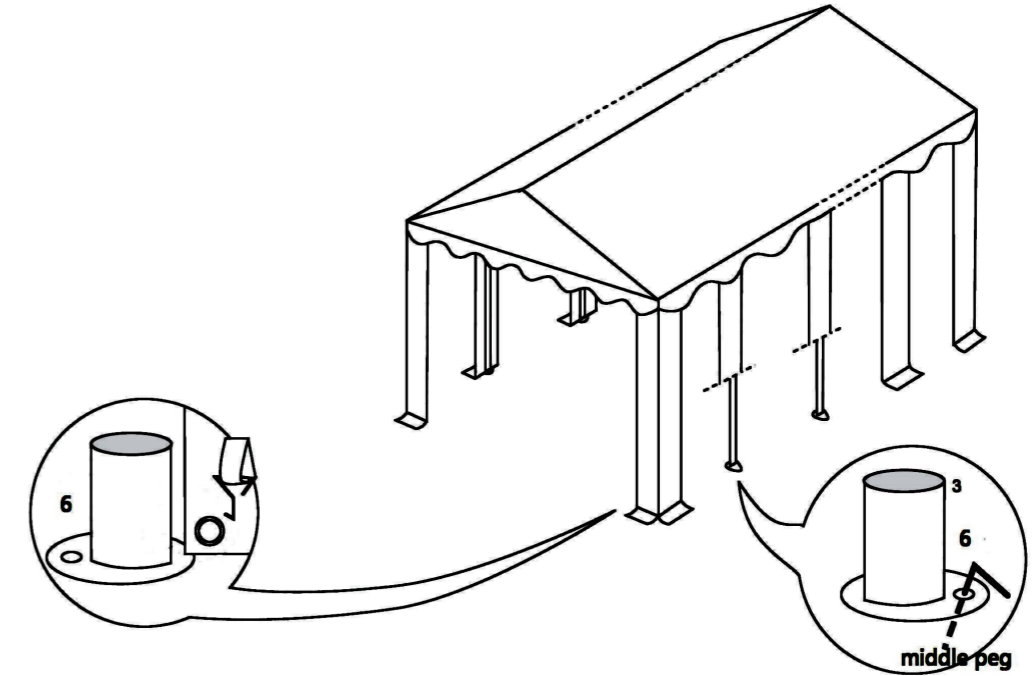

3

Attach the another 4 supported poles (3) to the joints (4,5), built-up the framework ,use the 6x180mm peg to fix each pole into the ground and use the hook to fix the leg cover to the leg .

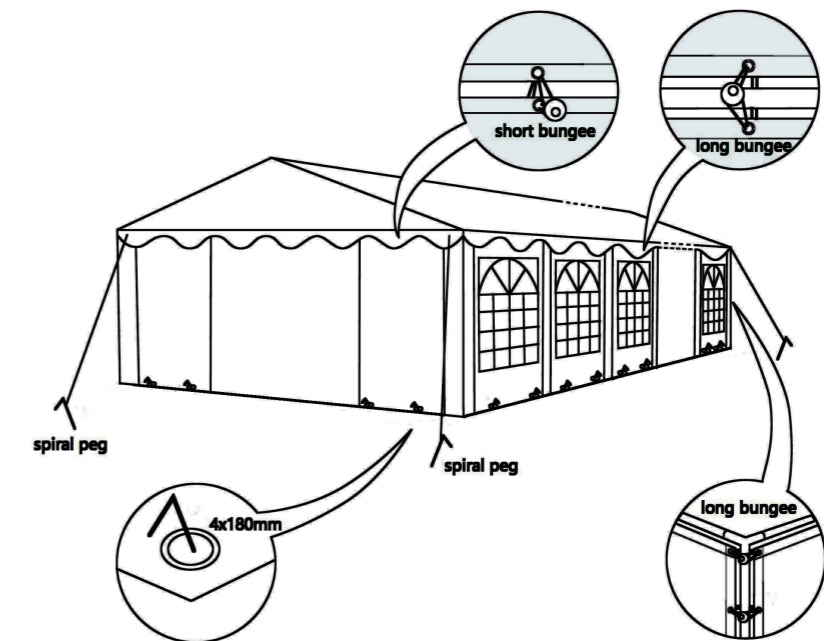

4

Spread the wall panel and door panel attach to framework by using the bangee cords clasping the frame to grommets that is construct over the wall panel and door panel to ensure stability. Also use the short pegs to fix the doors to the ground. The Guy lines clasp to each corner of tent and another end of line fix to ground by SPIRAL PEGS.

Warning

- Take note that the tent needs to be handled carefully to avoid damage.
- Do not force the frame, as there may be damage in the process.
- Tents are meant as temporary shelter and must be evacuated under extreme weather conditions.
- Please select a suitable site for the tent to avoid damage to underground sprinkler systems, water, gas or electrical lines.
- Keep away from naked flame and other heat sources.
- Take preventative measures to avoid wind when wind speed reaches 25 mph or higher.