

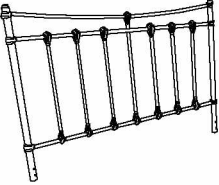









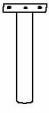

# ASSEMBLY INSTRUCTION

## METAL QUEEN BED

<b>A</b> Headboard  1PC	<b>B</b> Footboard  1PC	<b>C</b> Side rail  2PCS	<b>D</b> Slats  3PCS
<b>E</b> Extension leg  2PCS	<b>F</b> Support leg  3PCS	<b>G</b> Bolt with ball  4PCS	<b>H</b> Adjustable bolt M6*25mm  3PCS
<b>I</b> Bolt M8*50mm  12PCS	<b>J</b> Bolt M6*15mm  18PCS	<b>K</b> Nut M8  8PCS	<b>L</b> Flat washer  12PCS
<b>M</b> Allen wrench 4*4mm  1PC	<b>N</b> Wrench  1PC		

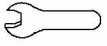
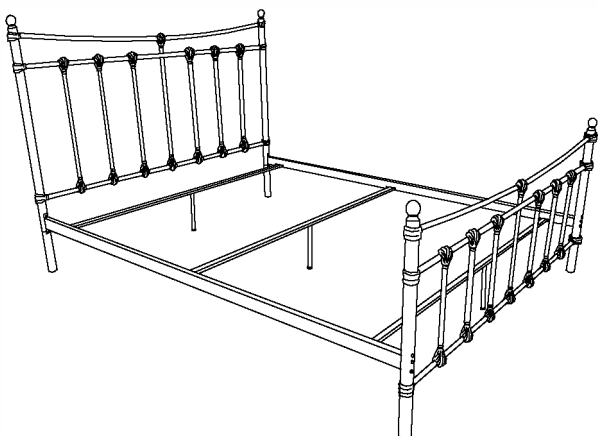

This page lists all the contents included in the box. please take the time to identify the hardware as well as the individual components to this product. As you unpack and prepare for assembly, place the contents on a carpeted or padded area to protect them from damage.

**1** Insert the Extension leg (E) into the Headboard (A).

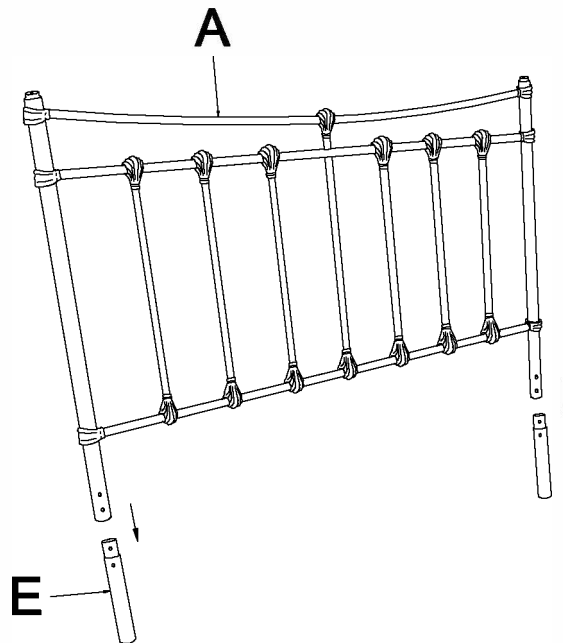

**2** Assemble 4 pcs Bolt with ball (G) to the Headboard (A) and Footboard (B). Assemble the Side rail (C) to the Headboard (A) and Footboard (B) with 12 pcs Bolt (I), 8 pcs Nut (K) and 8 pcs Flat washer (L) by Allen wrench (M) and Wrench (N).

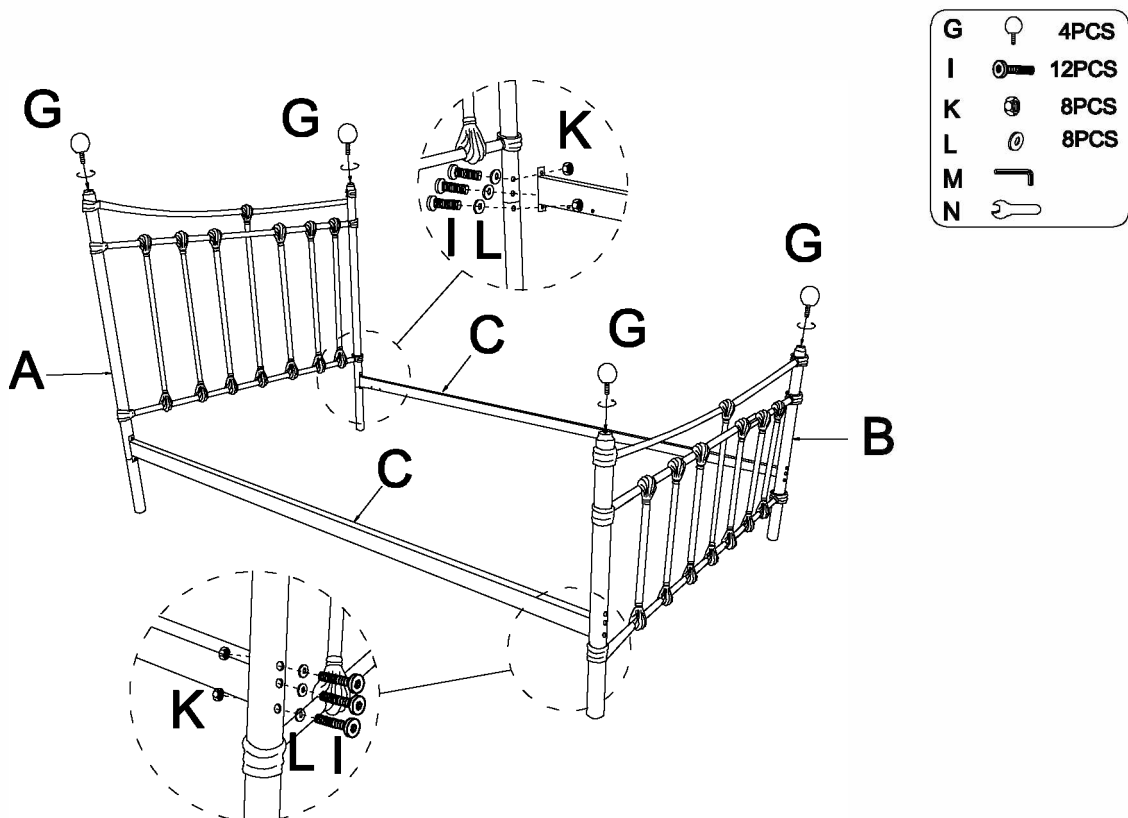

**3** Assemble 3 pcs Support leg (F) to the Slats (D) with 6 pcs Bolt (J) and 3 pcs Adjustable bolt (H) by Allen wrench (M).

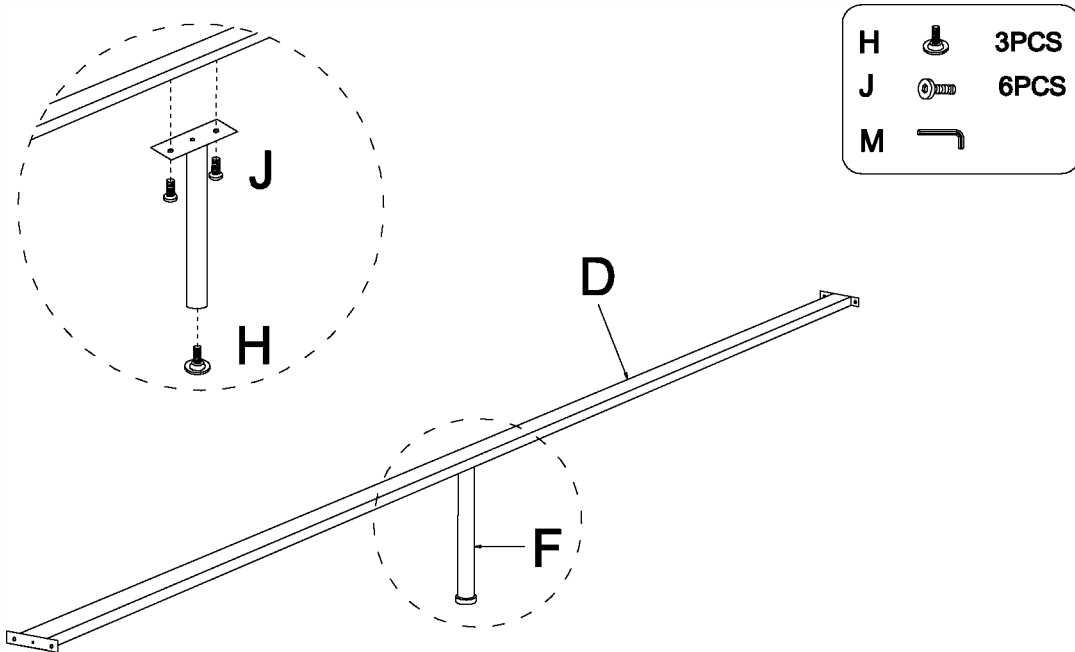

**4** Assemble the Slats (D) with 12 pcs Bolt (J) to the Side rail (C) by Allen wrench (M).

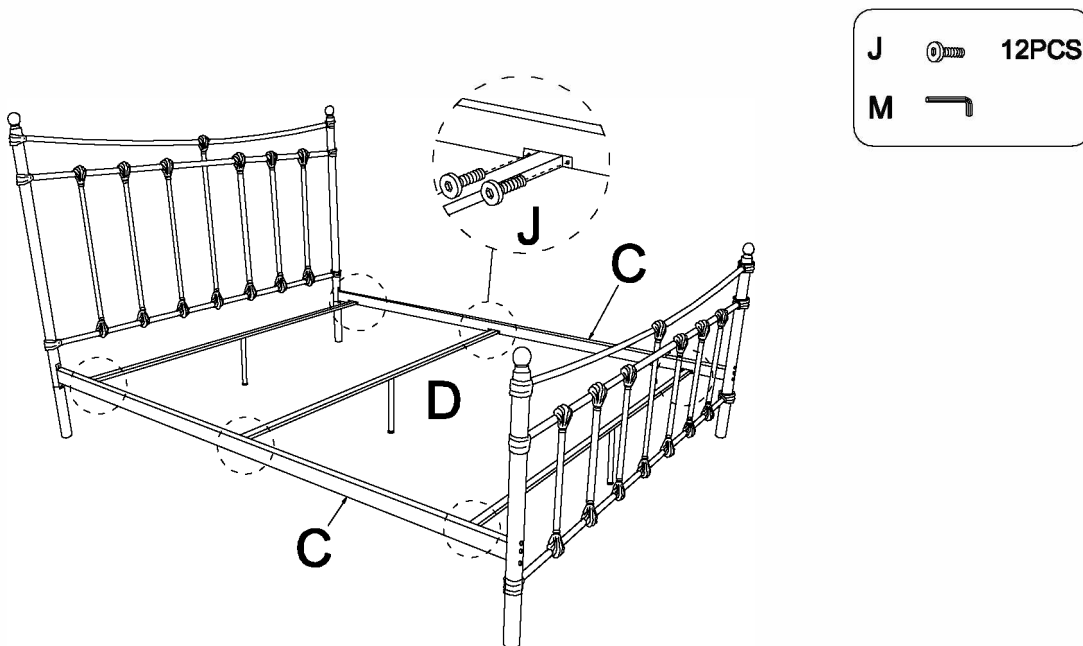

#### Cleaning & Care

Treat surface with care. Surface is resistant to scratches but is not scratch resistant. Clean surfaces with a dry or damp soft cloth. Do not use abrasive cleaners. Hardware may loosen over time. Periodically check that all connections are tight.