



Instruction Manual

Thanks a lot your support and purchasing.

Please feel free to contact us if you have any questions with assembly or need replacement parts.

Assembly Instruction

Decorate your home, Brighten wonderful life

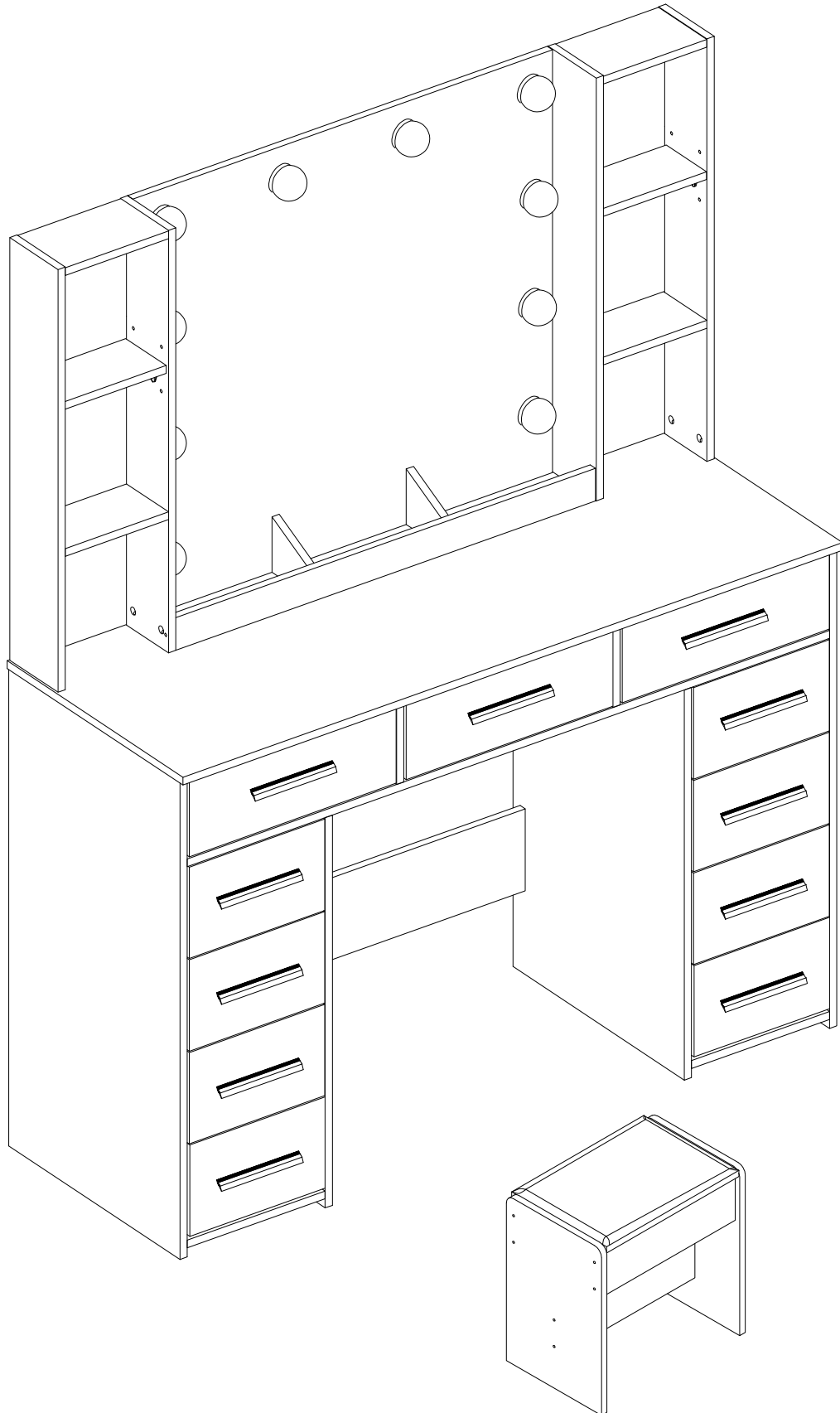

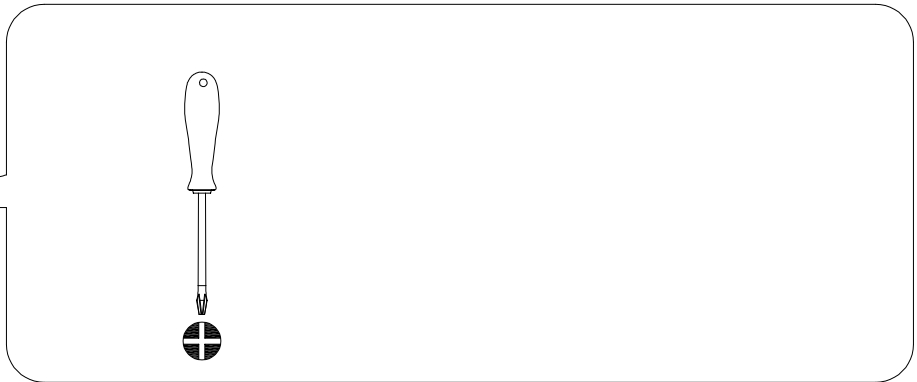
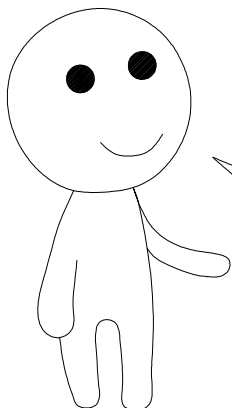
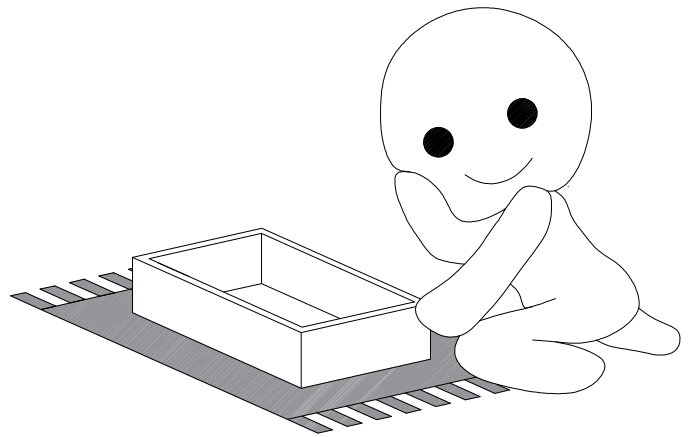
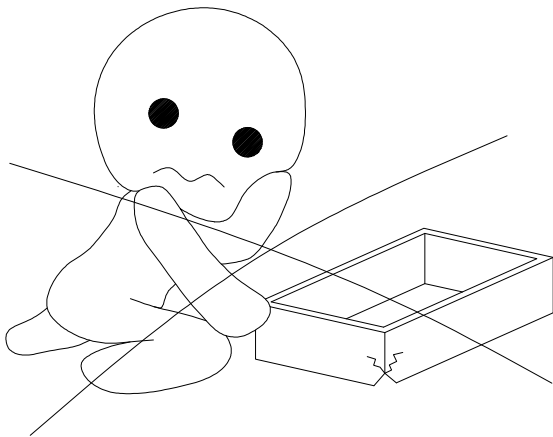
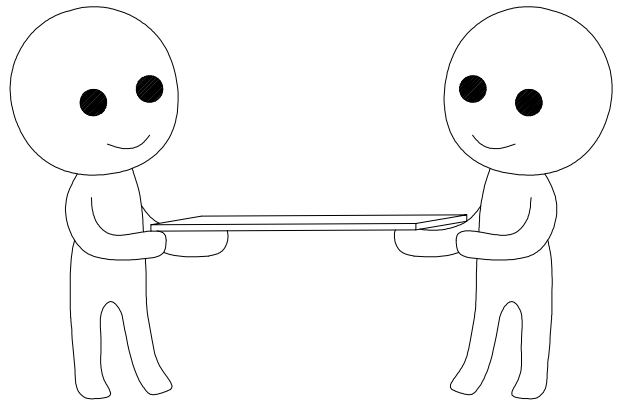
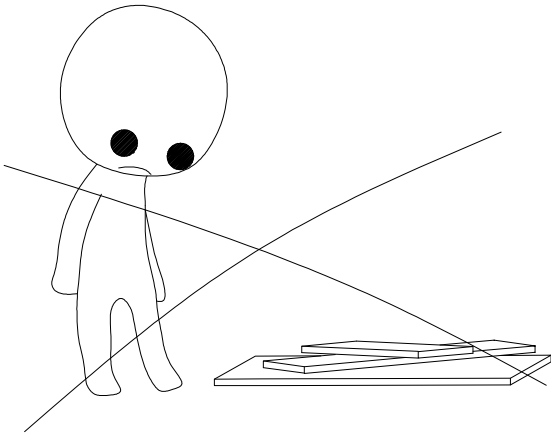
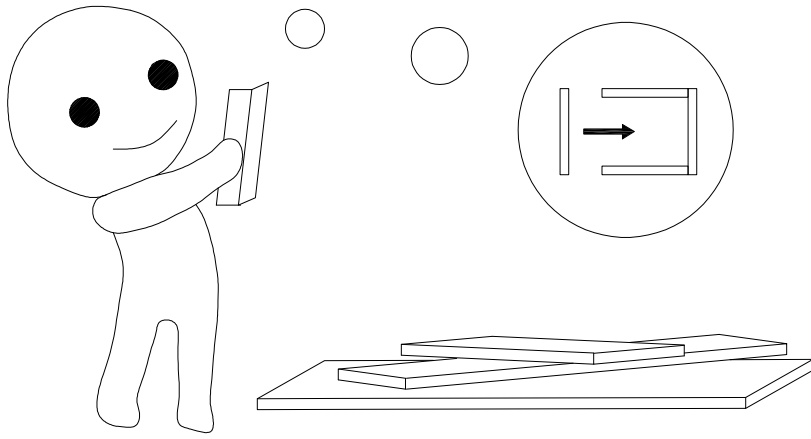
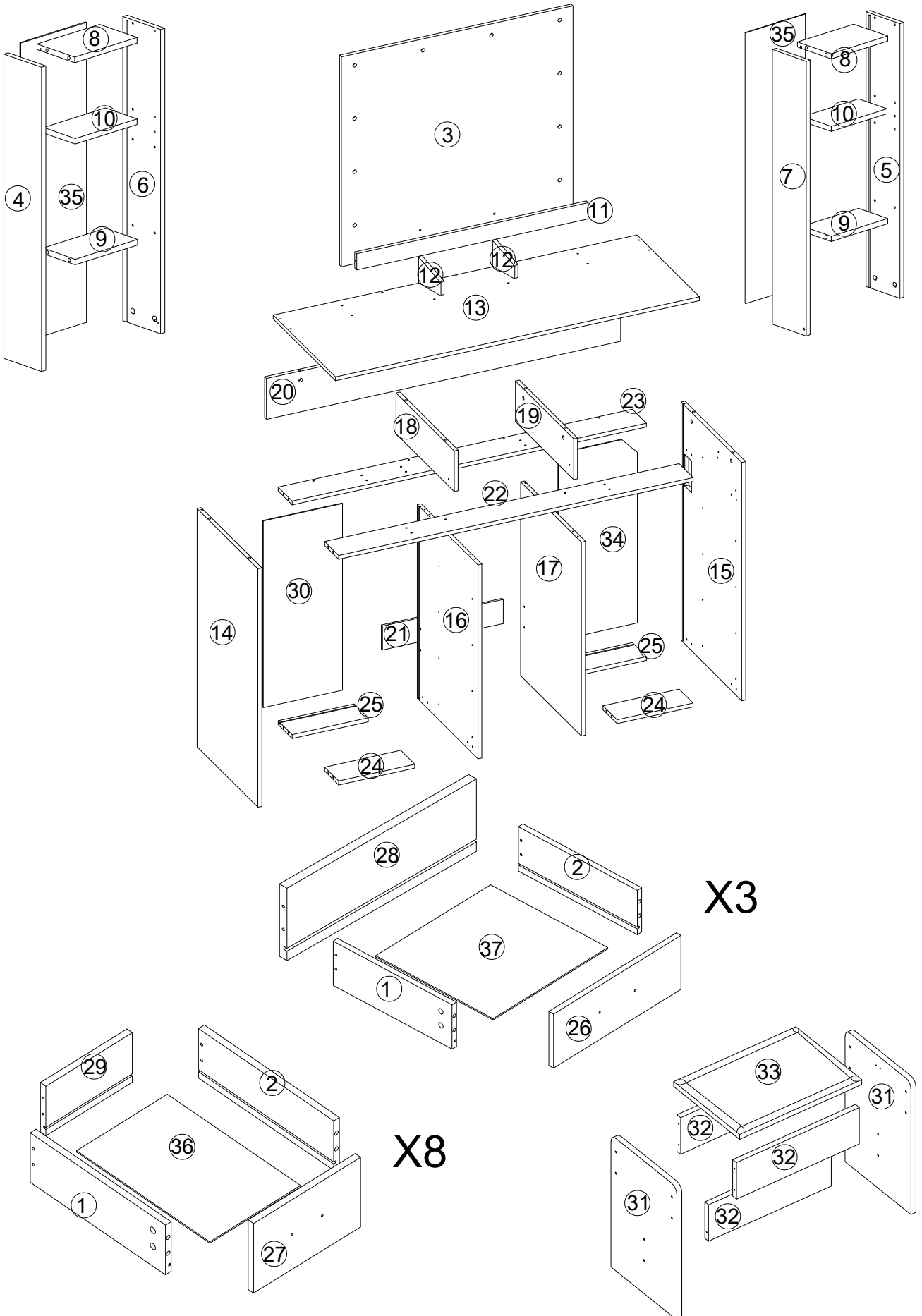
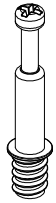

PLATE NUMBER



ACCESSORIES LIST

A ×107



M6×35

B ×107



12×10

C ×86

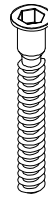

M5×40

D ×104

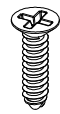

M3×12

E ×11

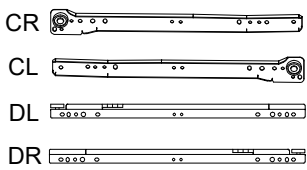

300MM

J ×4

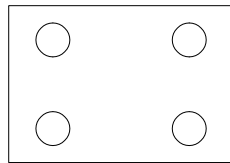

GDP13X20

K ×8

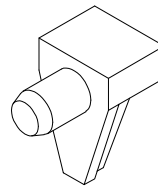

M ×22

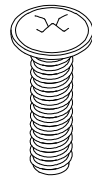

M4x14

N ×11

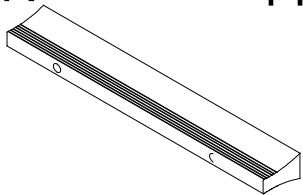

96MM

P ×1

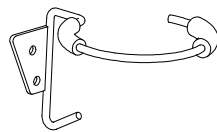

Q ×1

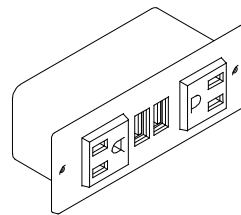

R ×16



M3.5x14

S ×10

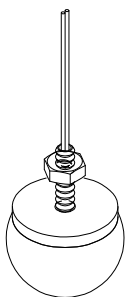

T ×2

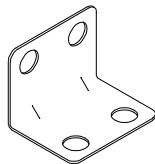

V ×1

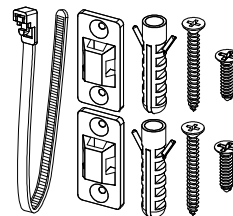

×1

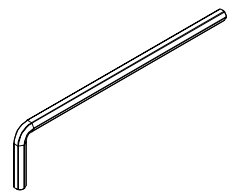

W ×2

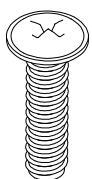

M4x20

X ×2

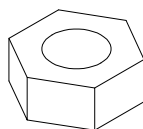

M4

Y ×8

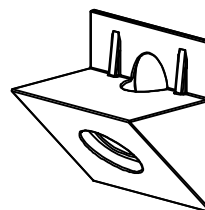

Z ×2

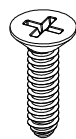

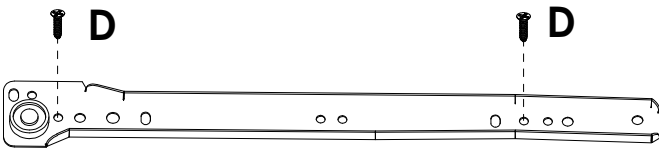
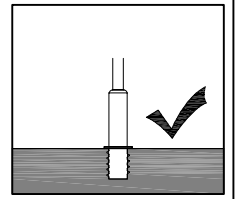
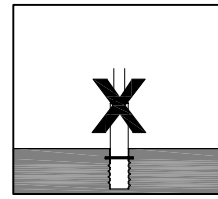
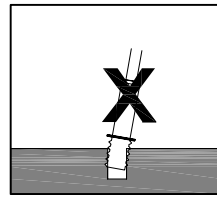
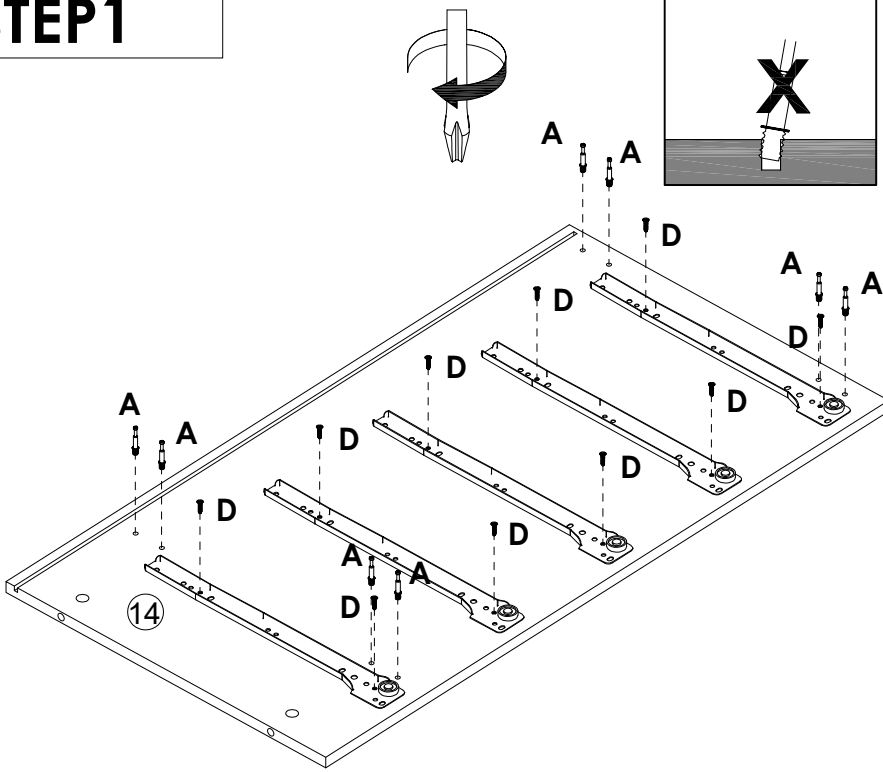

M3.5x12

STEP 1





E-CLx5

	
A X8	D X10

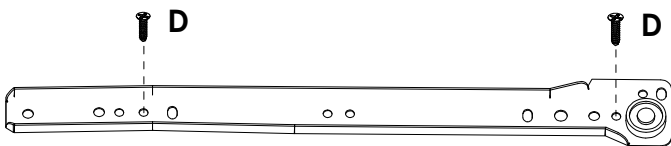
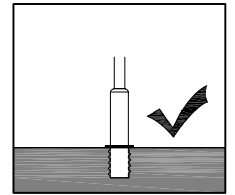
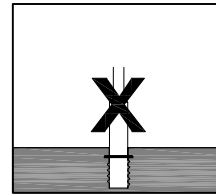
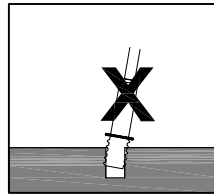
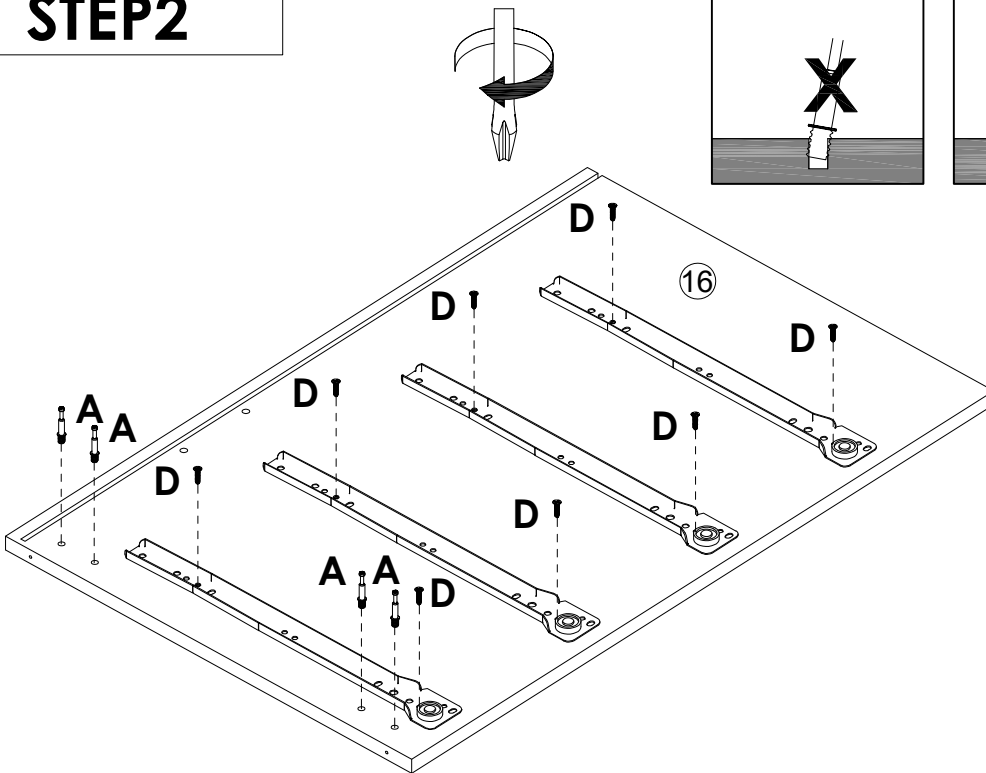
STEP 2



E-CRx4

	
A X4	D X8

STEP 3

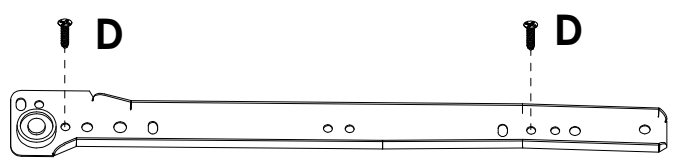
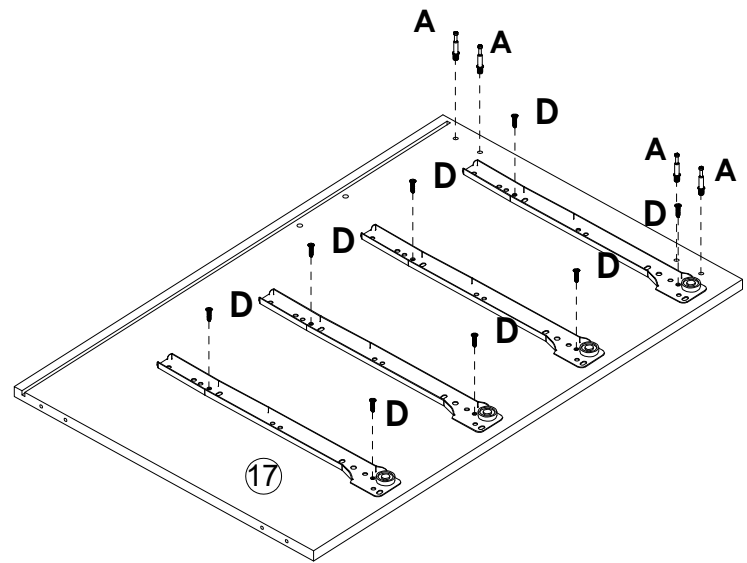
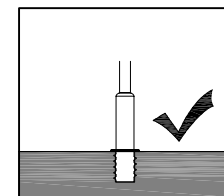
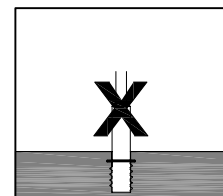
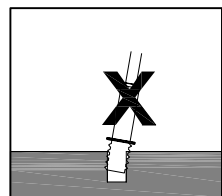
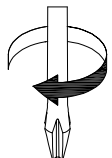

E-CLx4

A X4	D X8

STEP 4

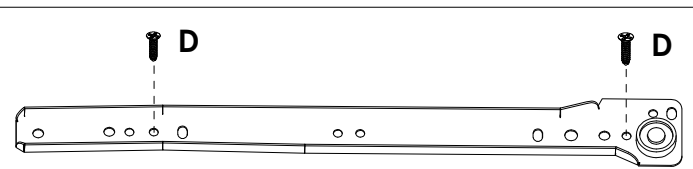
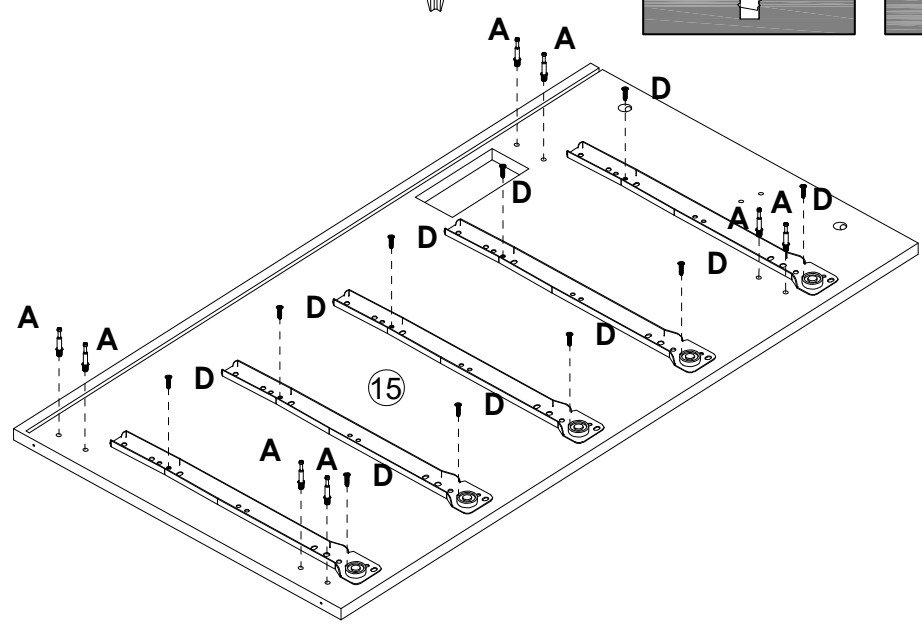
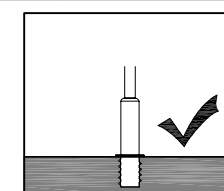
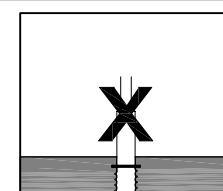
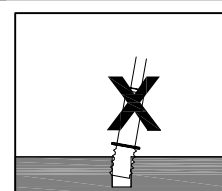
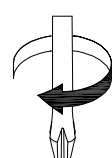

E-CRx5

A X8	D X10

STEP 5

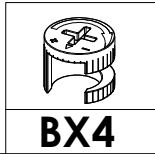
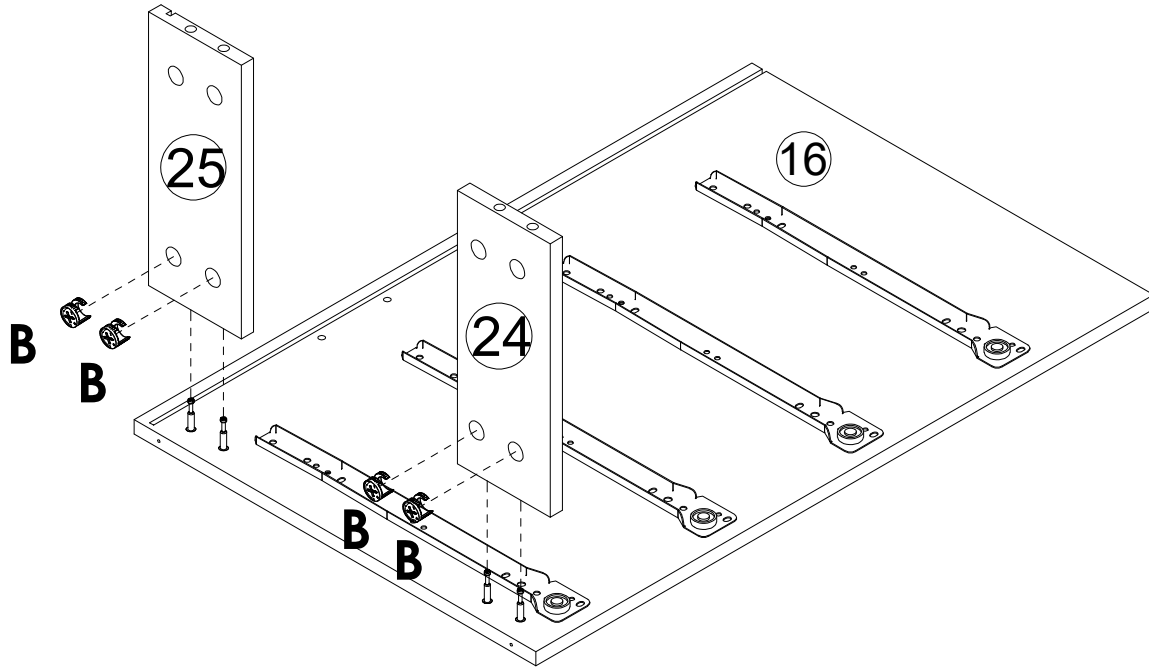
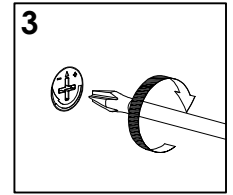
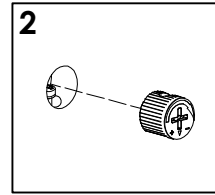
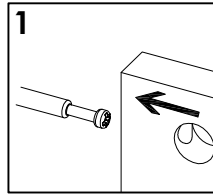
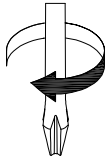

BX4

STEP 6

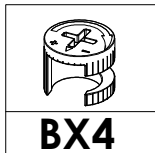
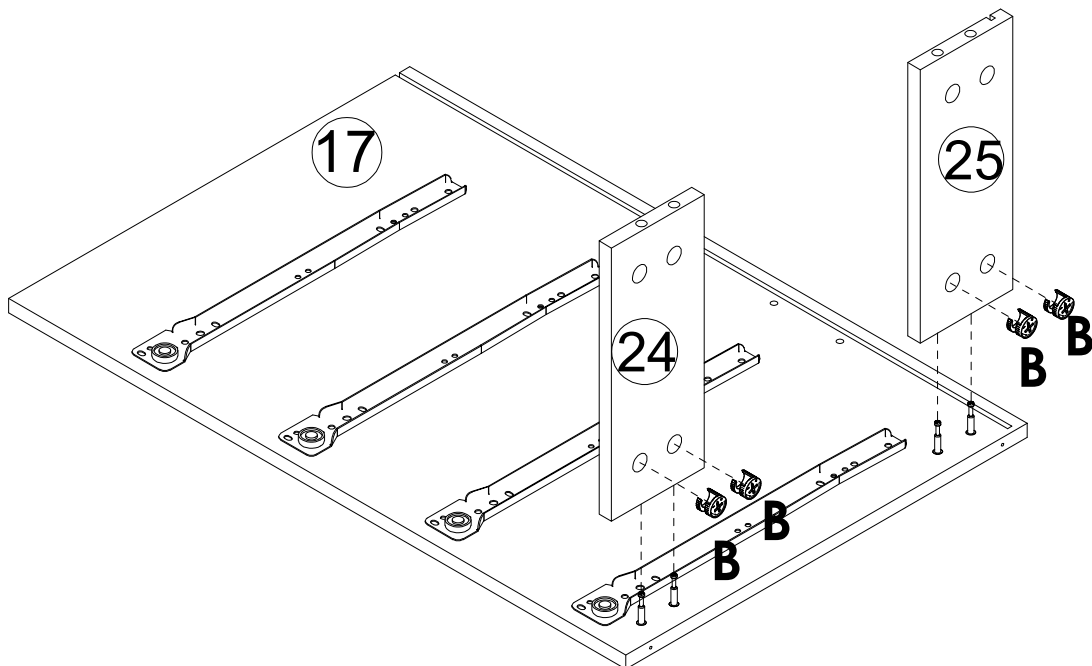
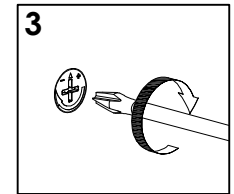
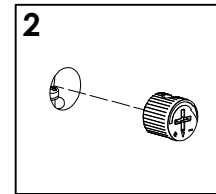
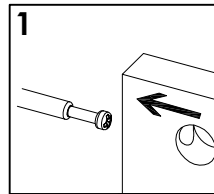
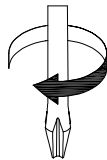

BX4

STEP 7

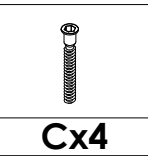
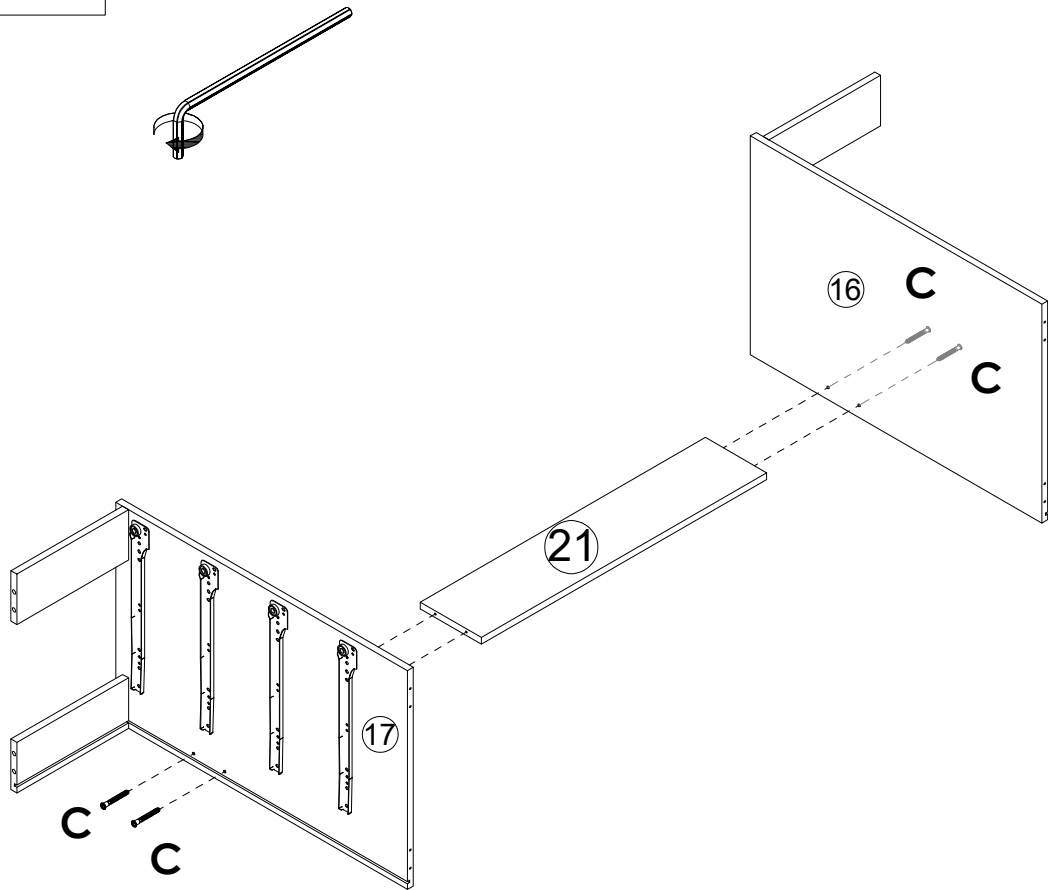

STEP 8

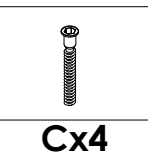
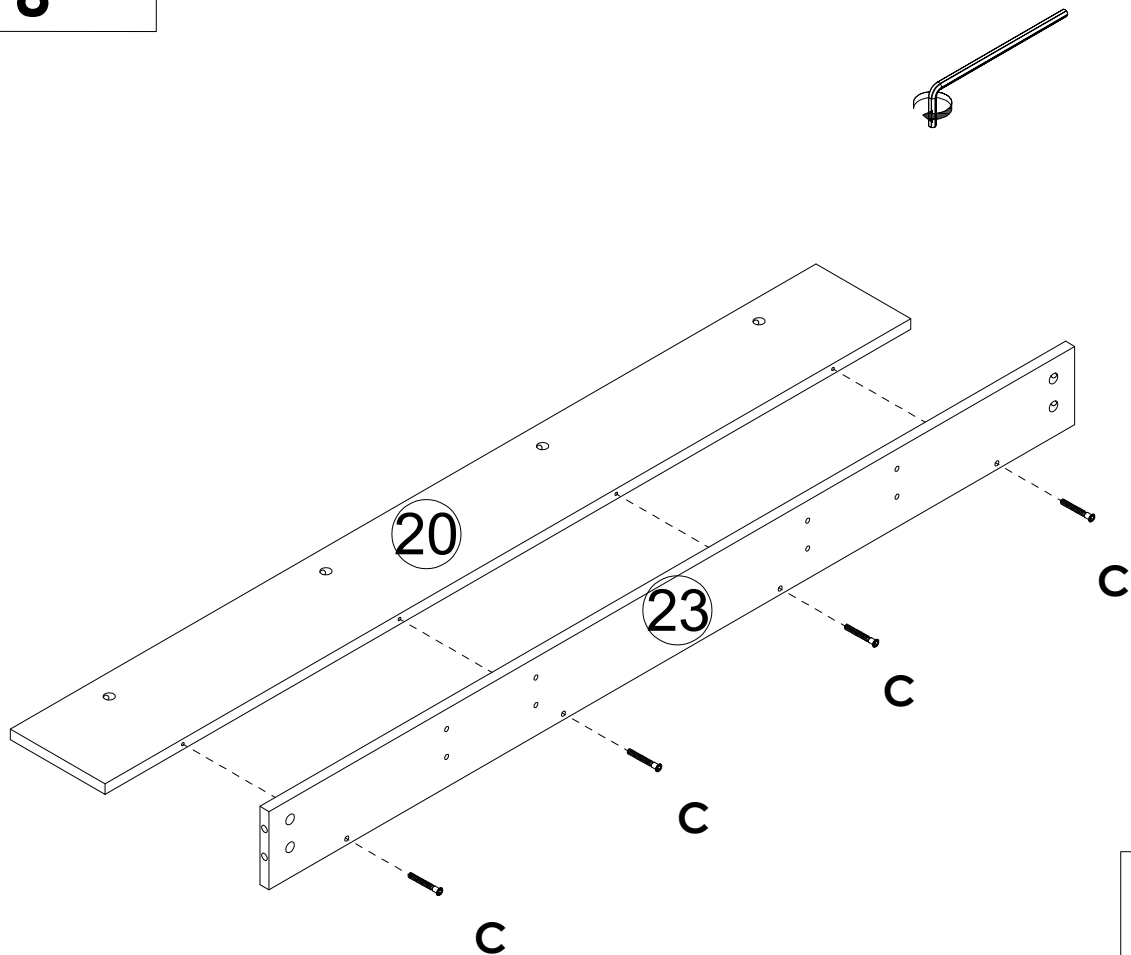

STEP 9

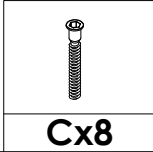
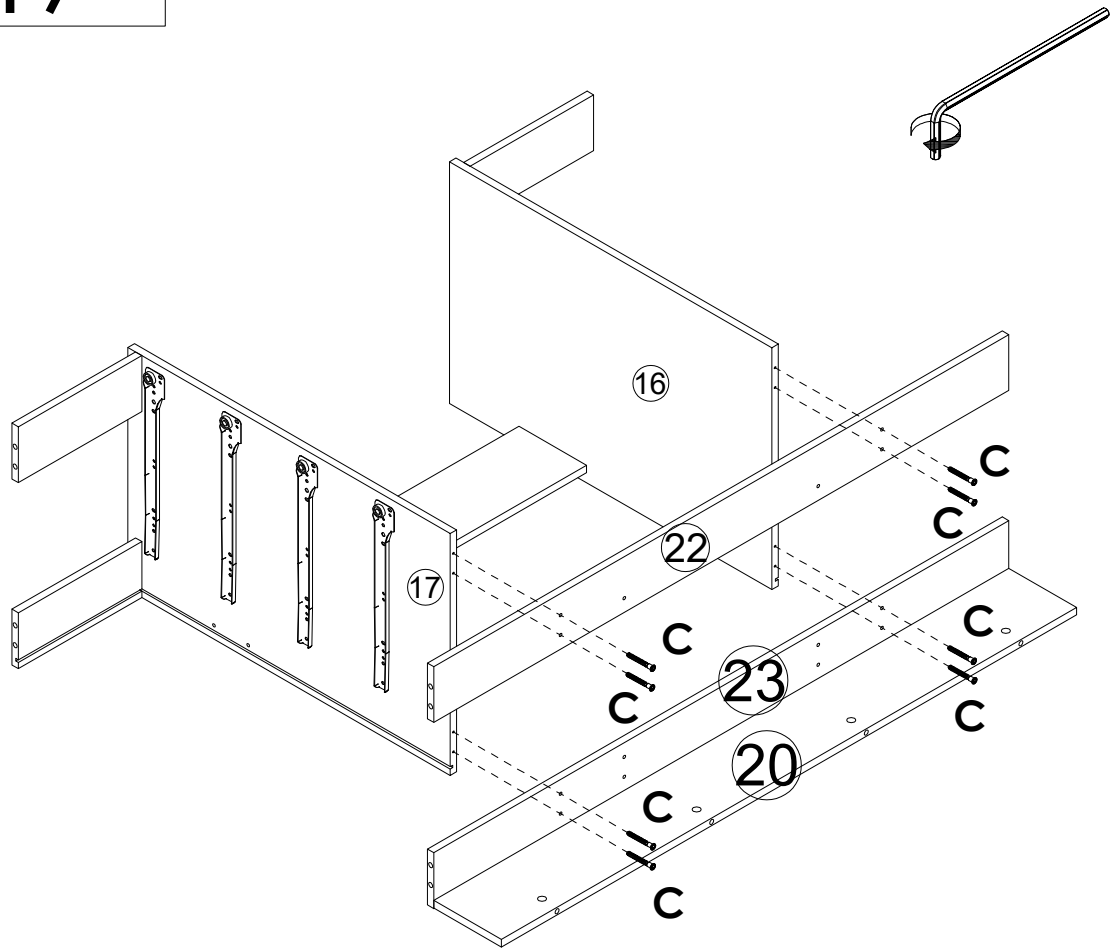

Cx8

STEP 10

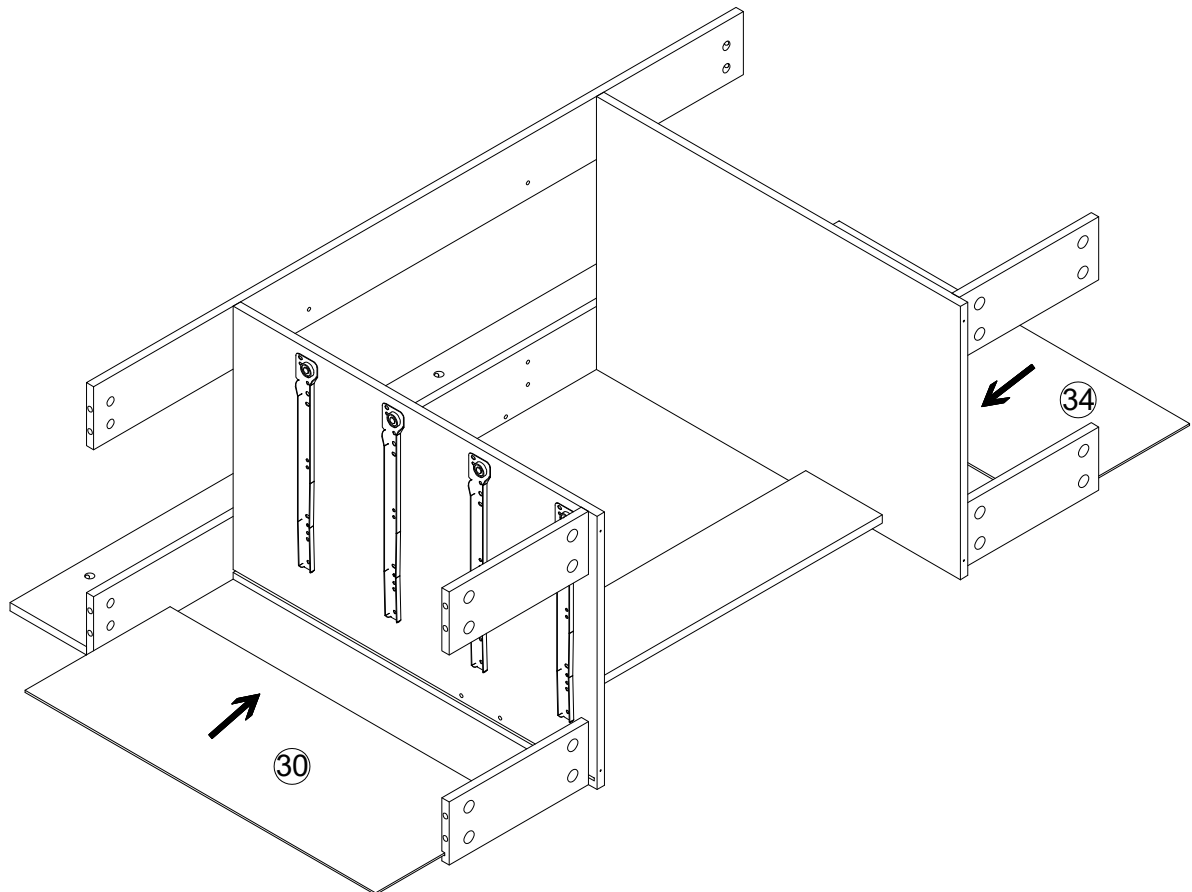

STEP 11

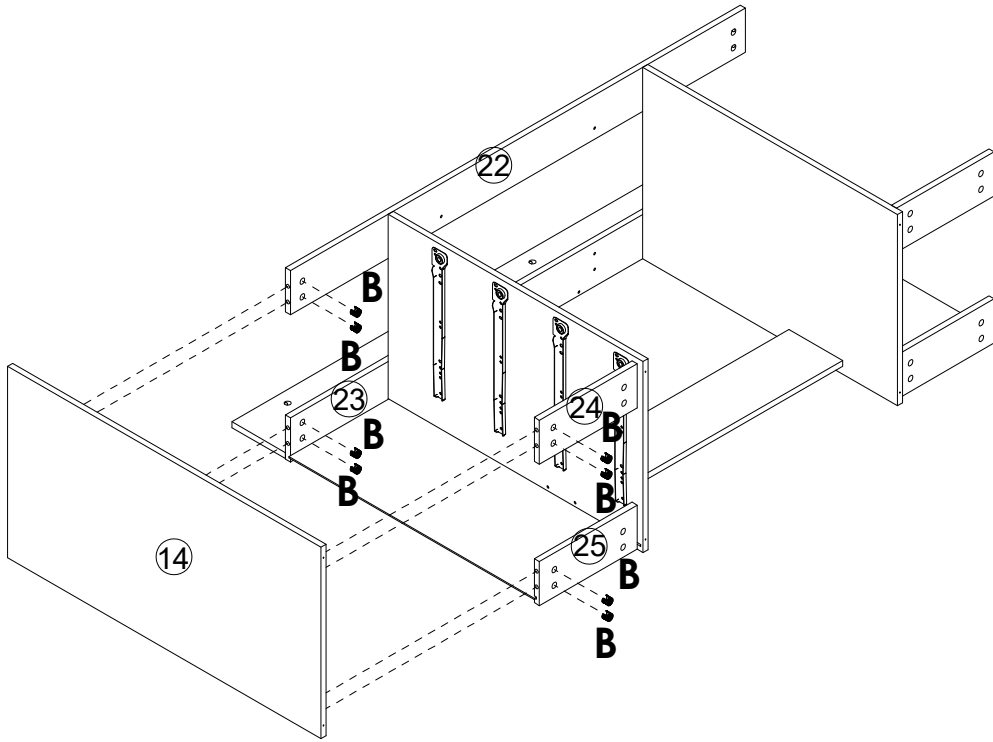
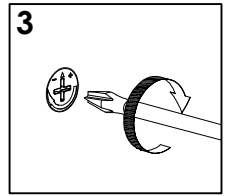
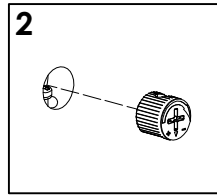
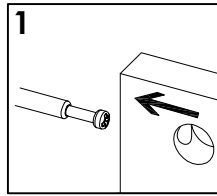
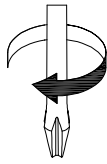

BX8

STEP 12

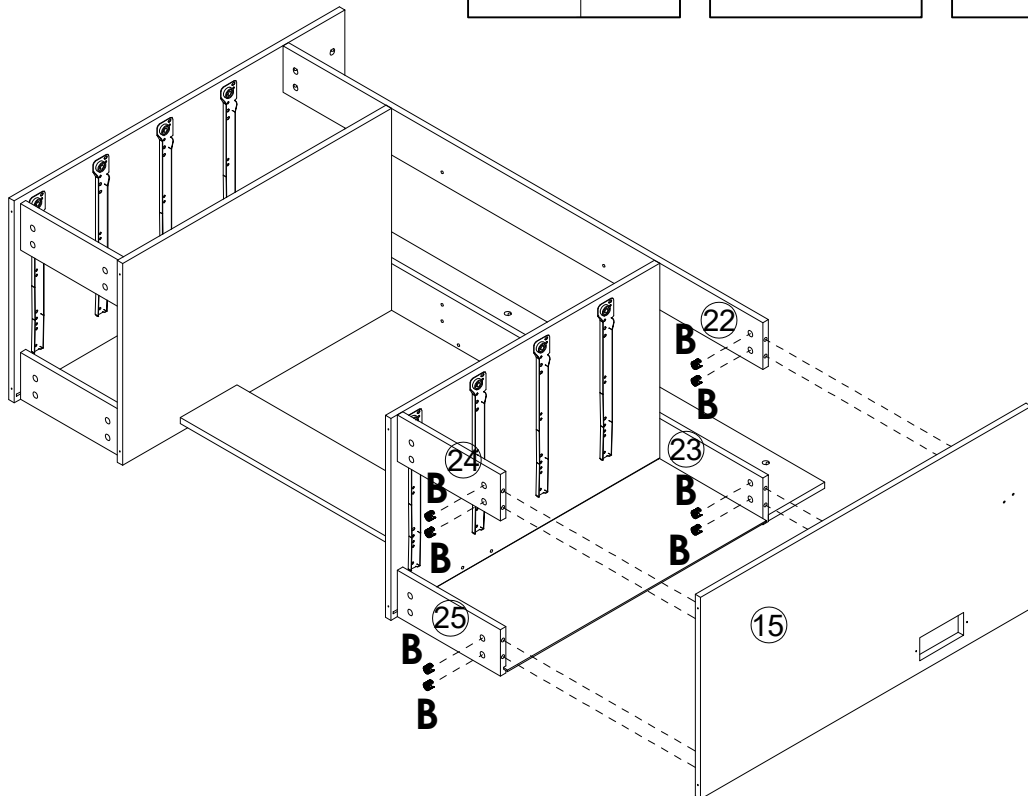
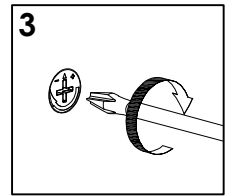
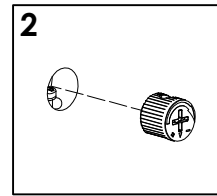
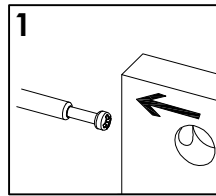
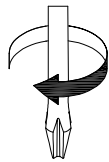

BX8

STEP 13

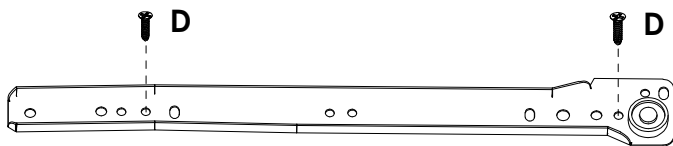
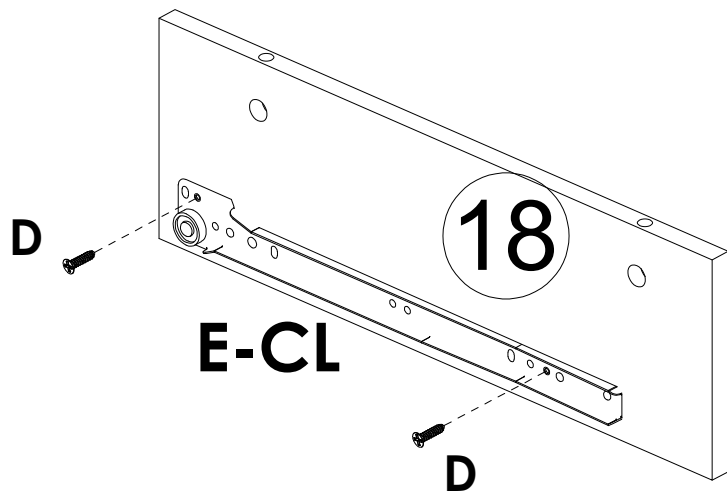
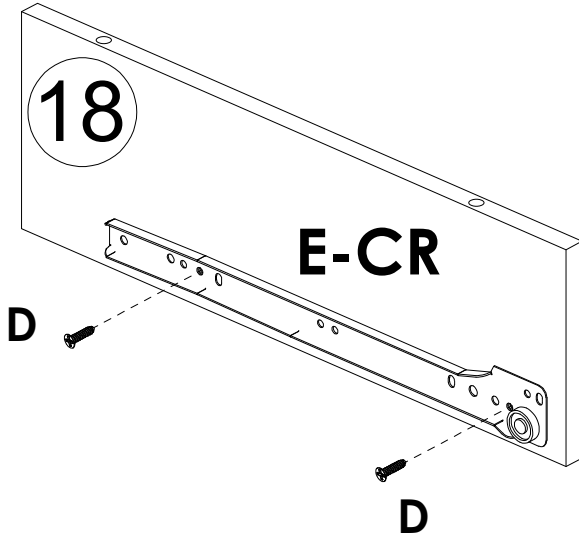
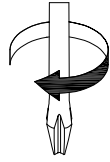

E-CRx1

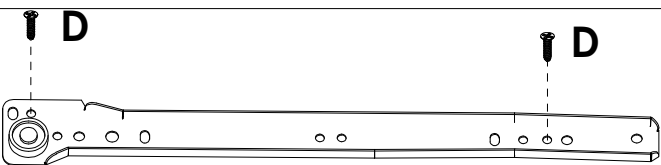

E-CLx1



Dx4

STEP 14

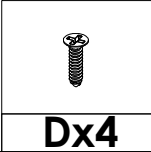
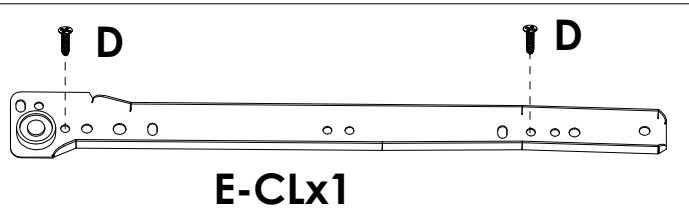
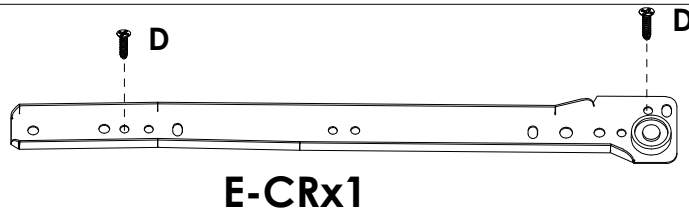
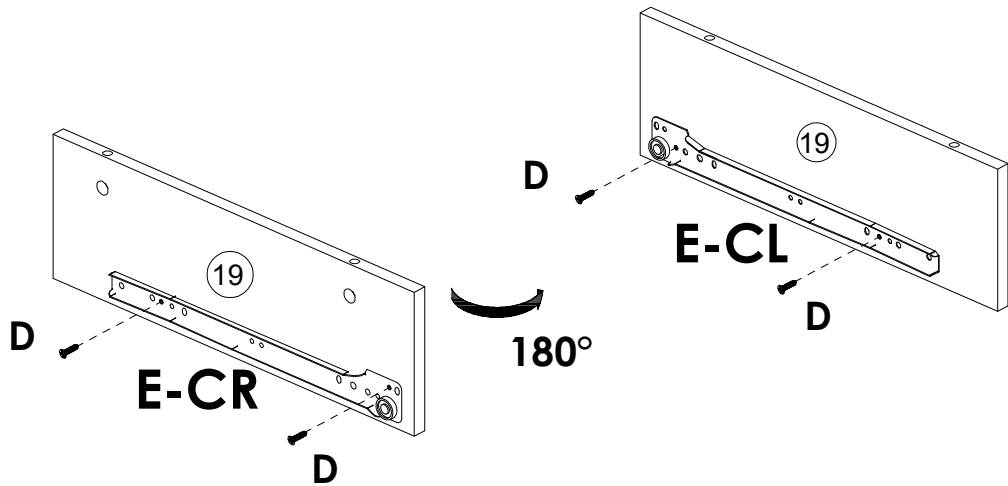
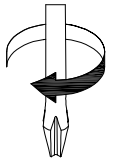



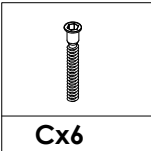
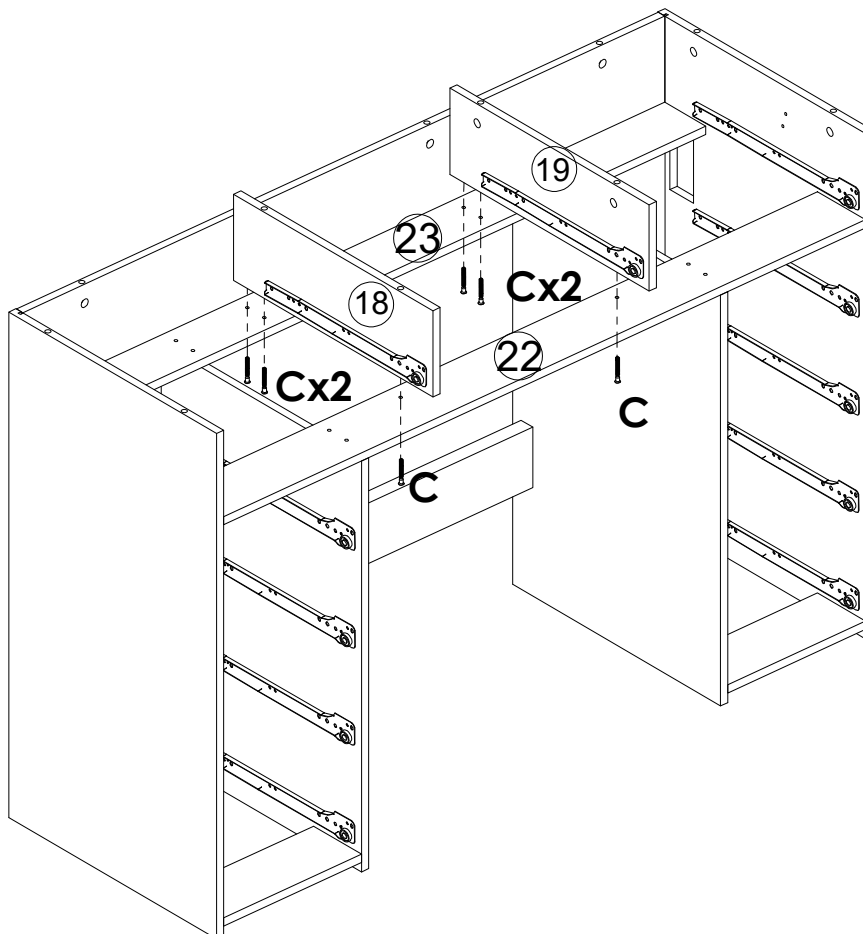
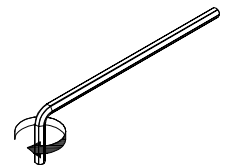

STEP 15

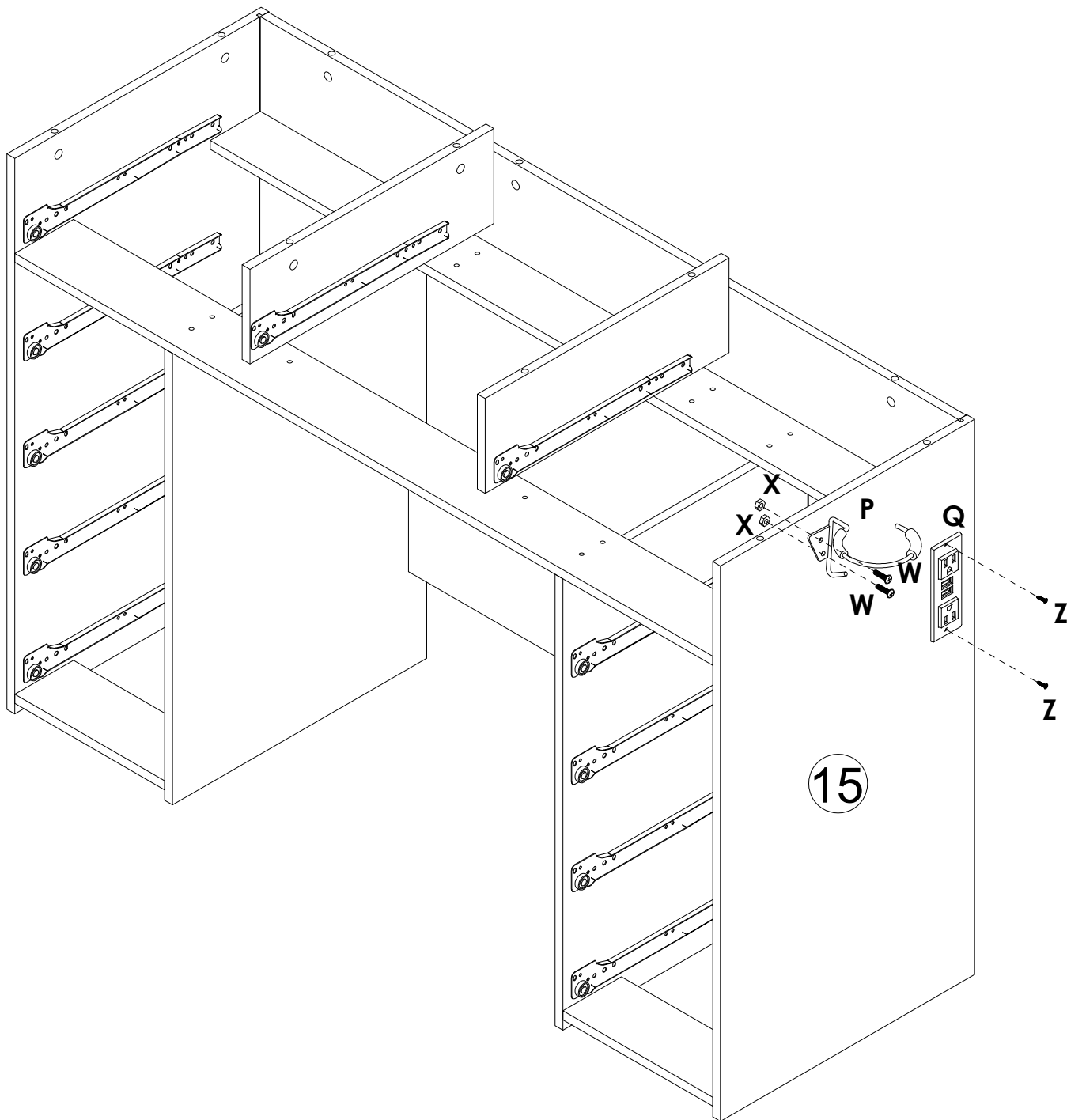
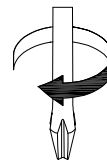

STEP 16



				
Zx2	Px1	Qx1	Wx2	Xx2

STEP 17

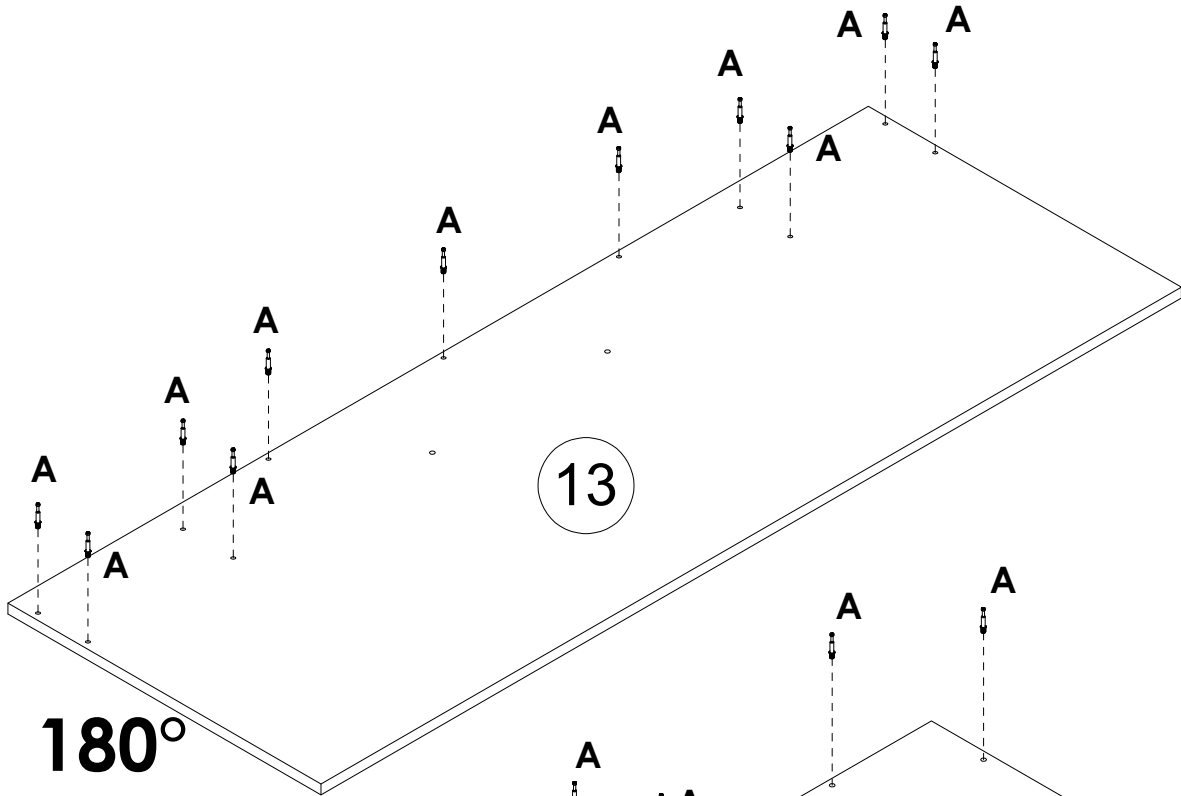
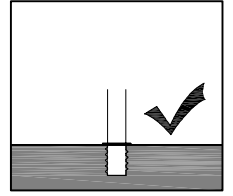
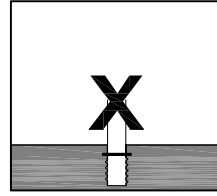
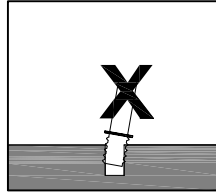
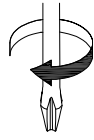

180°

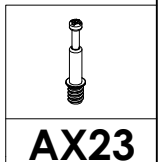
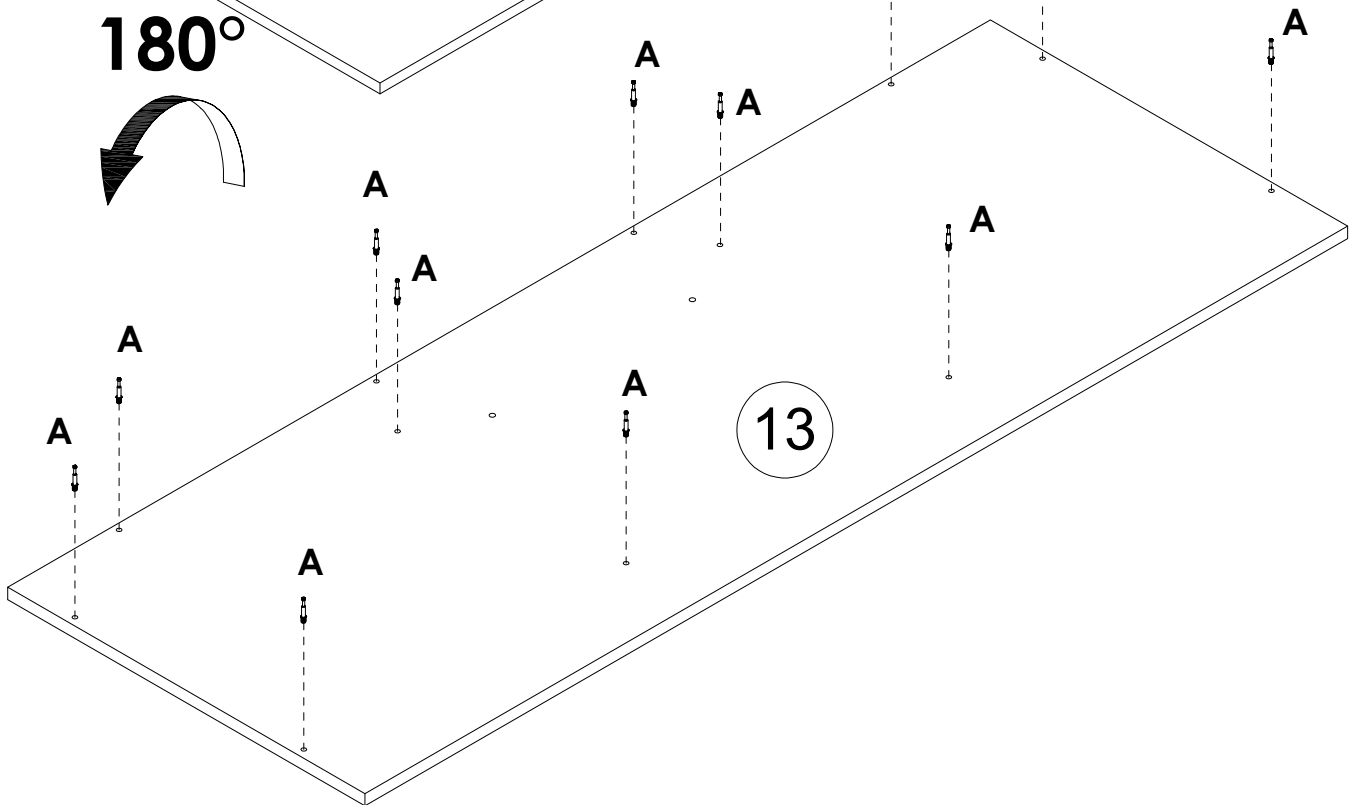
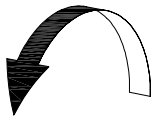

AX23

STEP 18

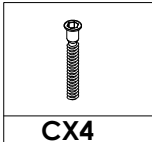
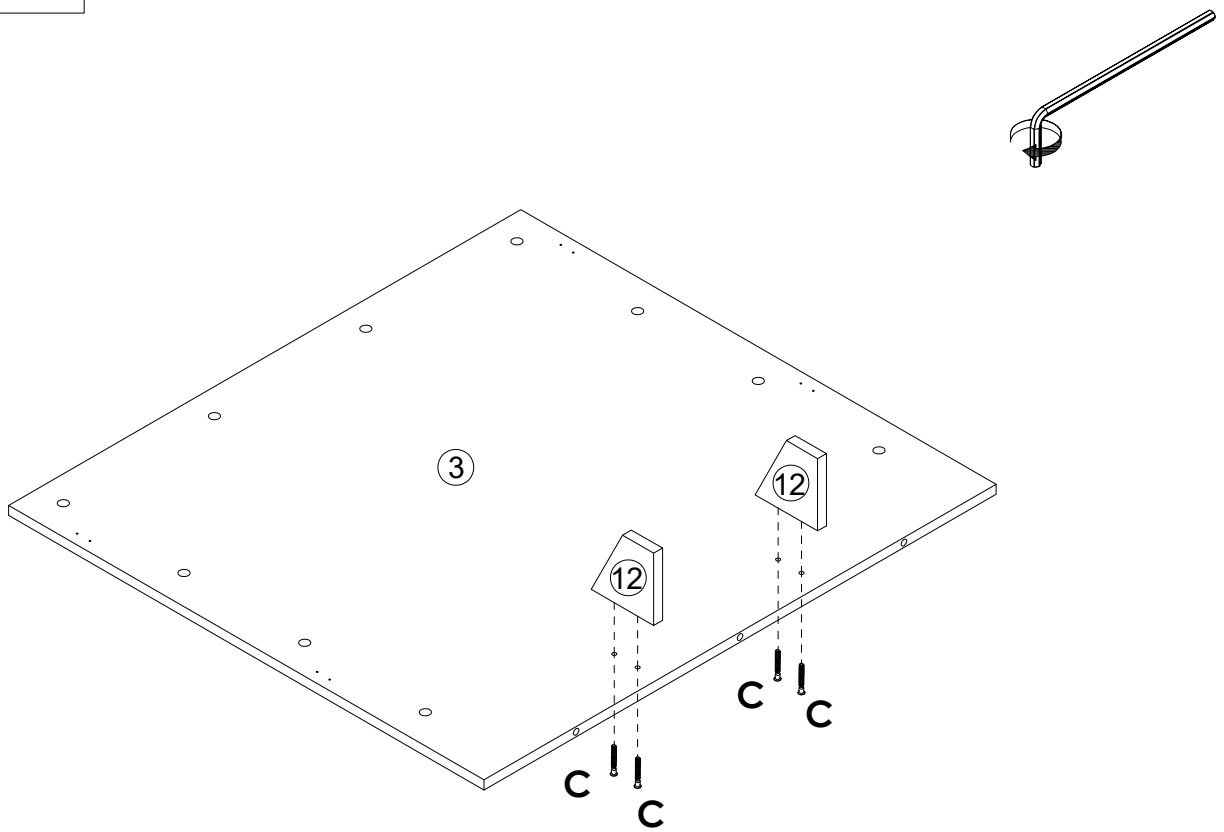

STEP 19

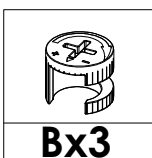
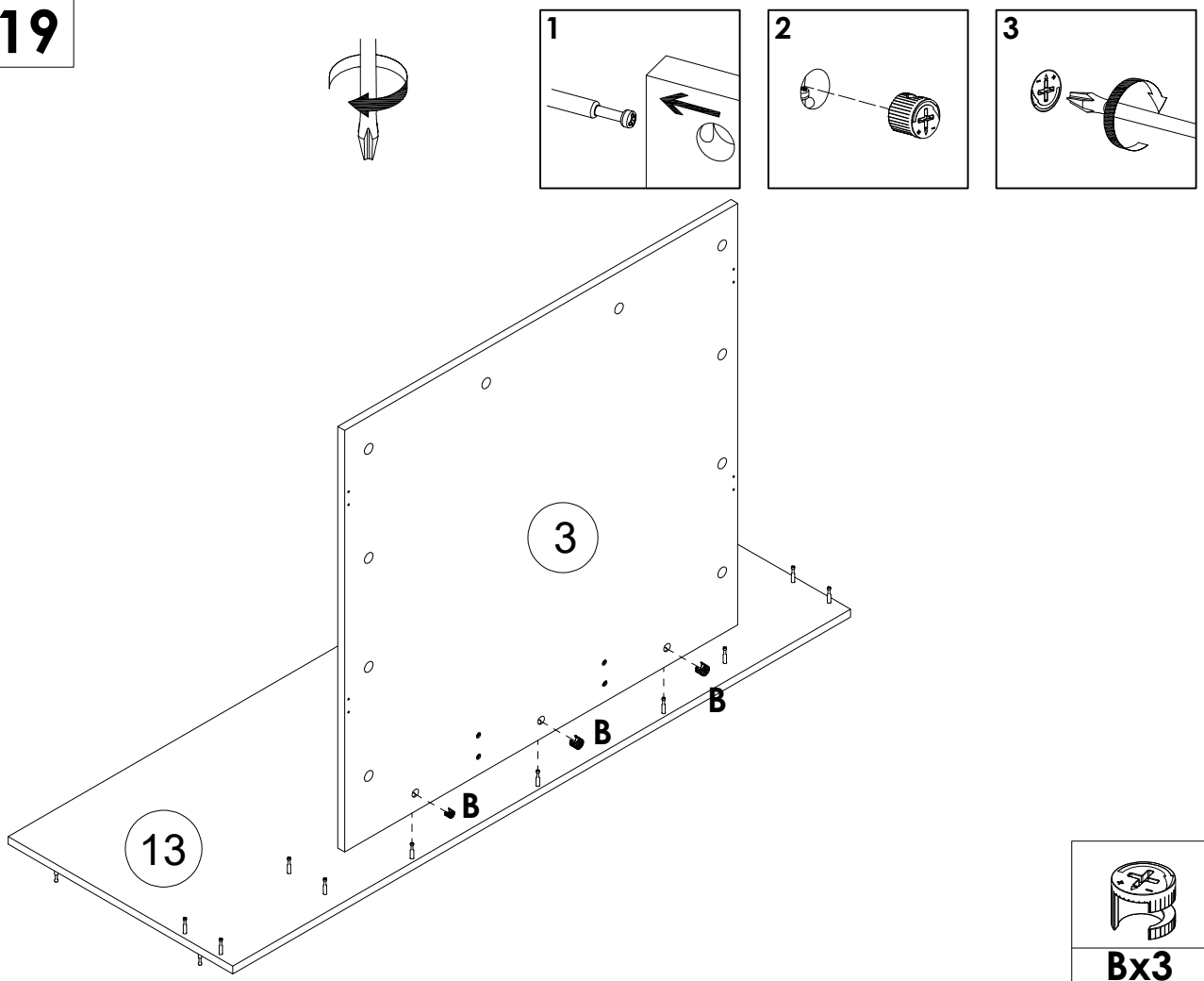

STEP20

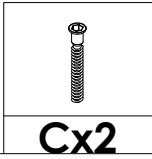
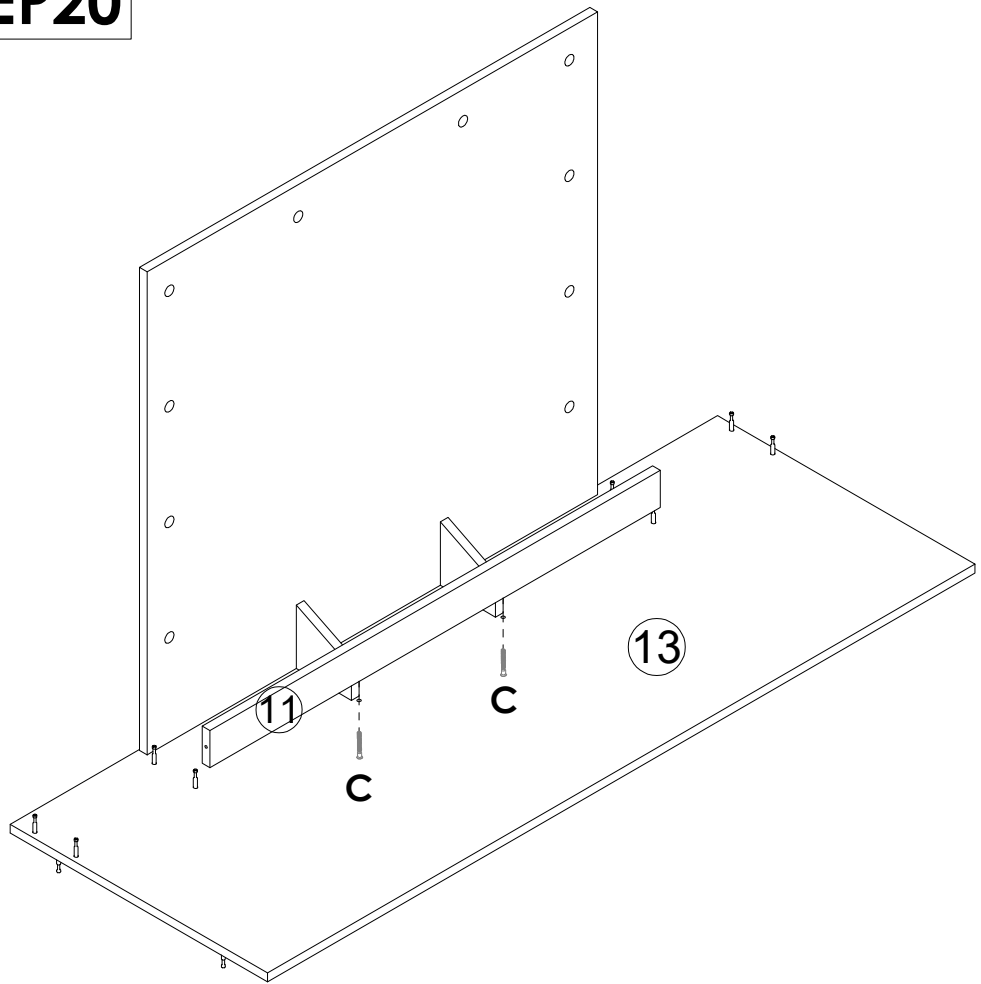

STEP21

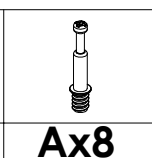
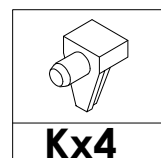
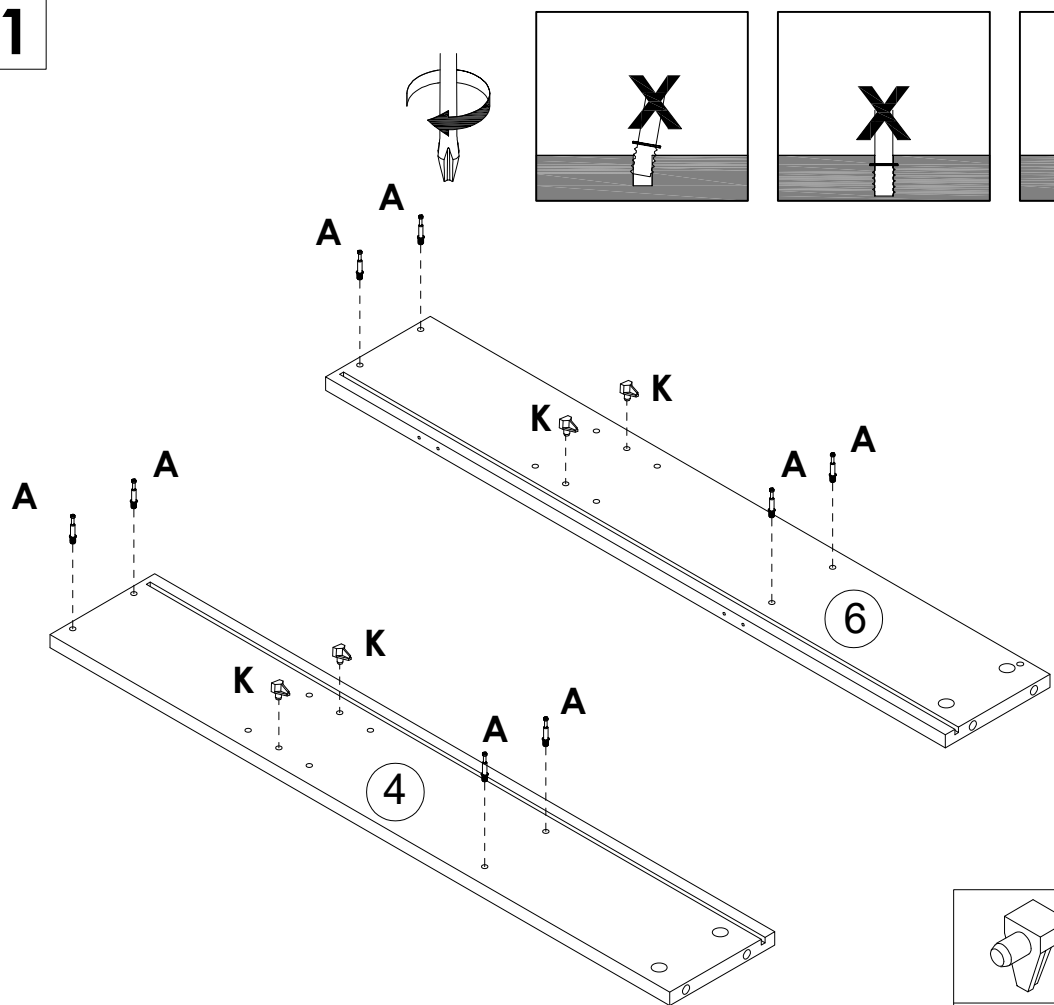

STEP 22

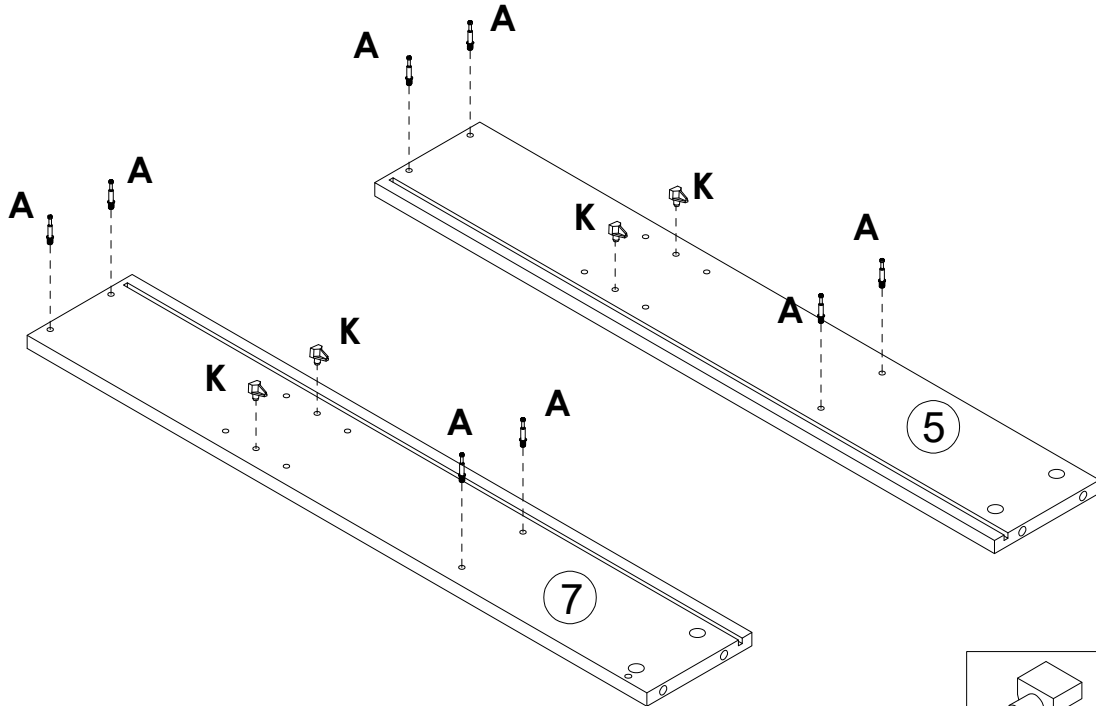
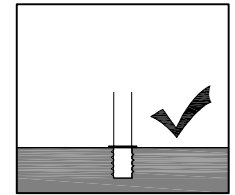
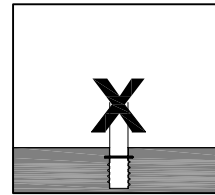
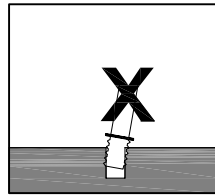
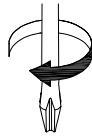

Kx4	Ax8

STEP 23

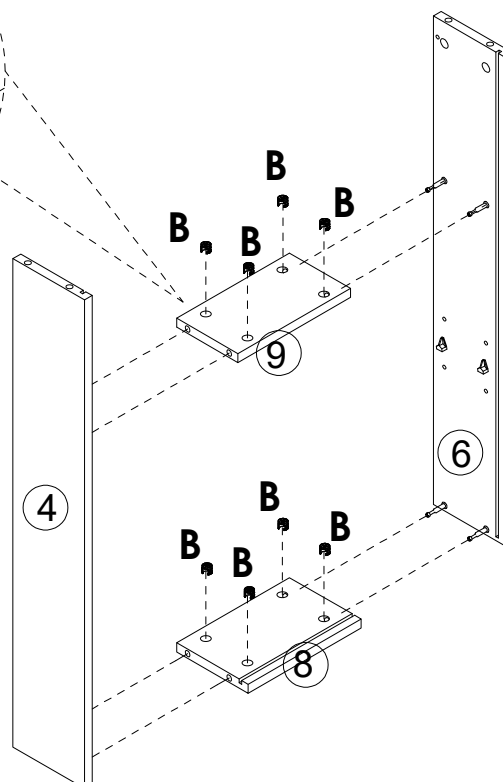
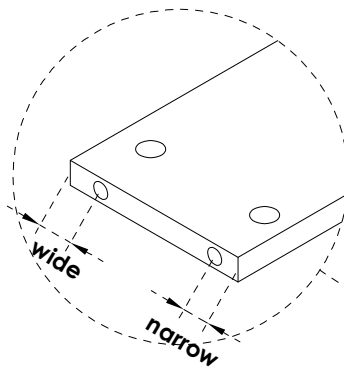
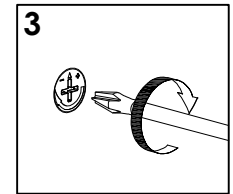
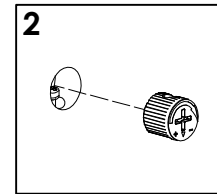
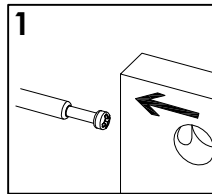
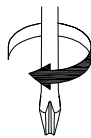

Bx8

STEP 24

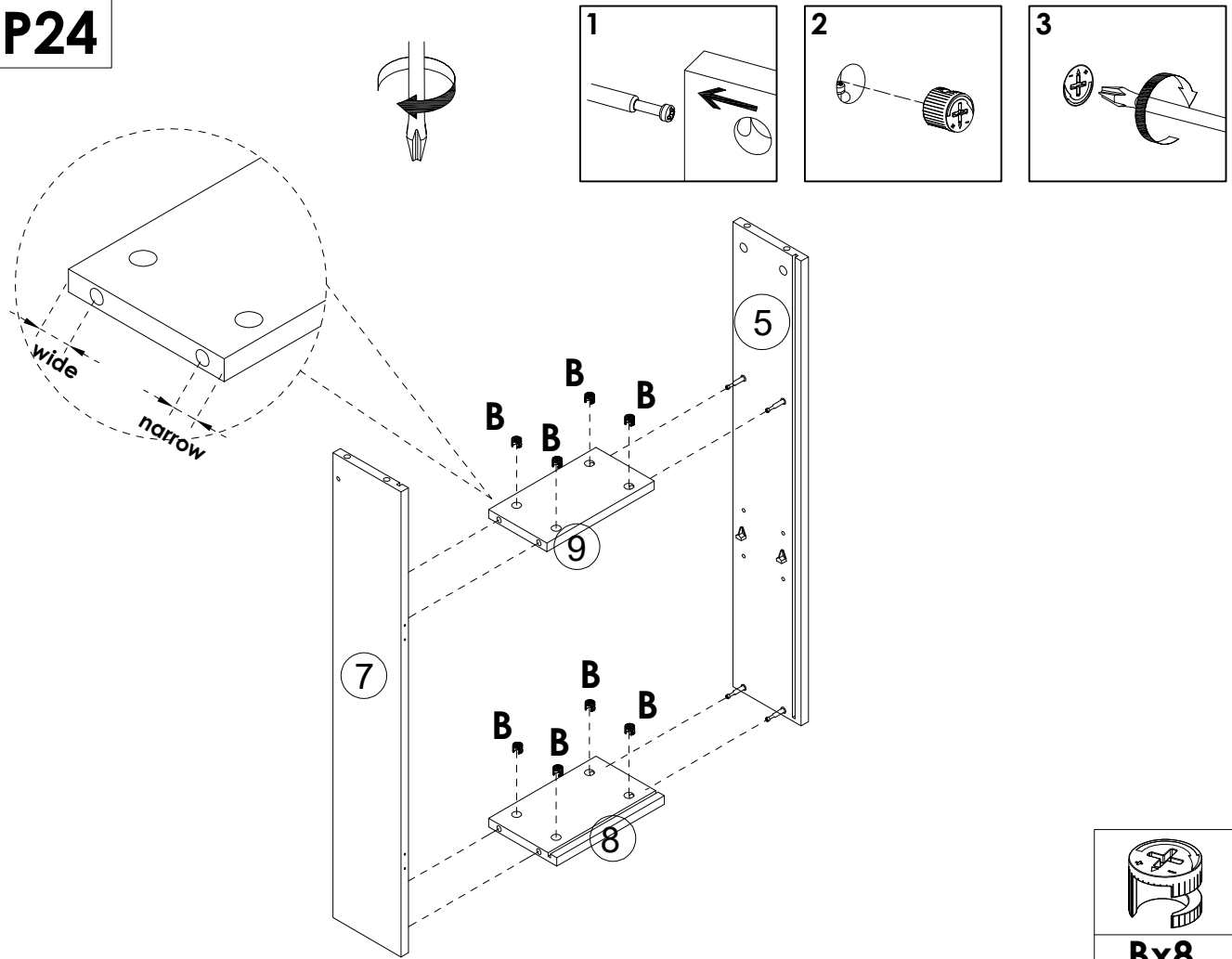

STEP 25

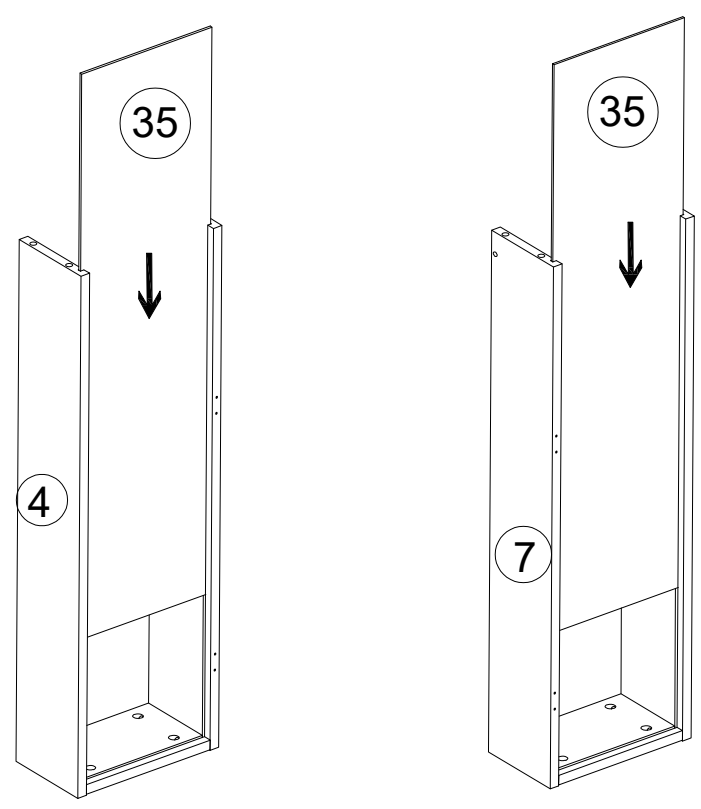

STEP 26

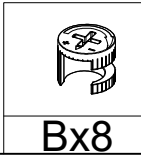
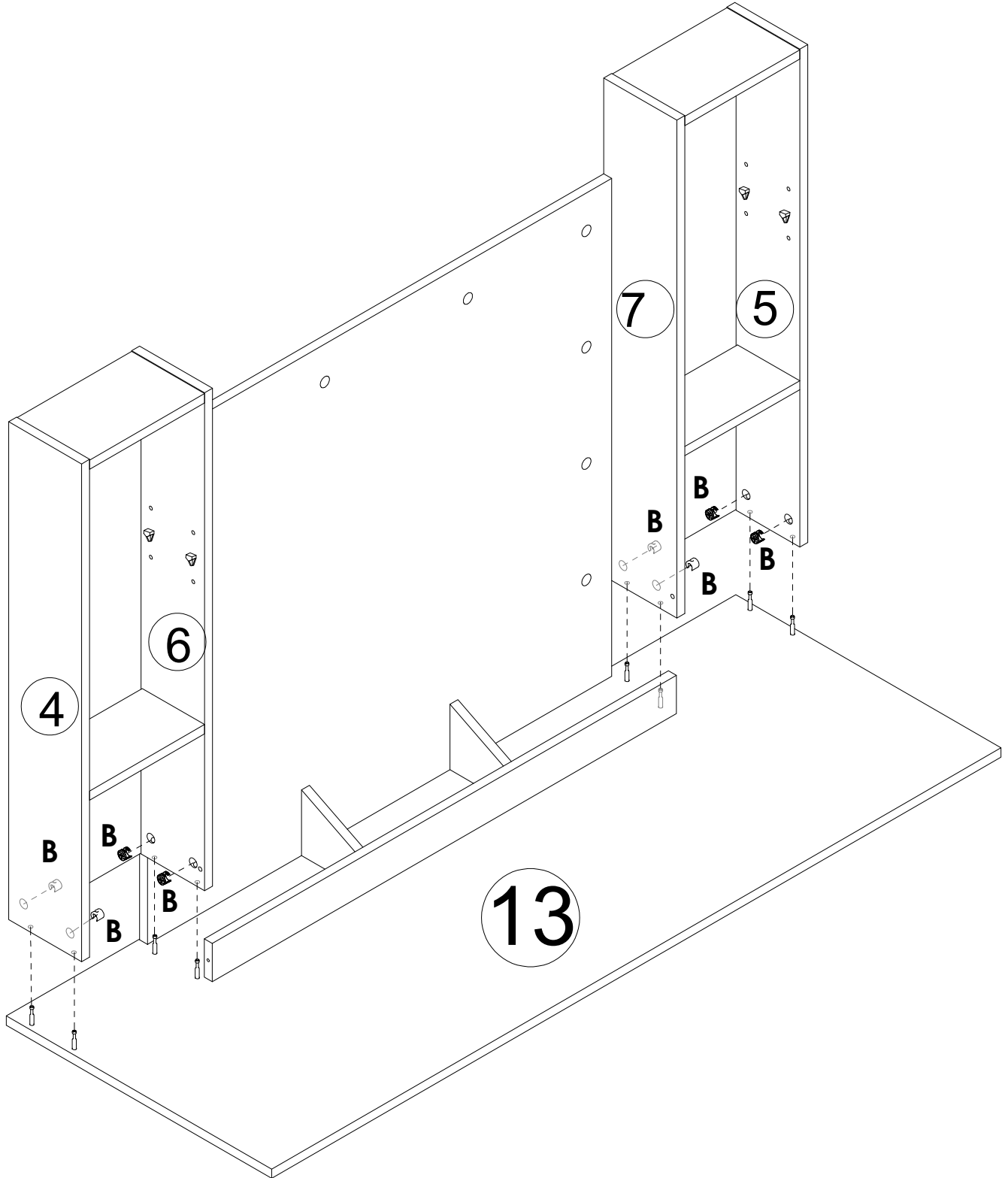
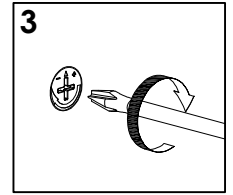
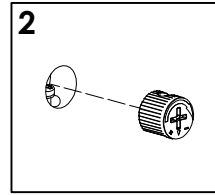
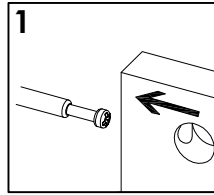
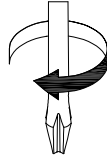

STEP 27

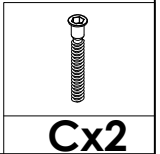
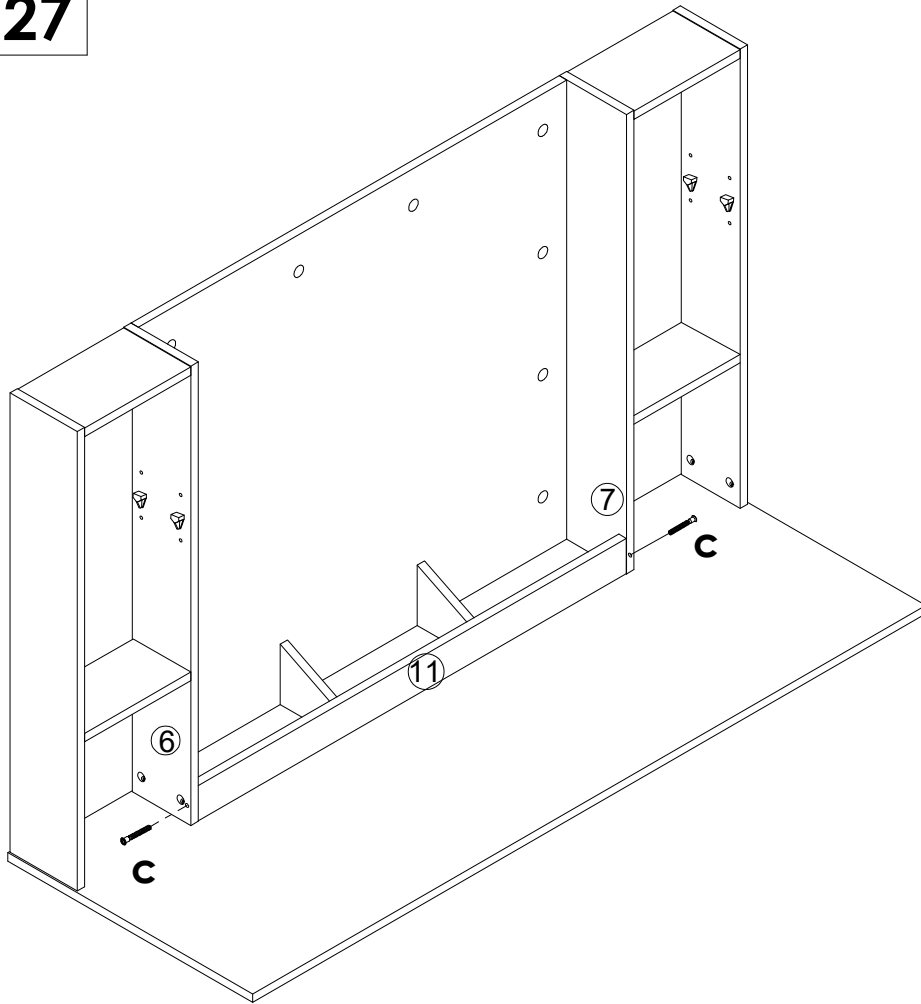

Cx2

STEP 28

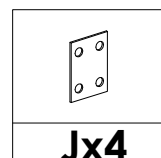
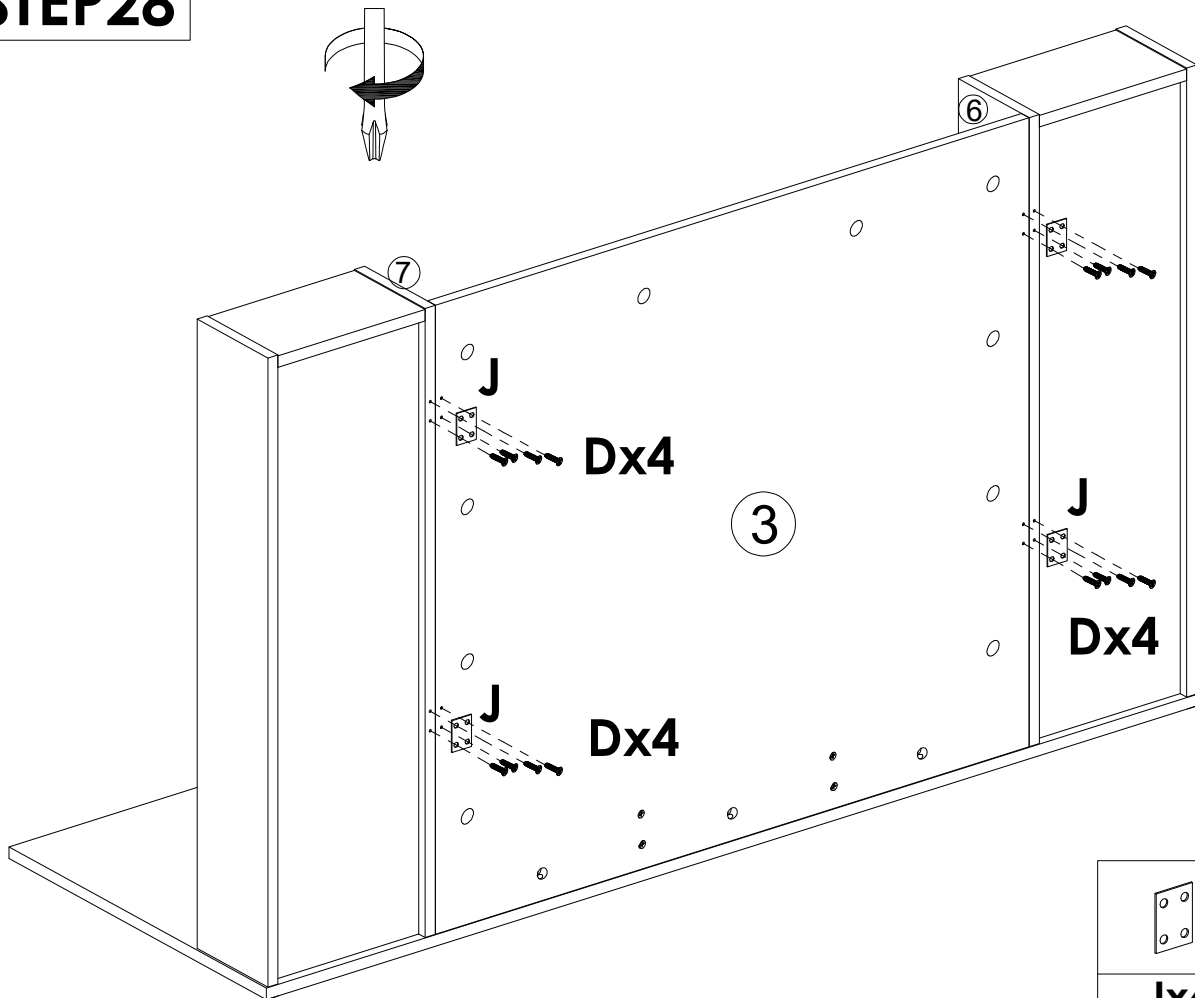

Jx4

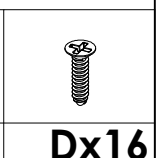

Dx16

STEP 29

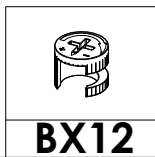
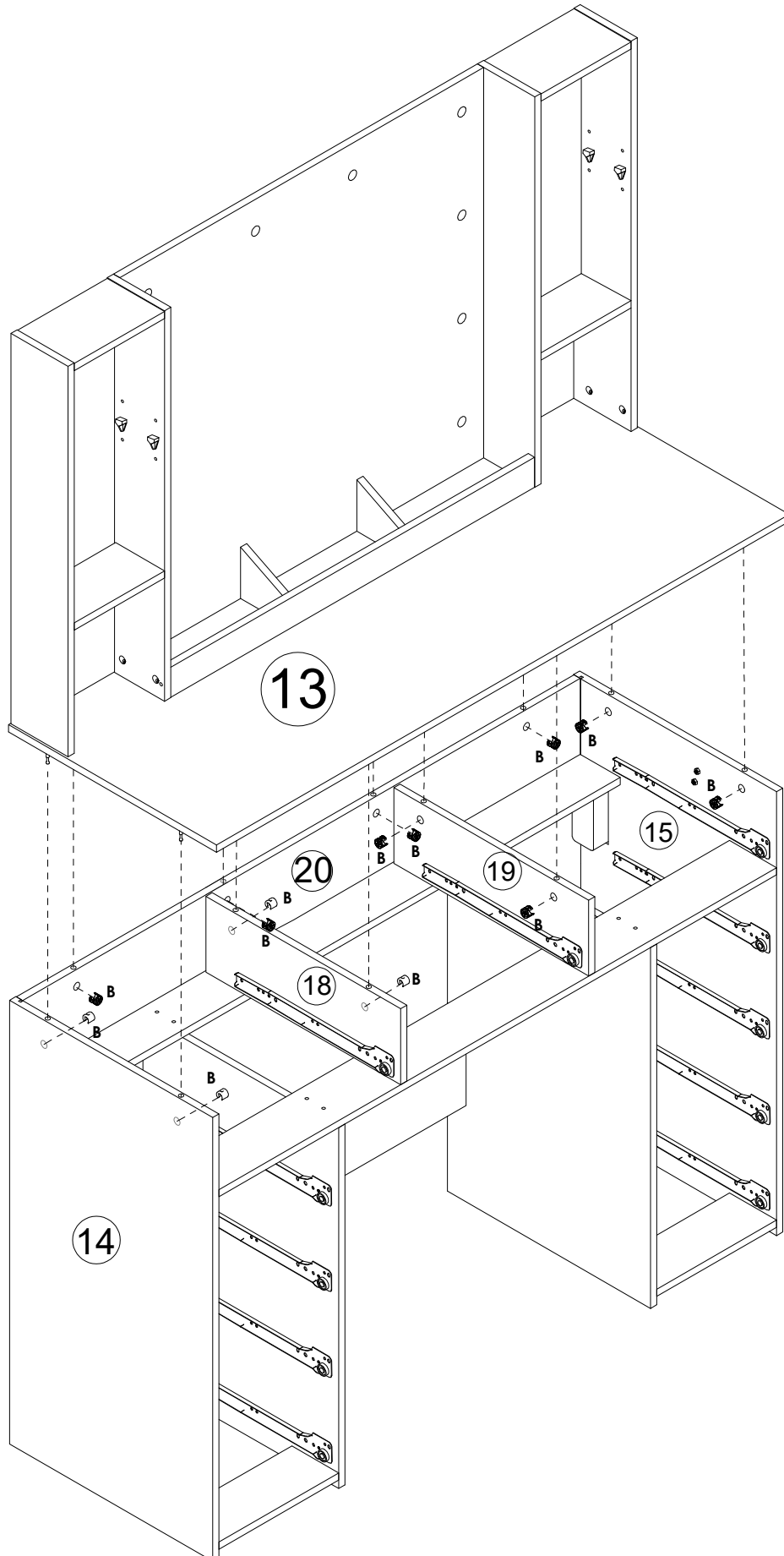
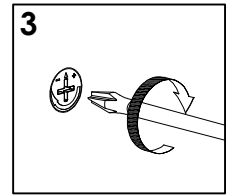
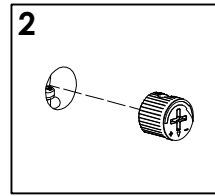
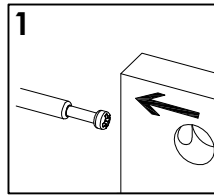
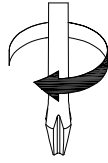

STEP 30x8

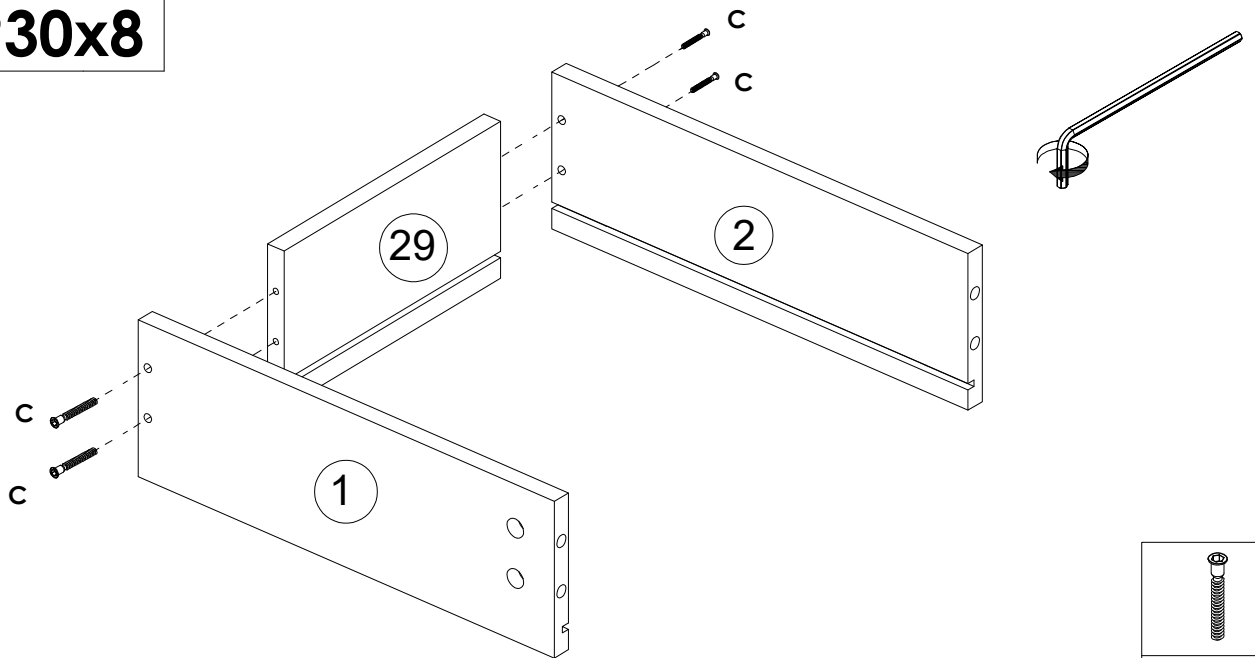

Cx32

STEP 31x8

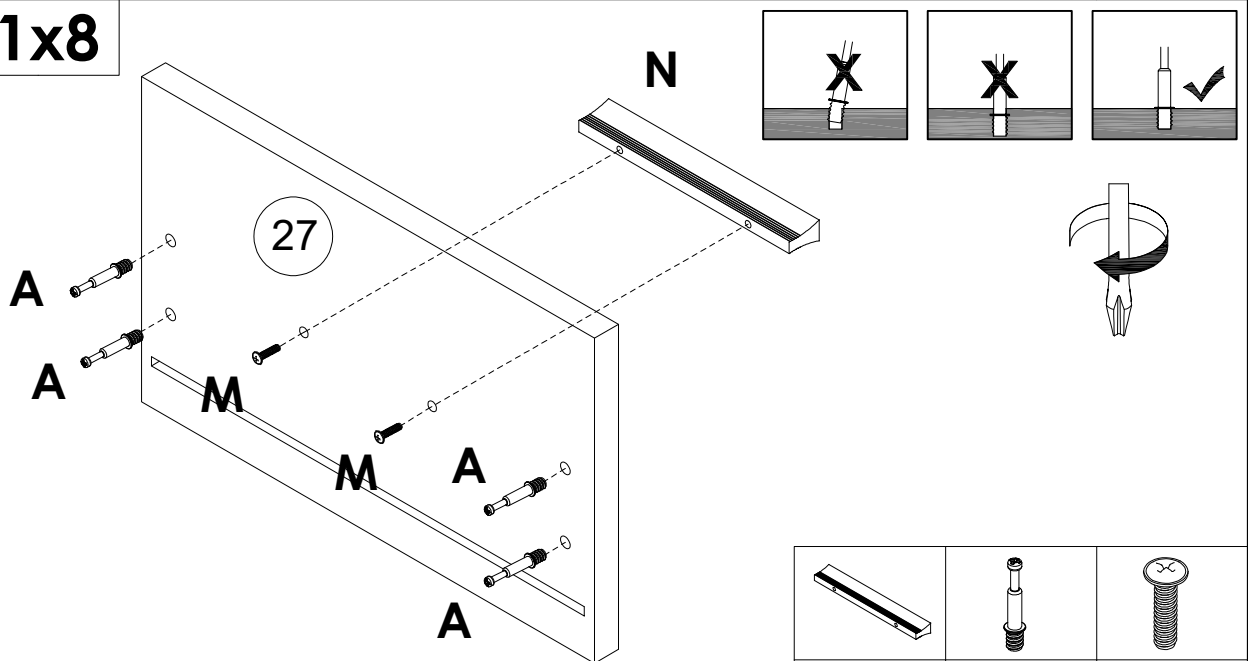

Nx8

Ax32

Mx16

STEP 32x8

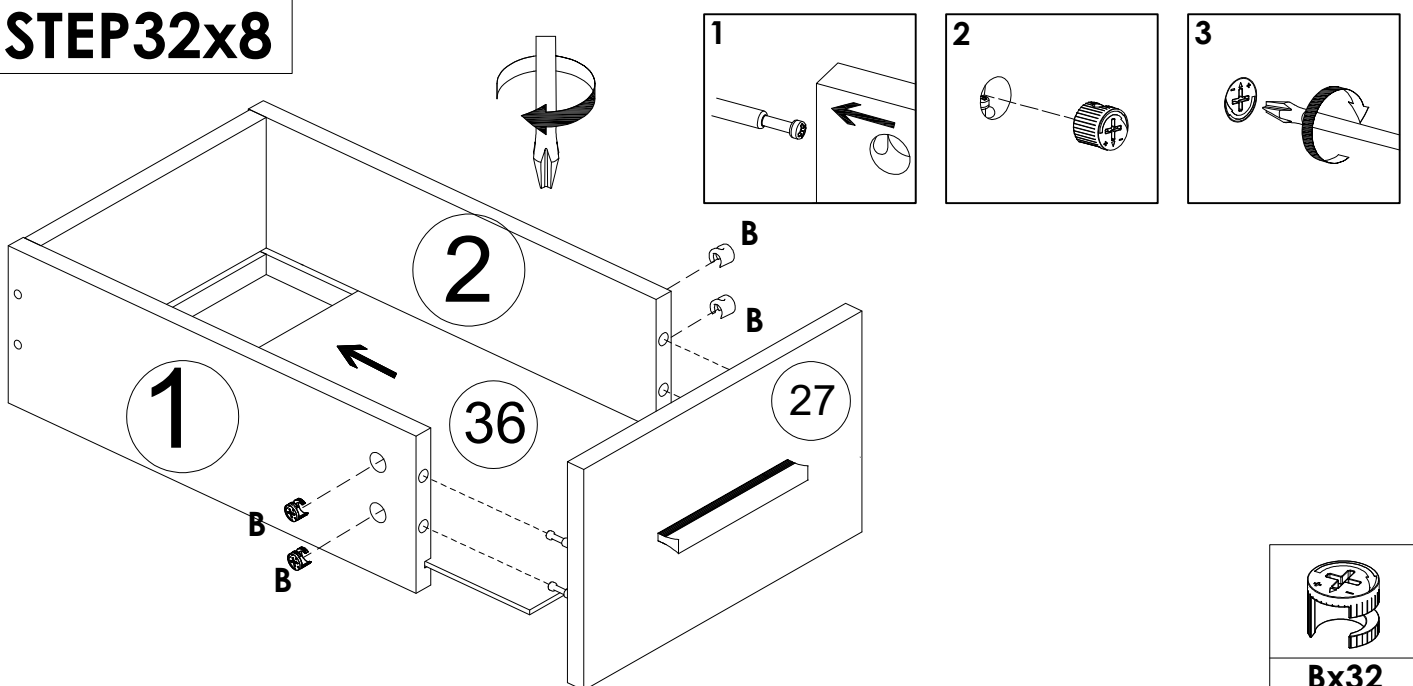

Bx32

STEP 33x3

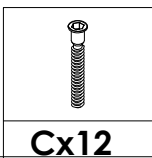
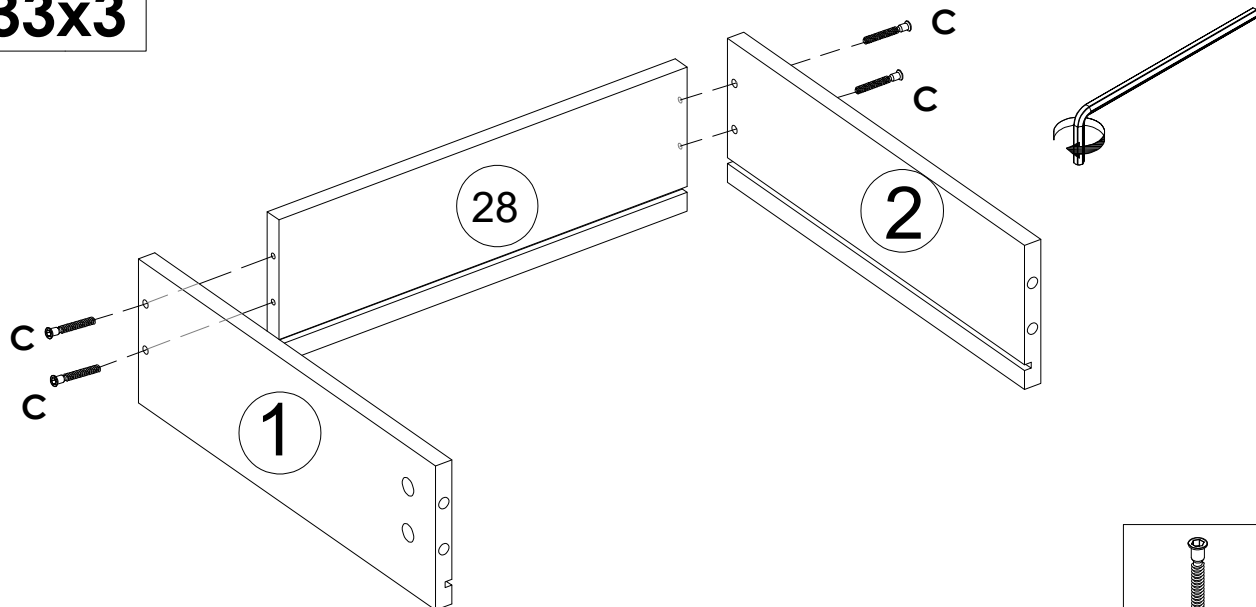

Cx12

STEP 34x3

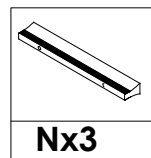
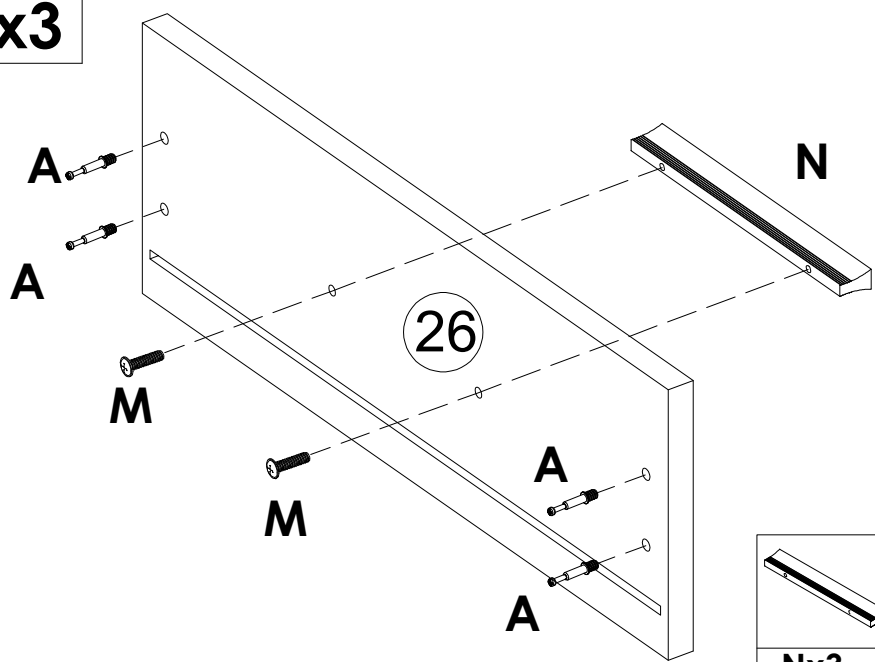

Nx3

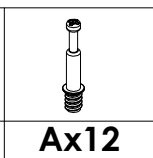

Ax12

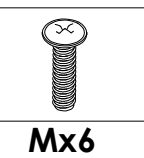

Mx6

STEP 35x3

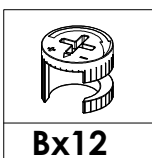
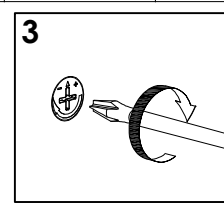
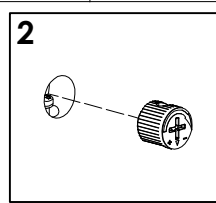
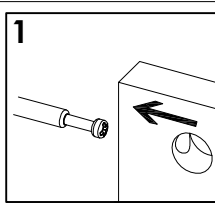
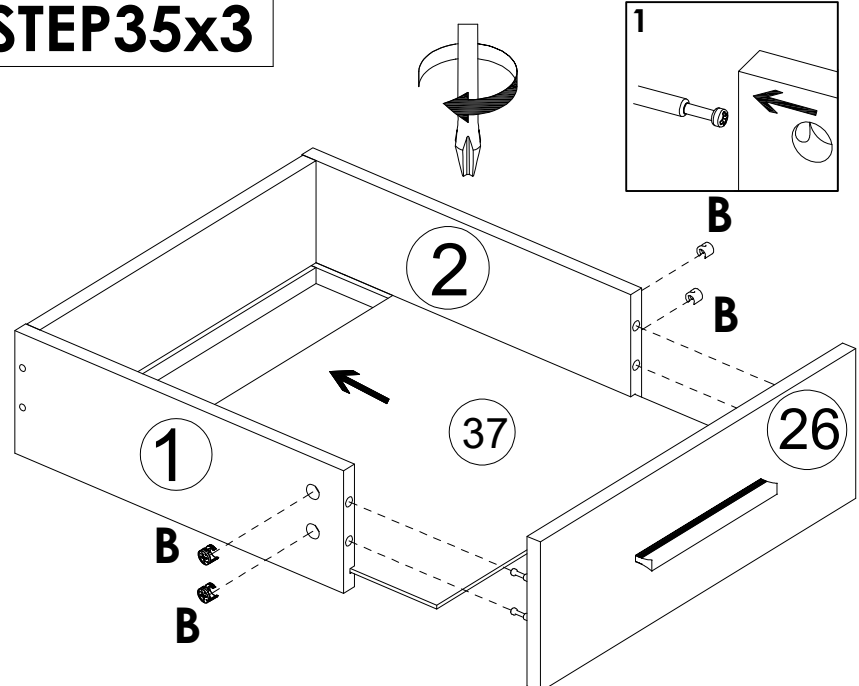

Bx12

STEP 36x8

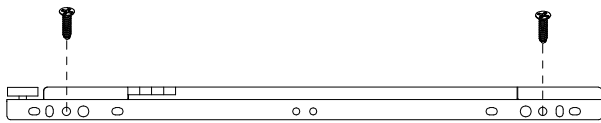
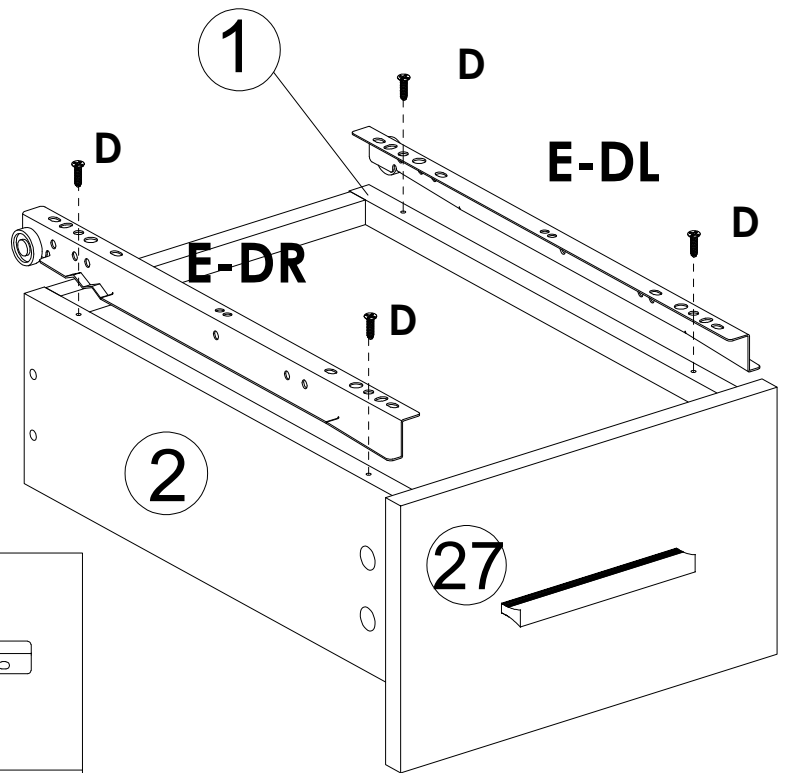
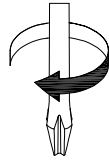

E-DLx8



E-DRx8



Dx32

STEP 37x3

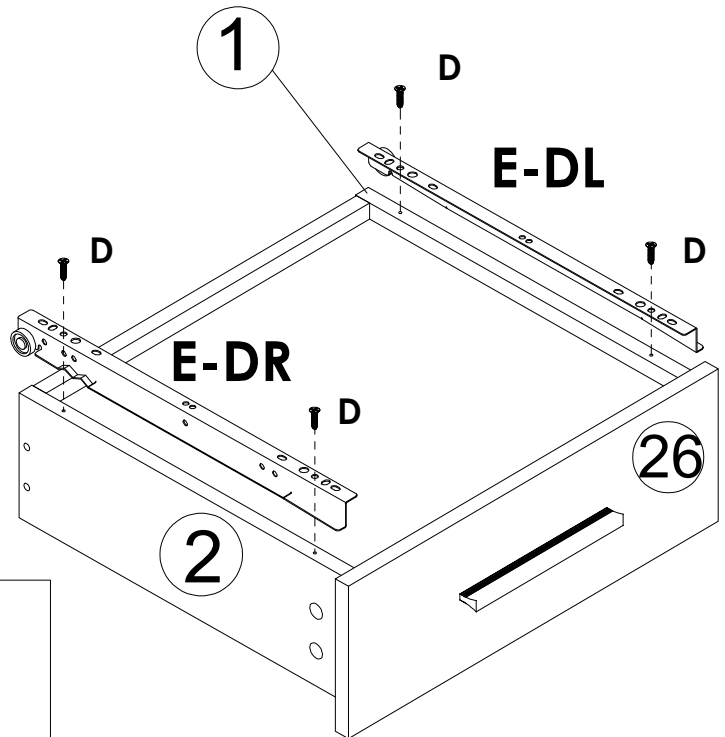
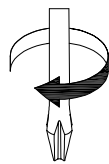

E-DLx3

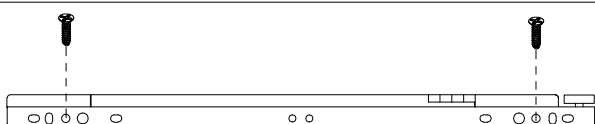

E-DRx3



Dx12

STEP 38

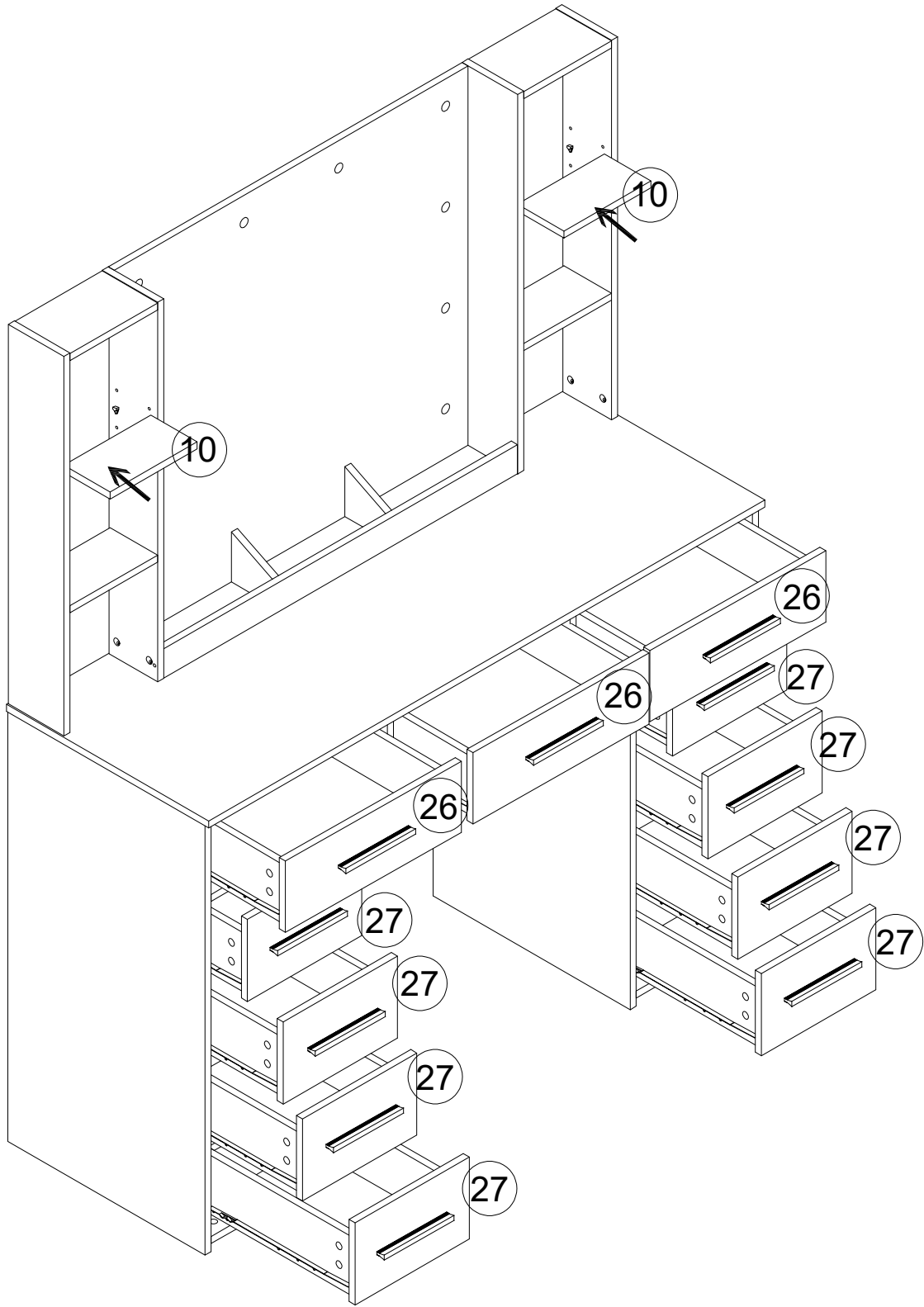

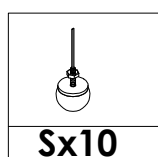
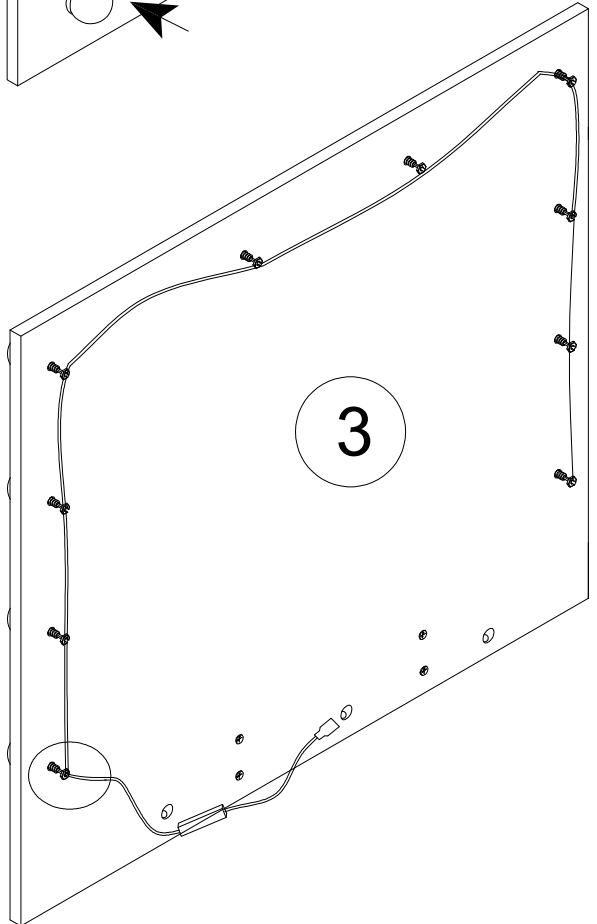
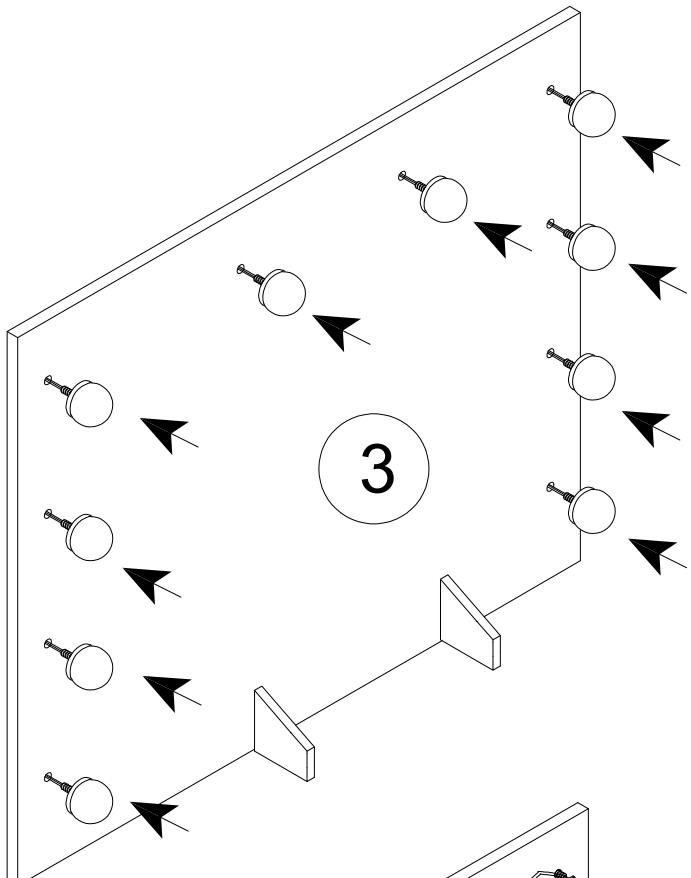
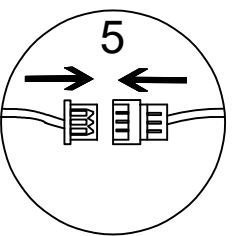
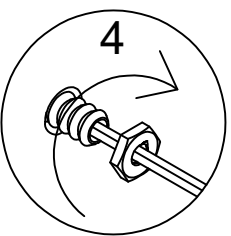
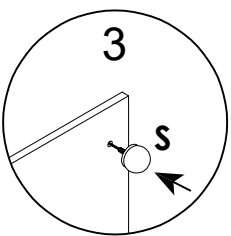
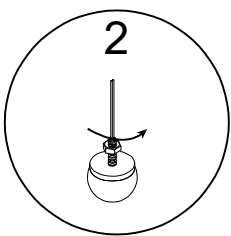
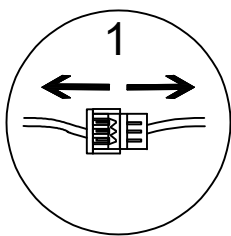

STEP39

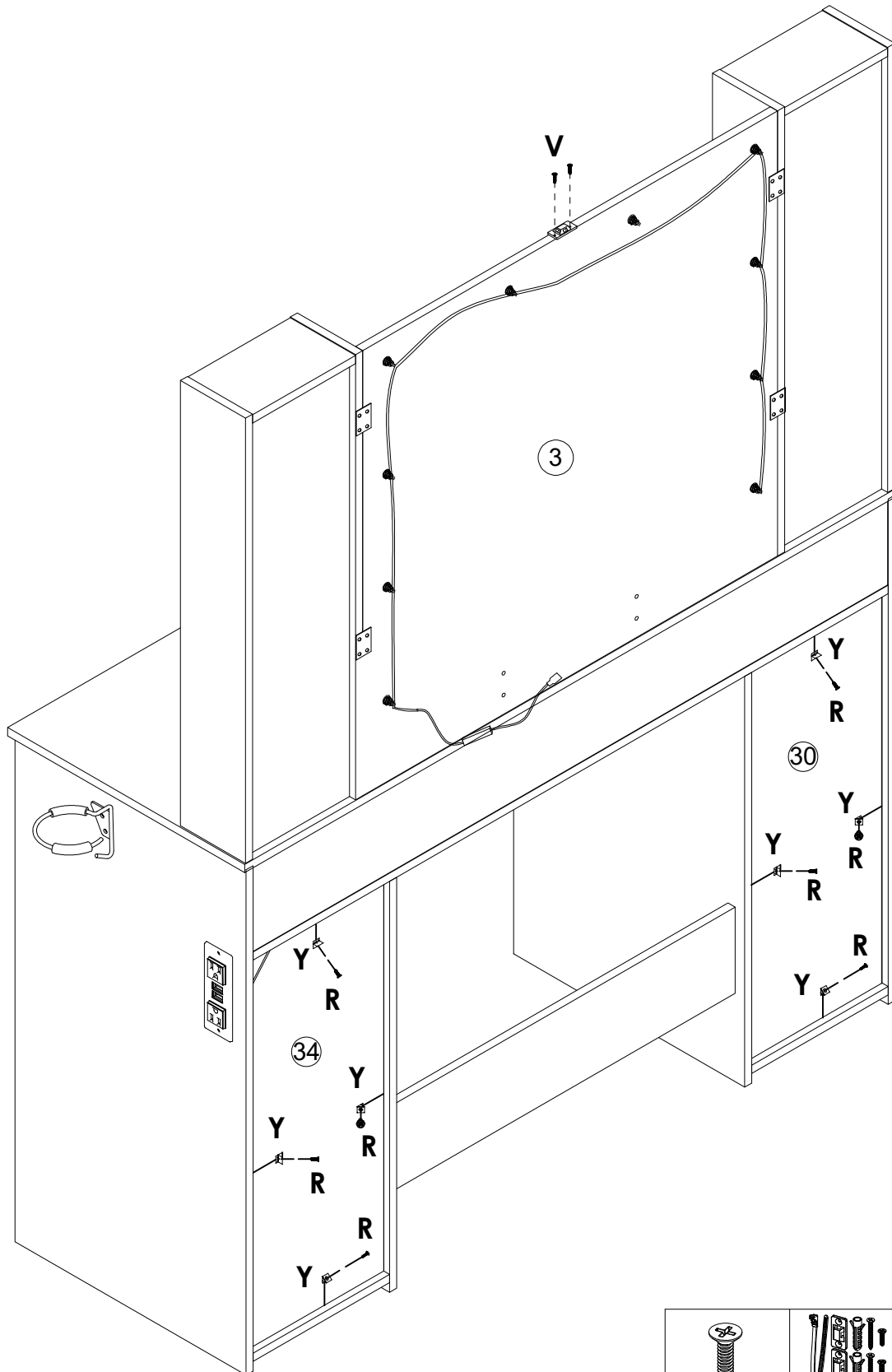
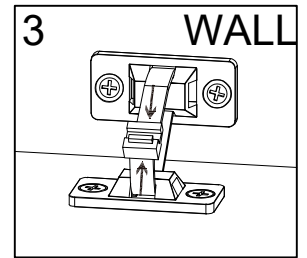
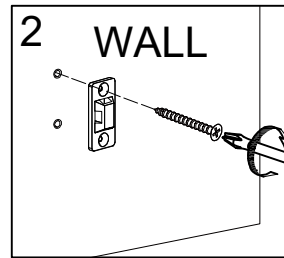
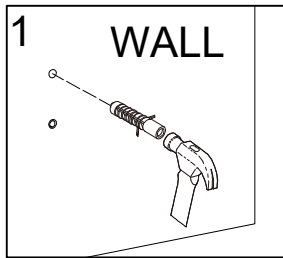

STEP 40



		
Rx8	Vx1	Yx8

STEP41

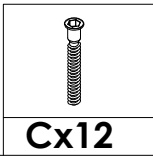
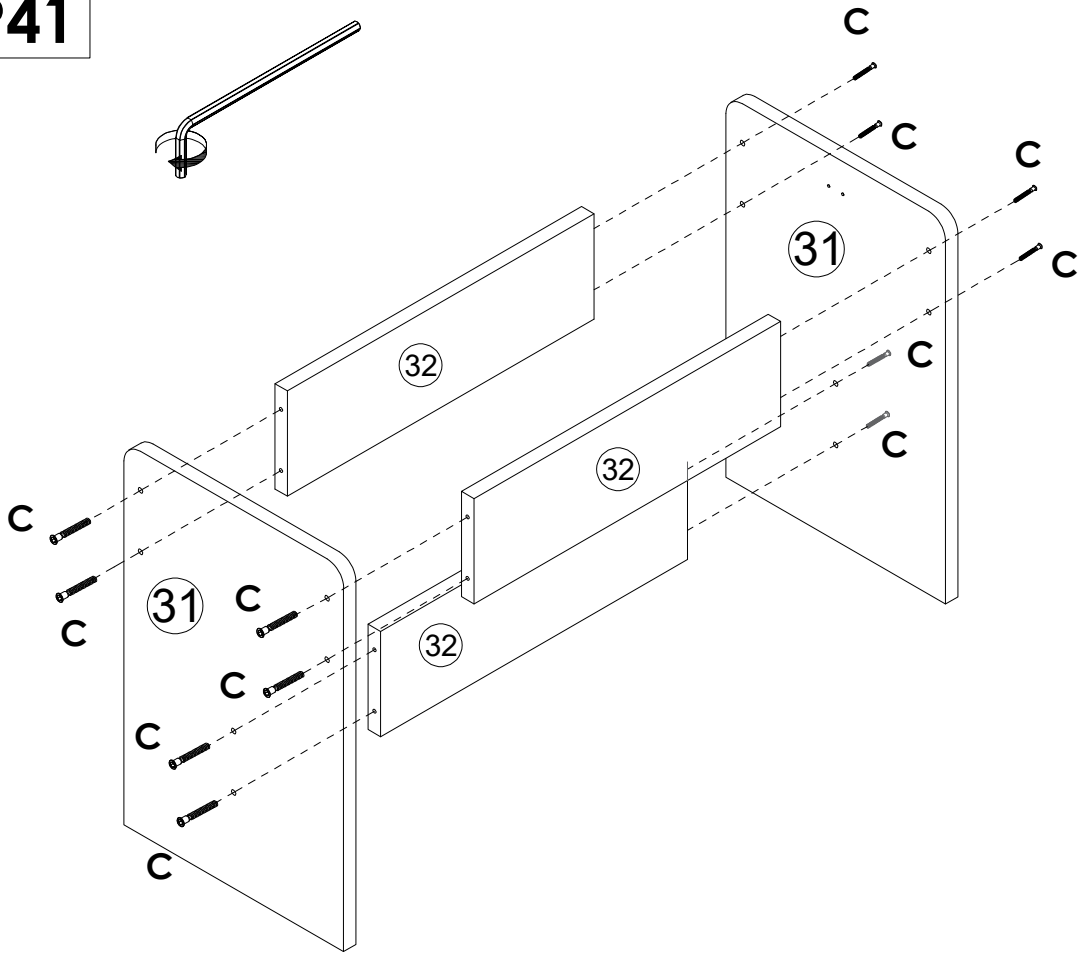

STEP42

