

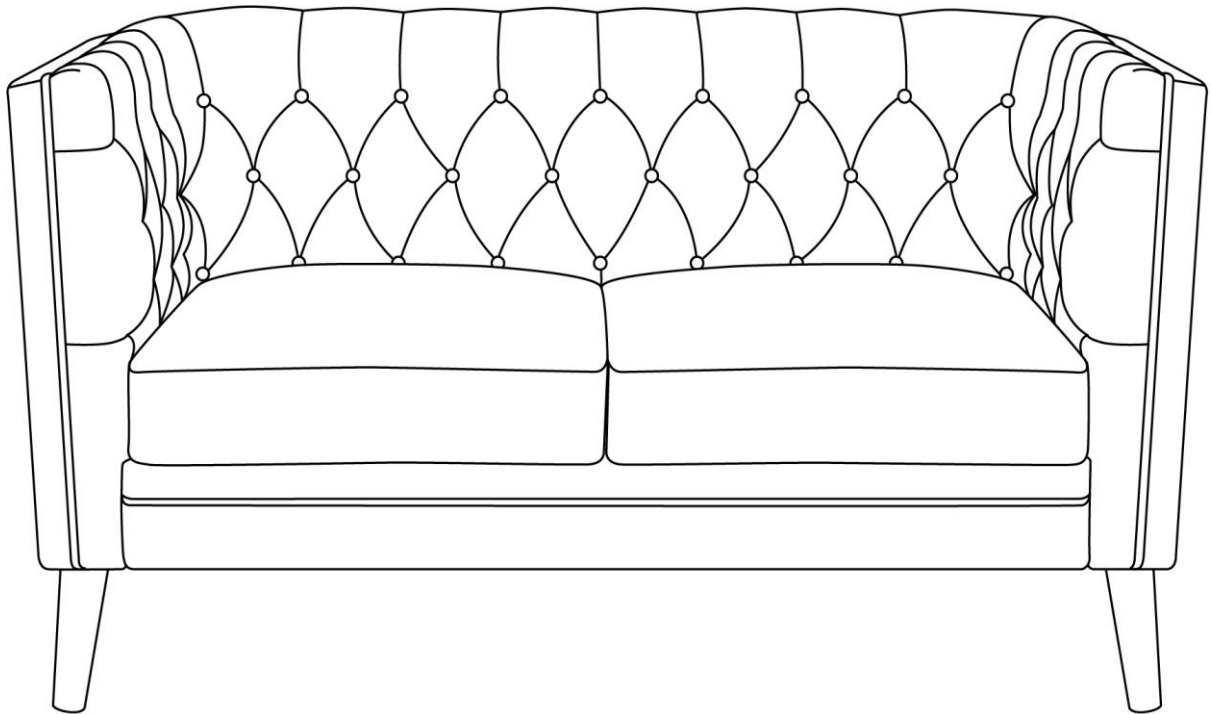

Assembly Instructions

Caution: You must read this before you proceed

Sofa

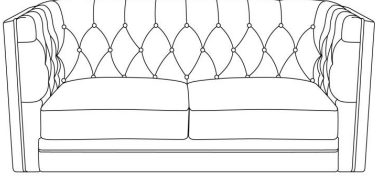

Part List

Label	Picture	Description	QTY
A		Sofa	1
B		Sofa Leg	4

Hardware

Label	Picture	Description	QTY
①		Gasket	7

Assembly Preparation

Before Beginning Assembly:

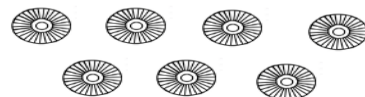
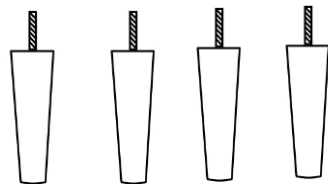
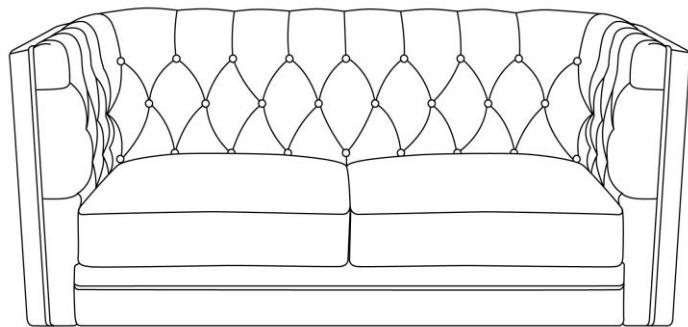

- Read instructions, cover to cover-



- Have 2 adults on hand for assembly-



- Do not assemble on flooring or carpet-



- Assemble on a clean non-marring surface (packing foam)-



- Save all packaging until finished-

Assembly Steps

Overview

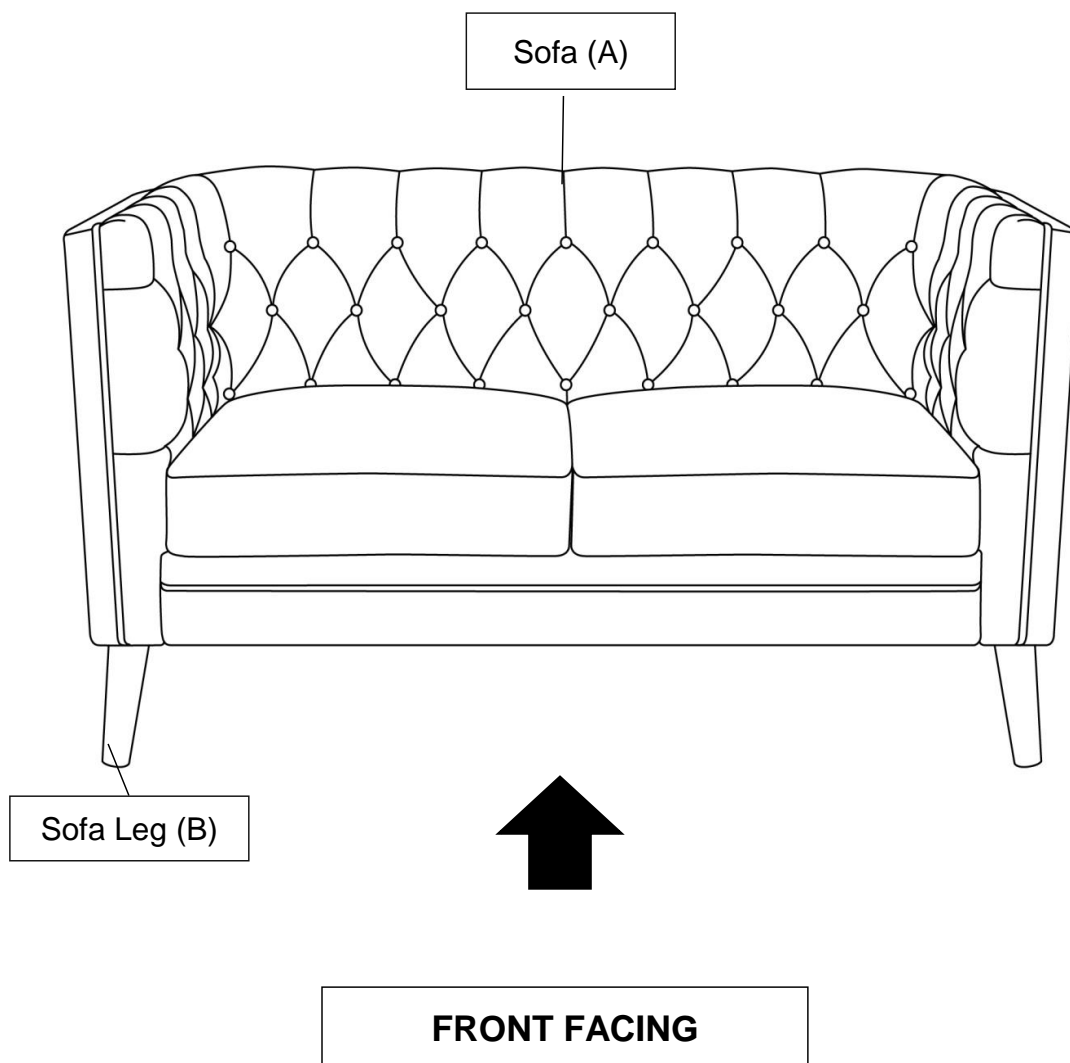

This Sofa has multiple parts and may require up to 30 minutes to assemble. To give you an overview of the Sofa parts, the above picture is to help you put the various parts into perspective. Please read through the instructions below to familiarise yourself with the parts and steps before assembly.

Note: It is recommended that you have an adult partner to assist during the entire assembly process.

Step 1

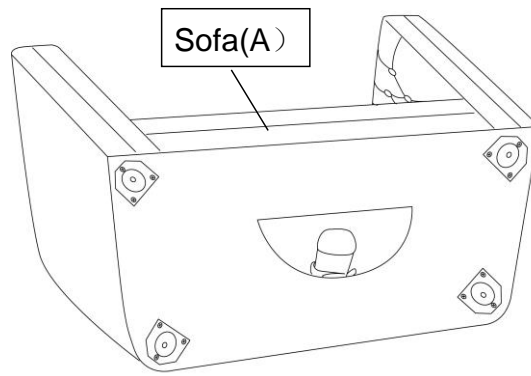

Position the Sofa(A) on its back, as shown.
Do not place on a surface that can scratch or damage the upholstery.
Unzip to open and remove the 4 wooden legs.
Close pouch before assembling.

Step 2

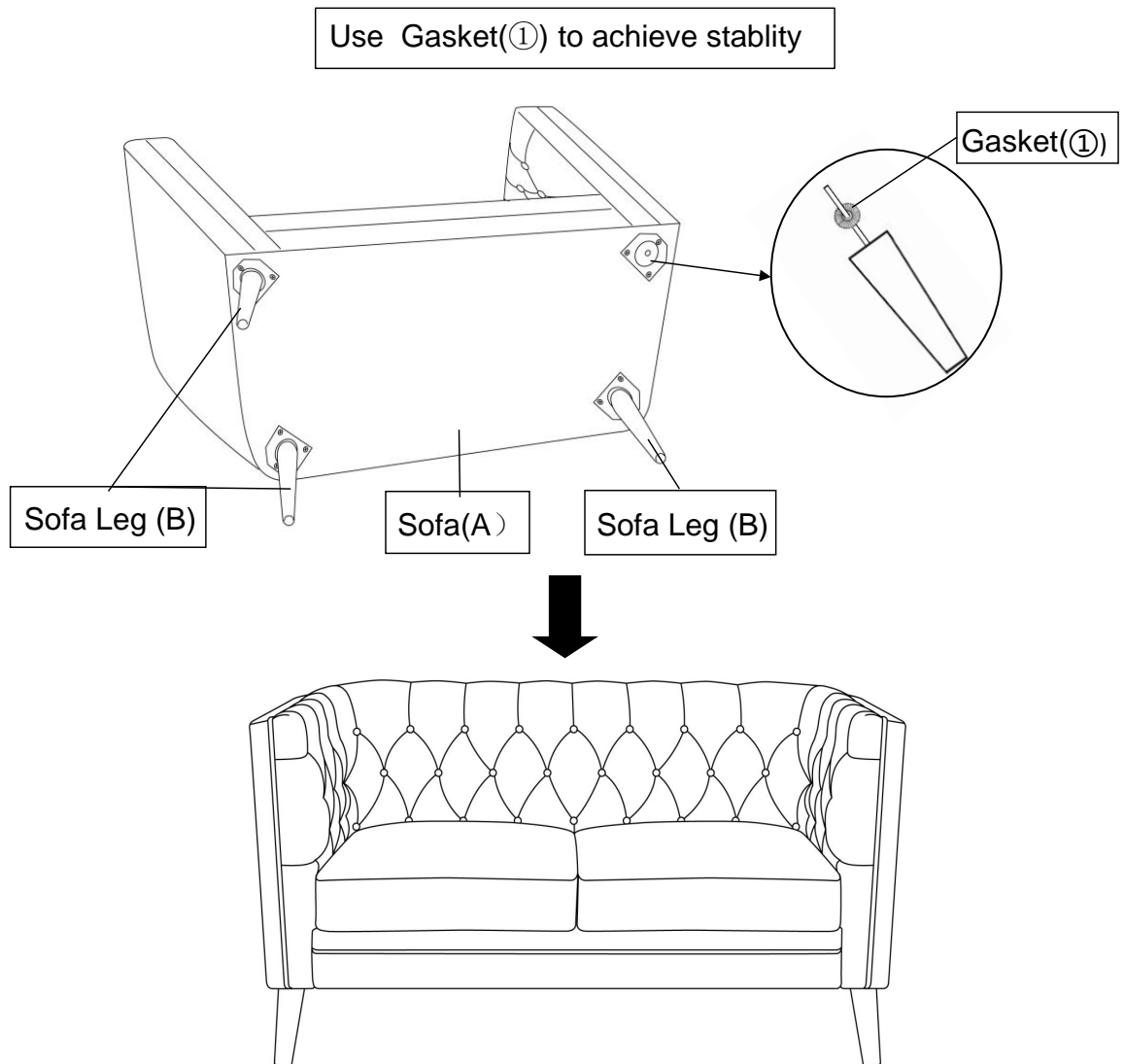

Install the Sofa Leg(B) at the bottom of the sofa by placing one Gasket(①) on the threaded stem.
Then insert the threaded stem into the threaded mounting position at the corner of the Sofa.
Tighten by turning the Leg clockwise.
Repeat the same step to install the remaining three Legs.

**Note: The use of Gaskets are OPTIONAL and are especially useful to help alleviate slight wobbles.
Some Legs may need more than one whilst some legs may not need any.**

Care & Maintenance



- Furniture may scratch floors. We recommend using furniture pads to protect your floors.



- Do not put hot items directly on furniture surface.



- Do not clean furniture with harsh cleansers or polish.



- Do not place furniture under direct sunlight.



- Do not place furniture near heating or cooling vents.



- Do not write on furniture without a padded barrier to protect the surface.



- Do not place furniture outside . For indoor use only.



- Not for commercial use. For residential use only.



- Stains may be removed with mild soap solution and damp cloth.



- Children should not climb or jump on the furniture.



- Dust and pick-up spills using a clean, non-colored, lint-free cloth.