

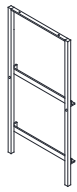

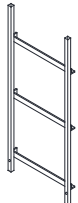

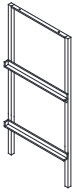

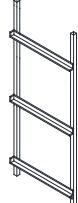



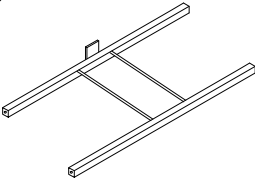
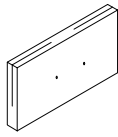
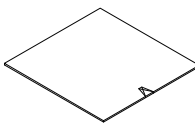
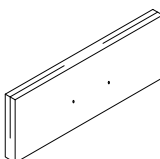
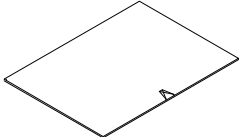
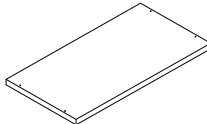

ASSEMBLY INSTRUCTION

- ①. Check out our Youtube channel for step-by-step installation video.
- ②. It would be best if you set aside and organize all pieces & corresponding "nuts/ bolts" first.
- ③. Please follow the instruction to assemble the item correctly.
- ④. Could be assembled by one person, but would recommend two.
- ⑤. Do not tighten the screws until all of them are in right positions.

SAFETY INFORMATION
The accessory bag contains some small accessories, which should be kept away from children.

A  X1	B  X1	C  X1	D  X1	E  X4 F  X2
G  X1	H  X2	I  X2	J  X4	K  X4
L  X1	M  M6x10mm X21	N  M6x28mm X8	O  M4x6mm X12	P  X6
Q  X4	R  X4	S  M6x23mm X4	T  X5	U  X1 V  M6x16mm X1 W  X1

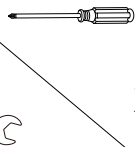
1

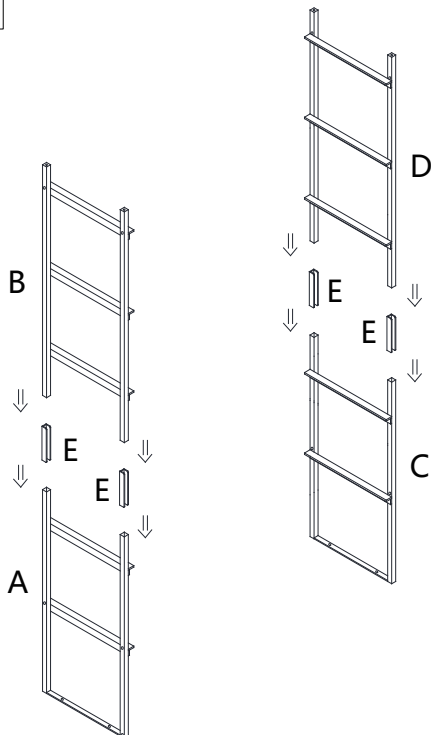

E x4

2

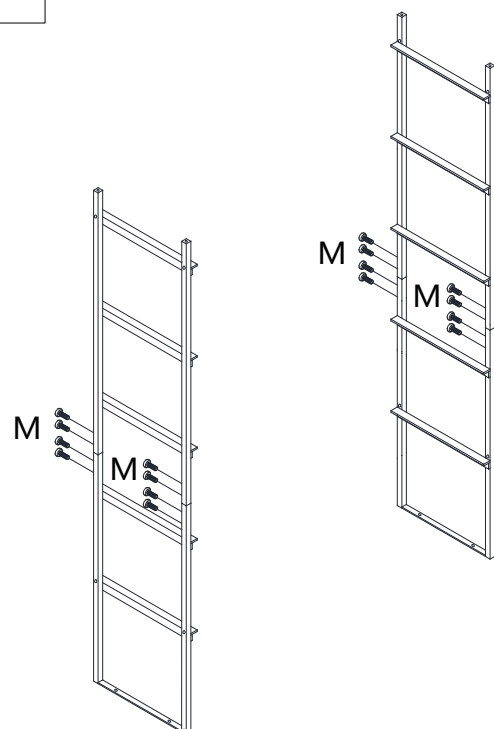

M M6x10 x16

3

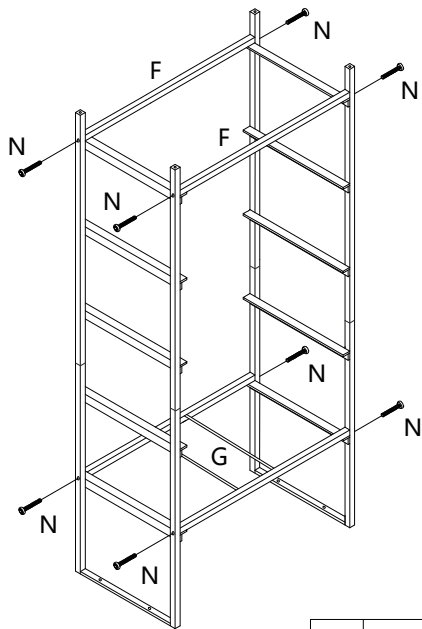

N	M6x28	x8
---	-------	----

4

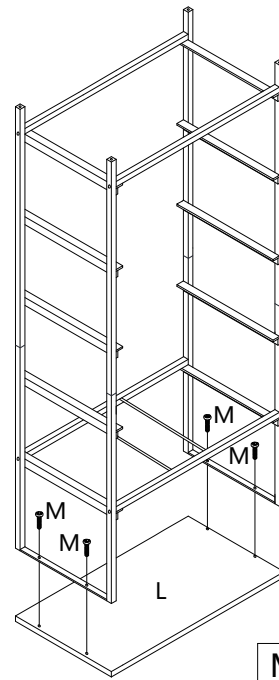

M	M6x10	x4
---	-------	----

5

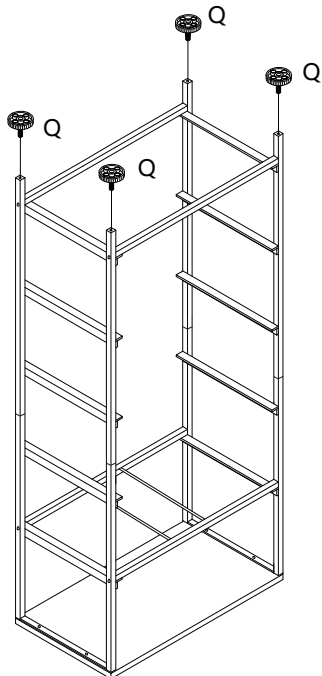

Q	x4
---	----

6

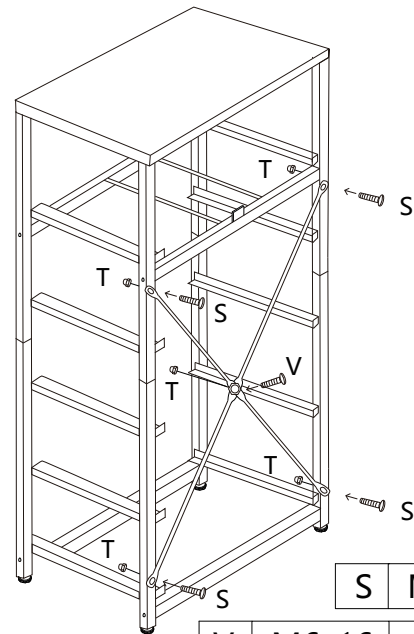

R	x4
---	----

S	M6x23	x4
---	-------	----

V	M6x16	x1	T	x5
---	-------	----	---	----

7

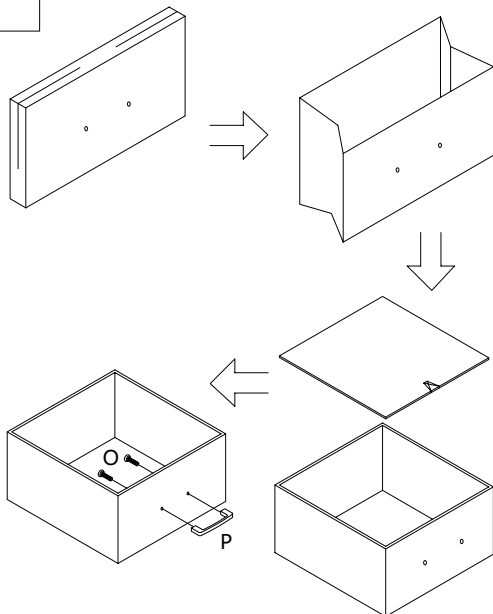

O	M4x6	x12
---	------	-----

8

